

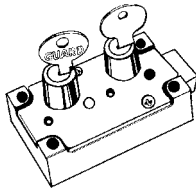

SAFES & SAFE LOCKS

SECTION 15



SAFES

Index

A	
ATM Locking Systems	26
Auditcon Lock Series	22- 23
C	
Cencon System 2000	26
D	
Dial & Ring Sets	21
Dial Rings	20
E	
Electronic Safes	13, 14
F	
Fingerprint Safes	15
Fire Cabinets	9-10
Fire Resistant Chests	14
Fire Resistant Safes	14
H	
Hide-A-Buck	3
P	
Personal Safes	2

S

Safe Deposit Locks	27
Safe Dials	20
Safe Handles	27
Safe Locks	16, 21

V

Vendors

ADESCO	2-7
BUDDY	8
DIEBOLD	28
FIREKING	9-10
HPC	8
ILCO	28
KABA-MAS	22, 23, 25, 26, 27
PERMAVAULT	11-12
PRO-LOK	14-15
PRO LOK	13
Sargent & Greenleaf	16-21, 28

W

Wall Safes	8, 11
------------	-------

X

X-09™ High Security Locks	24
---------------------------	----





EX0915 Personal Safes

- Available in Black or Camouflage
- Cover opens automatically when you enter your code
- Light enough to be easily carried
- Two mounting plates included
- Simple mounting system allows you to install mounting plates on a variety of surfaces. Easily removed from the mounting plates with proper entry code.
- When lock is closed, incorrect entry code will be rejected and a buzzer will sound. A third incorrect code starts a 5-minute timer, during which no codes will be accepted.
- When any key is pressed, the keypad lights up
- Operates on 4 AA batteries
- Features a low battery alarm & mechanical override key.

Interior: 7³/₄ H x 10¹/₄ W x 2³/₄ Deep
 Exterior: 9" H x 15" W x 3¹/₂ Deep
 Weight: 16¹/₂ lbs.

Order #	Item #	Catalog Price
021-0040	EX0915 Black	\$330.00
021-0045	(U) EX0915 Camo	330.00

How to Pick the Right Adesco Safe:

- **Pick your safe's location.** In the floor, in the wall, in a closet, or free standing.
- **Pick your size.** What will go into the safe? Papers, jewelry, cameras, firearms, cash, etc. Plan for plenty of room here. It is cost effective to invest in a larger size now than to run out of space later.
- **Pick your level of security.** B-rate, C-rate, TL-15, TL-30, or fire safe.
- **Pick your door.** Deposit slot, key or combination.

Small Business Deposit Safes

Mini-Safe Set, Single nose

- Ideal for cash-based businesses
- Compact size and easily mounted
- Installation allowed near cash registers to permit frequent cash drops.
- Key lock
- Graphite finish
- Solid formed steel body

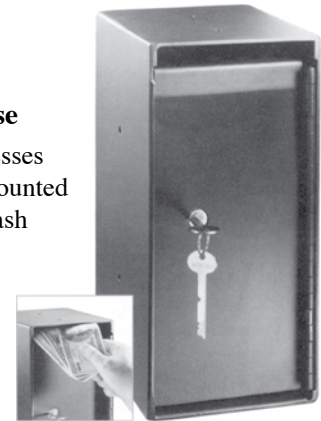

Interior: 10⁵/₈ H x 6" W x 6" Deep
Exterior: 12" H x 6" W x 7" Deep
Door opening: 1/2 x 3"; 383 cu. inches. Wt: 15 lbs.

Order #	Item #	Catalog Price
021-0060	MS1206	\$352.00

Small Depository B-Rate Under the Counter Units

For convenient deposits of cash or checks at register locations and route trucks. Units mount easily for under the counter applications. Standard: 3.5" x 3.5" door opening. 2X: 7.5 x 5.25" door opening.

-2 Dual key operation

All Safes F.O.B. Our Warehouse

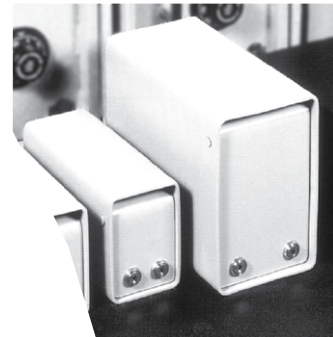
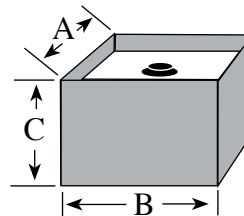

Order #	Item #	Inside Dimensions			Outside Dimensions			Cu. Inch	Approx Weight	List Price
		A	B	C	A	B	C			
021-0310	JO-626-2	5 ⁵ / ₈	3 ⁵ / ₈	8	6	4	10	164	13	\$132.00
021-0315	JO-626-2X	9 ⁵ / ₈	5 ⁵ / ₈	10	10	6	12	541	26	170.50

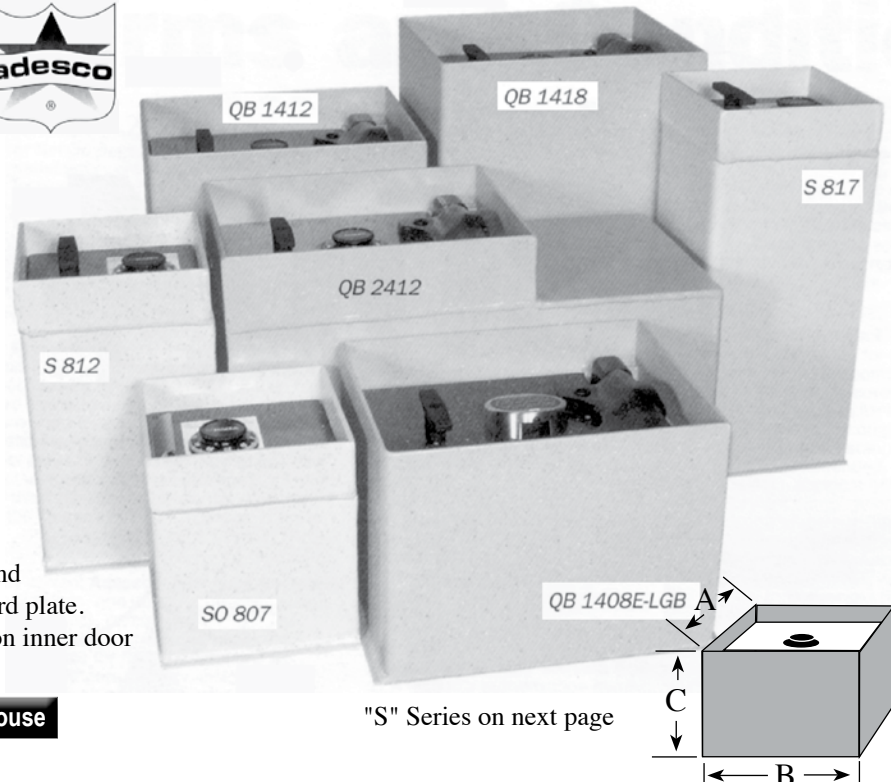

Standard Features

- 1/2" thick high tensile steel door
- Two built-in relocking devices
- Locking mechanism secured with a U.L. approved combination lock, and is protected with a drill resistant hard plate.
- D/DP models have single key lock on inner door

All Safes F.O.B. Our Warehouse

"S" Series on next page

Order #	Item #	Inside Dimensions			Outside Dimensions			Cu. Inch	Approx Weight	Price
		A	B	C	A	B	C			
021-0005	QB 1408	12	14 ¹ / ₂	8	12 ³ / ₈	14 ⁷ / ₈	11 ¹ / ₄	1392	87	\$621.50
021-0010	QB 1412	12	14 ¹ / ₂	12	12 ³ / ₈	14 ⁷ / ₈	15 ¹ / ₄	2088	102	676.50
021-0015	QB 1418	12	14 ¹ / ₂	18	12 ³ / ₈	14 ⁷ / ₈	21 ¹ / ₄	3132	120	775.50
021-0025	(U) QB 2412	12	24	12	12 ³ / ₈	24 ³ / ₈	15 ³ / ₄	3456	122	875.00
021-0030	(U) QB 2424	24	24	12	24 ³ / ₈	24 ³ / ₈	16 ¹ / ₄	6912	215	1724.80

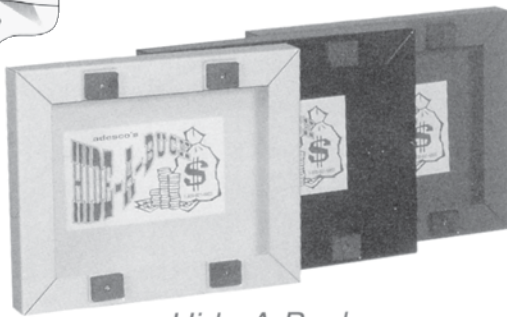

Hide-A-Buck

Hide-A-Buck

- Solid steel construction
- 4 ceramic magnets
- Holds up to three 1" thick bundles of cash
- Available in gray, black, or tan

Inside dimensions: 7" x 8-3/4" x 1"

Exterior dimensions: 7-1/8" x 8-7/8" x 1-1/8"

Weight: 1 lb.

Order #	Item	Finish	Catalog Price
021-0505	Hide-A-Buck	Black	\$32.46
021-0510	Hide-A-Buck	Tan	32.46
021-0515	Hide-A-Buck	Grey	32.46

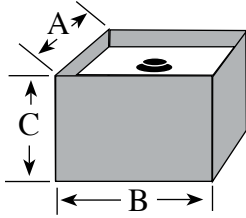

Economy Stealguard Original B Rate Liftout Door Floor Safe



Low priced formidable bandit barrier. **Flush-handle liftout door**. Clear Door Opening: $6\frac{3}{4} \times 7\frac{3}{4}$
812S & 817S: With Slotted Door.



SO 807, SO 812 & S 817

Order #	Item #	Inside Dimensions			Outside Dimensions			Cu. Inch	Approx Weight	Price
		A	B	C	A	B	C			
021-0085	(U) SO 817S	$8\frac{3}{8}$	$8\frac{3}{8}$	17	$8\frac{3}{4}$	$8\frac{3}{4}$	$20\frac{1}{4}$	1192	70	609.40

(U) Available while supplies last.

Freight is Extra on all Safes

Economy, Stealguard Original B Rate Liftout Door Floor Safe

Quality security at an affordable price. **T-handle liftout door**. Clear Door Opening: $6\frac{3}{4} \times 7\frac{3}{4}$

812S & 817S:
With Slotted Door.

Order #	Item #	Inside Dimensions			Outside Dimensions			Cu. Inch	Approx Weight	Price
		A	B	C	A	B	C			
021-0100	(U) S 812	$8\frac{3}{8}$	$8\frac{3}{8}$	12	$8\frac{3}{4}$	$8\frac{3}{4}$	$15\frac{1}{4}$	842	60	506.00
021-0110	(U) S 812S	$8\frac{3}{8}$	$8\frac{3}{8}$	12	$8\frac{3}{4}$	$8\frac{3}{4}$	$15\frac{1}{4}$	842	60	609.40
021-0115	(U) S 817S	$8\frac{3}{8}$	$8\frac{3}{8}$	17	$8\frac{3}{4}$	$8\frac{3}{4}$	$20\frac{1}{4}$	1192	71	658.90

Rotary & Front Deposit, B Rate Units

Doors are easily removed and inter-changed with dual control keylocks, utilizing the Adesco interchangeable quick release hinge assembly.

Mar resistant textured finish.

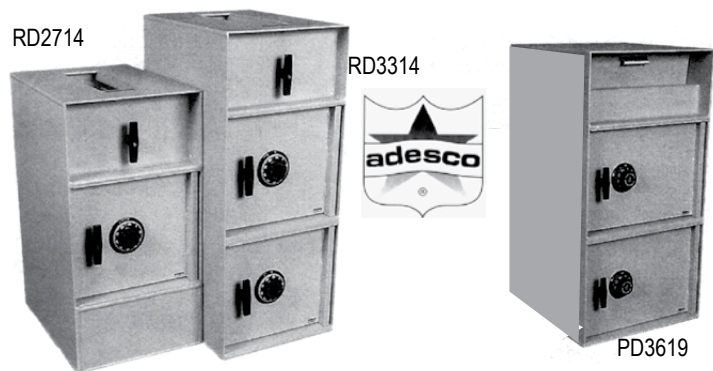

Standard Features

- RD units drop through the top and easily accommodate bank bags and large envelopes.
- PD "Postal Drop" Units have 4" x 11" x 8" receiving area.
- High strength locking bars secure against prying & drilling.
- Special relocking devices activate during an attack.
- UL Listed Group 2 combination lock.
- 5" solid steel cam activated locking bar
- Two spring loaded relocking devices
- Solid hand welded door and body for maximum security
- Drill resistant carburized lock mount plate
- 4 pre-drilled mounting holes
- Solid formed steel body
- Hinged door • Powder-coated enamel finish

All Safes F.O.B. Our Warehouse

Economy Deposit Added Features

- Compact Design
- Three Solid Steel Locking Bolts
- PD Package Size: 2³/₄ x 8 x 11
- RD Package Size: 3¹/₄ x 9 x 6

Order #	Item #	Inside Dimensions			Outside Dimensions			Cu. Inch	Approx Wt.	Price
		H	W	D	H	W	D			
021-0135 (U)	RD 3619*	13 ¹ / ₂	18 ¹ / ₂	16 ¹ / ₂	36	19	19	4121	303	\$2156.00
021-0600	RD 2014	13	13 ³ / ₄	11	20	14	14	1966	89	\$1402.50
021-0605	RD 2614	19	13 ³ / ₄	11	26	14	14	2874	115	1545.50
021-0610	RD 3214*	13	13 ³ / ₄	11	33	14	14	1966*	161	2150.50
021-0615	PD 2014	13	13 ³ / ₄	11	20	14	14	3118	89	797.50
021-0620	PD 2614	19	13 ³ / ₄	11	26	14	14	3187	115	1611.50
021-0625	PD 3214*	13	13 ³ / ₄	11	33	14	14	4121*	161	2222.00

(U) Available while supplies last.

H= Height
W= Width
D= Depth

* Both compartments have the same dimensions.

1 Hour Fire Safes

B-Rated units are excellent for home and small business use.

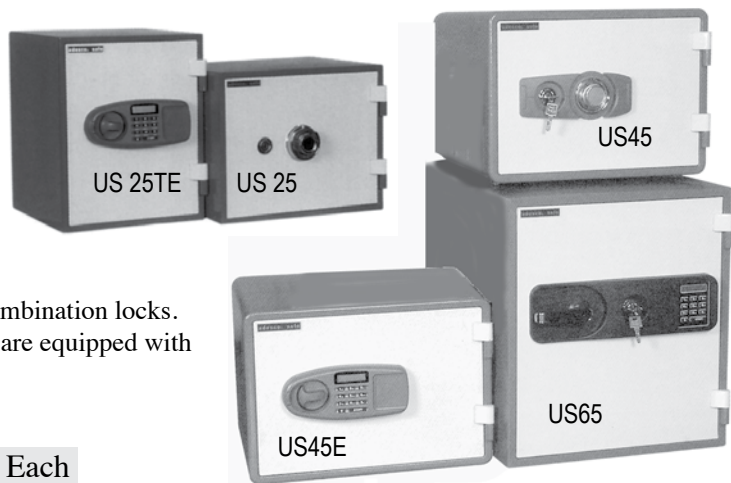

Standard Features

- Combination dial and key locks for dual security and/or day lock function.
- US35E & US45E have digital/electronic locks.
- All 2 hour firesafes equipped with key changeable combination locks.
- 1 hour units have non-skid rubber feet. 2 hour units are equipped with cast wheel for mobility.

Adesco Key Blank for Fireguard Safes

021-1000	#11336	\$3.70 Each
----------	--------	-------------

Order #	Item #	Inside Dimensions			Outside Dimensions			Interior Features		Approx Weight	Catalog Price
		H	W	D	H	W	D	Shelves	Trays		
021-0174	US 25	6	12	8 1/2	11 3/4	15 1/4	12 1/2	1		55	\$397.00
021-0176	US 25E	6	12	8 1/2	11 3/4	15 1/4	12 1/2	1		55	396.00
021-0177	US 25T	9 1/2	8 1/2	8 1/2	15 1/2	11 1/2	12 1/2	1		55	297.00
021-0178	US 25TE	9 1/2	8 1/2	8 1/2	15 1/2	11 1/2	12 1/2	1		55	396.00
021-0195	US 45	6 3/4	13 3/4	10 1/4	13 1/2	18 3/4	15 1/2	0	1	90	379.50
021-0205	US 45E	6 3/4	13 3/4	10 1/4	13 1/2	18 3/4	15 1/2	0	1	90	511.50
021-0210	US 65	14 3/4	13	12 1/4	20 3/4	16	19	0	1	120	537.50
021-0375	US65E	14 3/4	13	12 1/4	20 3/4	16	19	0	1	120	638.00

NEW LARGER MODEL - CBF-3A

Large enough for the needs of the most demanding household yet small enough to get into a closet.



Offers a large interior capacity, lower retail price and four times the fire protection of any other burglar and fire safe on the same size on the market today.

Features

- 2" thick composite door
- 3" thick composite body
- Center bolt down hole
- 2 Hour Fire Label
- Tri-Spoke Handle • Two adjustable shelves
- Massive two toned hinges • Tempered glass reload trigger
- Three massive 1-1/4" locking bolts
- Lifetime manufacturers replacement guarantee
- Smoke gray body color matched to Krylon Smoke Gray
- Ivory door color matched to Krylon Ivory

All Safes F.O.B. Our Warehouse

	<i>High</i>	<i>Wide</i>	<i>Deep</i>
Inside Dimensions:	35	16	16
Outside Dimensions:	41.5	22.75	24
Weight: 595 lbs.	FOB Our Warehouse		
Order #	Item #	Catalog Price	
021-0440	CBF-3A	\$ 2145.00	

2 Hour Rated Fire Safes , B-Rated

Safes are excellent for home and small business use.

- 2-Hour KIS fire rating
- UL Listed Group 2 combination lock and high security key lock for dual security and/or day lock function
- Equipped with adjustable shelves and locking drawers
- Equipped with cast wheels for mobility



Order #	Item #	Inside Dimensions			Outside Dimensions			Interior Features			Approx Weight	Price
		H	W	D	H	W	D	Shelves	Trays	Drawers		
021-0250	US 360 (U)	37 ¹ / ₄	21	18	53 ³ / ₄	29 ¹ / ₄	25	3	0	1	640	2697.20*
021-0265	US 650 (U)	53 ¹ / ₄	39 ¹ / ₂	19 ³ / ₄	70	47 ³ / ₄	26 ¹ / ₄	3	0	2	1254	6283.20*

All Safes F.O.B. Our Warehouse

BURGLAR & FIRE PROTECTION

ADESCO offers 2 hour fire rated safes with the best of burglar protection features, and composite fire resistant safes.

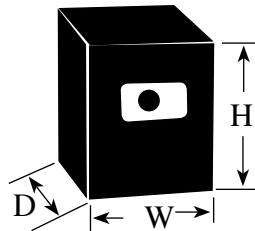

Standard Features

- Group 2 combination lock
- Two independent relockers
- Composite door and body construction
- Handle activated lock work
- Fire resistant



2-Hour Rated. TL-15 "Style" Lockwork

- Tri-Spoke Handle
- 2" Thick Door
- 3" Thick body
- Glass Relock Trigger

Order #	Item #	Inside Dimensions			Outside Dimensions			Cu. Inch	Approx Weight	Interior Shelves	Clear Door Opening	Price
		H	W	D	H	W	D					
021-0400	CBF-1	12	11 ¹ / ₂	12	17 ³ / ₄	17 ³ / ₄	20 ¹ / ₂	1656	210	1	12 x 12	1106.50
021-0410	CBF-2	21	13 ¹ / ₂	13	27	20	20 ¹ / ₂	3685	325	1	21 x 14	1463.00
021-0420	CBF-3	27 ¹ / ₄	13 ¹ / ₂	15	33	20	22 ³ / ₄	5518	390	2	27 x 14	1639.00
021-0425	CBF-4	27	21 ¹ / ₂	21	33 ¹ / ₄	28	29	12191	575	2	27 x 22	2216.50
021-0430	CBF-5	35 ¹ / ₂	22	20	41 ¹ / ₂	28	29	15620	685	2	35 x 22	2568.50
021-0435	CBF-6	54	23	21 ¹ / ₄	59 ¹ / ₄	28	29	26393	830	2	54 x 23	3635.50

**BUDDY
WALL SAFES**



Mounts Between Wall Studs.

Double-reinforced heavy gauge steel door with recessed deadbolt combination lock for flush-to-the-wall mounting and easier concealment. Nearly 500 cubic inches of storage space.

12-1/4" x 6" high opening.

16-3/8" wide x 11" high face plate.

Order #	Item	PRICE
156-3100	BUD-3100	\$201.54

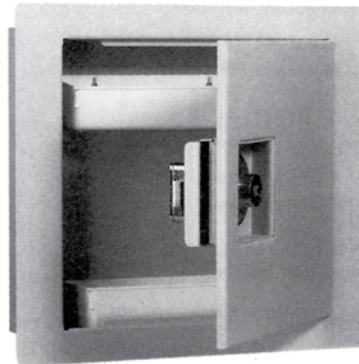

HPC
WS200

Constructed of heavy gauge steel, with all exposed parts are dual reinforced steel.

- **Door & Face (Lip):** 12 gauge reinforced with 14 gauge.
- **Interior Box:** 14 gauge
- **Lock Area:** 12 gauge reinforced with 14 gauge layered with drill-deflecting compound
- **True Flush:** Hinge and lock are below surface
- **Texture Painting:** Unique two-step texture epoxy painting process, then oven baked dry.



WS100

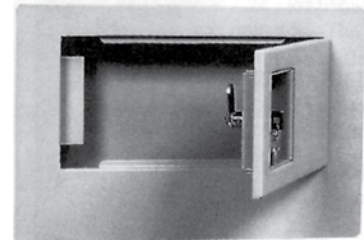

**Small
Wall Safes**

475 Cubic Inches Inside. 3.75" deep.

Door Opening: 11-1/2" x 5-1/2"

Order #	Item #	Lock Type	Price
360-2340	WS-100	Standard	\$170.50
360-2345	WS-100C	Combination	277.70

Large Wall Safe

670 Cubic Inches Inside.

Door Opening: 11-1/2" x 11-1/2"

Order #	Item #	Lock Type	Price
360-2350	WS-200	Standard	\$263.00
360-2355	WS-200C	Combination	327.00

NEW SAFES

FireKing 
The best records protection you can buy.

NEW

Available now, contact your sales rep for pricing and delivery information

FIREPROOF INSULATION
is 100% gypsum, reinforced by a 1" by 2" lattice made of 14-gauge galvanized welded steel wire, providing complete peace of mind from fire, impact, or explosion.

FIELD REPLACEABLE STEEL PANELS
can easily be replaced in the event that any panel is damaged.

FINISH
is an environmentally-friendly electrostatic powder coating applied to all sides, including bottom. The finish is scratch-resistant, providing a lifetime quality appearance.

DRAWER BODIES
are built with high sides for use with hanging folders – no additional frames are needed.

DRAWER SUSPENSIONS
are maintenance free and are guaranteed for life.

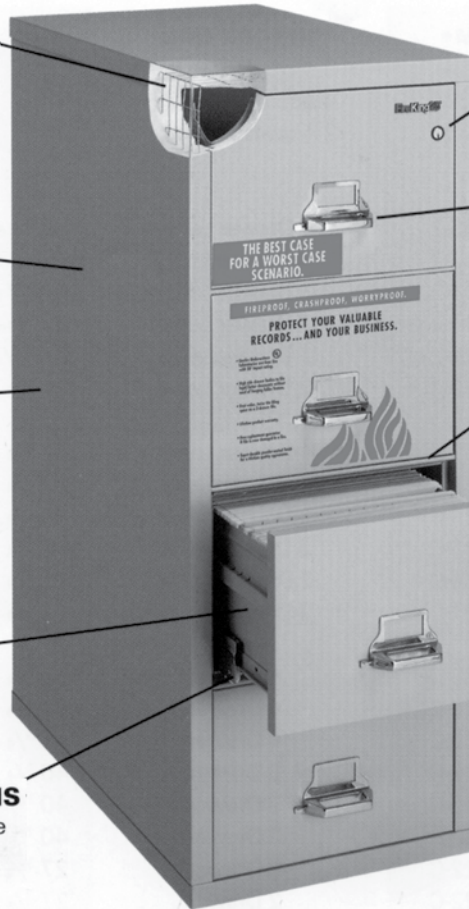

DRAWER LOCKS
on all files provide general locking of all drawers through either standard key locks or UL®-listed high-security locks.

DRAWER PULLS
are surface mounted to allow for extra insulation inside the drawer heads.

INSULATION BETWEEN ALL DRAWERS
makes each drawer a separate insulated container.

2-POSITION DRAWER CATCH
allows access to certain drawers while others remain locked.

DRAWER HEADS
are formed of welded steel and filled with fireproof insulation, and are field replaceable.

UNDERWRITERS LABORATORIES® (UL®) FIRE & IMPACT RATING
on all file cabinets.
See back for details.



STORAGE CABINET
72" high – 4 shelves
44" high – 2 shelves



VERTICAL
25" or 31" Depth
Choose Legal or Letter
2, 3, or 4 Drawers



LATERAL
31", 38" or 44" Widths
2, 3, or 4 Drawers



TURTLE®
22" Depth
Letter/Legal Filing
2 or 4 Drawers



MEDIAVAULT™
Protection for
Data/Computer
Media



Fire, Tornado, or Explosion can destroy your building. But they don't have to destroy your business.

ITEM#	DESCRIPTION	H"	W"	D"	SHIP WT.
CF7236-F	4 Adjustable Shelves	72	36	19 1/4	892 lbs.
CF4436-F	2 Adjustable Shelves	44	36	19 1/4	620 lbs.
4-1831-C	4 Drawer Letter	52 3/4	17 11/16	31 9/16	603 lbs.
4-2131-C	4 Drawer Legal	52 3/4	20 3/4	31 9/16	664 lbs.
3-1831-C	3 Drawer Letter	40 1/4	17 11/16	31 9/16	479 lbs.
3-2131-C	3 Drawer Legal	40 1/4	20 3/4	31 9/16	526 lbs.
2-1831-C	2 Drawer Letter	27 3/4	17 11/16	31 9/16	348 lbs.
2-2131-C	2 Drawer Legal	27 3/4	20 3/4	31 9/16	383 lbs.
4-3122-C	4 Drawer	52 3/4	31 1/8	22 1/8	794 lbs.
4-3822-C	4 Drawer	52 3/4	37 27/64	22 1/8	907 lbs.
4-4422-C	4 Drawer	52 3/4	44 27/64	22 1/8	1,019 lbs.
3-3122-C	3 Drawer	40 1/4	31 1/8	22 1/8	574 lbs.
3-3822-C	3 Drawer	40 1/4	37 27/64	22 1/8	756 lbs.
3-4422-C	3 Drawer	40 1/4	44 27/64	22 1/8	791 lbs.
2-3122-C	2 Drawer	27 3/4	31 1/8	22 1/8	456 lbs.
2-3822-C	2 Drawer	27 3/4	37 27/64	22 1/8	532 lbs.
2-4422-C	2 Drawer	27 3/4	44 27/64	22 1/8	584 lbs.
4-1825-C	4 Drawer Letter	52 3/4	17 11/16	25	508 lbs.
4-2125-C	4 Drawer Legal	52 3/4	20 3/4	25	551 lbs.
2-1825-C	2 Drawer Letter	27 3/4	17 11/16	25	287 lbs.
2-2125-C	2 Drawer Legal	27 3/4	20 3/4	25	326 lbs.
4R1822-C	4 Drawer	52 3/4	17 11/16	22 1/8	435 lbs.
2R1822-C	2 Drawer	27 3/4	17 11/16	22 1/8	251 lbs.
MV1000	Data Chest	10 1/2	11 5/8	17 1/2	74 lbs.
DS1513-1LG	1-Hour Fire/Impact Rating	25 1/2	21 1/2	22 2/5	297 lbs.
DS1817-1LG	1-Hour Fire/Impact Rating	28 3/5	25 1/2	26 3/5	429 lbs.
DS2320-2	2-Hour Fire/Impact Rating	36 1/8	29 7/16	30	680 lbs.
DS3420-2	2-Hour Fire/Impact Rating	47 3/16	29 7/16	30	880 lbs.
DS4520-2	2-Hour Fire/Impact Rating	58 1/4	29 7/16	30	1,070 lbs.
DS6420-2	2-Hour Fire/Impact Rating	76 13/16	40 7/8	30	1,380 lbs.
DS6431-2	2-Hour Fire/Impact Rating	76 13/16	40 7/8	32 3/16	1,870 lbs.
DM1413-3	3-Hour Fire/Impact Rating	29 5/8	25 1/4	31	650 lbs.
DM2513-3	3-Hour Fire/Impact Rating	40 1/4	25 1/4	31	740 lbs.
DM2520-3	3-Hour Fire/Impact Rating	40 1/4	32 1/16	31	1,050 lbs.
DM3420-3	3-Hour Fire/Impact Rating	49 1/16	32 1/16	31	1,240 lbs.
DM4420-3	3-Hour Fire/Impact Rating	59 3/4	32 1/16	31	1,420 lbs.
DC2123	1-Hour Fire Rating	21	22 3/8	21 3/8	275 lbs.
DC2923	1-Hour Fire Rating	28 7/8	22 3/8	24 1/2	405 lbs.
DC3523	1-Hour Fire Rating	34 7/8	22 3/8	24 1/2	495 lbs.
DC2931	1-Hour Fire Rating	28 7/8	30 7/8	27 1/8	575 lbs.
DC3531	1-Hour Fire Rating	34 7/8	30 7/8	28 1/8	640 lbs.

All Safes F.O.B. Our Warehouse



PERMA•VAULT Safe Corporation

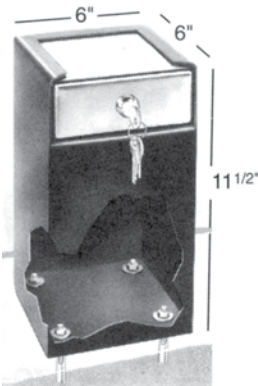

PV-100

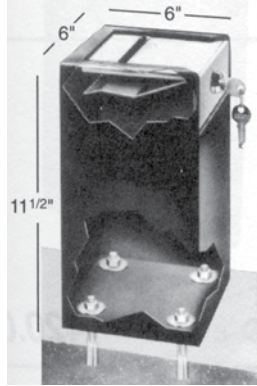

PRO-30AF

**COMMERCIAL, INSTITUTIONAL
SAFE DEPOSIT BOX.**

UL approved MEDECO security lock with 2 keys. Black, stippled baked enamel finish. **\$247.00**

Order #	Item #	Dimensions
150-0100	BFP-PV-100	6" x 6" x 11.5"

CASH PROTECTION SYSTEM

UL approved MEDECO security lock with two (2) keys. Slotted top to receive cash and checks. "Anti-fish" baffle included. Black, stippled baked enamel finish.

\$264.00

150-0038	BFP-PRO-30AF	6" x 6" x 11.5"
----------	--------------	-----------------

Two UL approved MEDECO security locks with 2 keys per lock. Slotted top to receive cash and checks. "anti-fish" baffle included. Black, stippled, baked enamel finish.

\$349.50

150-0040	(U) BFP-PRO-40AF	6" x 6" x 11.5"
----------	------------------	-----------------

**Permavault with
Medeco Lock**

UL approved Medeco security lock with two keys. Slotted Top to receive cash and checks. "Anti-fish" baffle included. Black stippled, baked enamel finish. 10 x 8 x 11.5. Wt. 18 lbs.

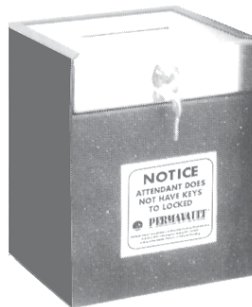

150-0070	PRO-70	\$378.76
----------	--------	-----------------

In-Wall Safes

U.L. approved MEDECO lock with two keys. Stippled, baked enamel finish. Door has welded hidden hinge for added security. Adjustable shelf for user's convenience. Fits between standard wall studs.



• Outside: 15.75" x 15.75"; Inside: 14.25" x 14.25" x 3.5".

150-0110	BFP-WS-100	\$286.00
----------	------------	-----------------

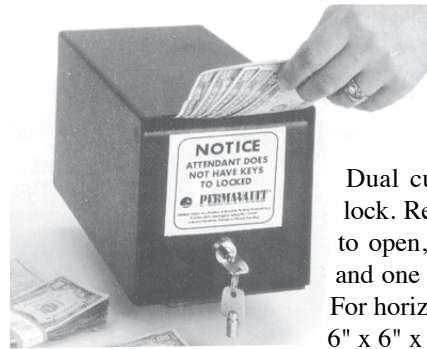

**Cash
Protection
System**

Dual custody safe deposit lock. Requires two (2) keys to open. Two operator keys and one guard key included. For horizontal installation. 6" x 6" x 11.5". Wt. 11 lbs.

Order #	Item #	Price:
150-0021	PRO-20KK	\$190.00

Security Tubular Lock with (2) two keys. To receive cash and checks. "Anti-fish" baffle included, black stippled, baked enamel finish. For Horizontal Installation.

6 x 6 x 11.5. Wt. 11 lbs.

150-0020	PRO-20	\$149.26
----------	--------	-----------------

All Safes F.O.B. Our Warehouse



**Permavault,
Dual Custody**

Safe deposit lock. Sliding Drawer to receive cash or checks. Black stippled, baked enamel finish. 6 x 12 x 12, Wt. 21 lbs.

Price: \$292.50

150-1050	PRO-1050-SD
----------	-------------

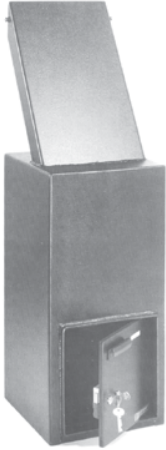

PERMA•VAULT Safe Corporation

All Safes F.O.B. Our Warehouse

**PermaVault
Depository Safe**

with Adjustable Chute for "Through the Wall" installation, or free standing, using double custody safe deposit lock. Requires two keys to open, two operator keys supplied. 12 x 12 x 25. Wt. 100 lbs.

150-2225	2225-CH-K
	\$1085.00

**ROTARY
HOPPER SAFES**

"K" Rotary Hopper Safes With Ilco double custody safe deposit lock.

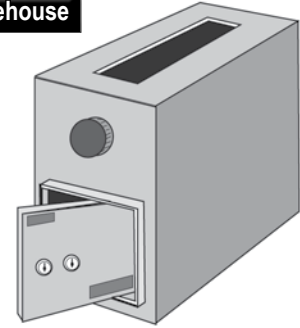

Order #	Item #	Dimensions
150-0814	PV814-K	8" x 11-3/4" x 13" \$502.00
150-1217	PV1217-K	12" x 12" x 17" \$640.00

**PermaVault
w/Medeco Lock**

For Installation through the top of Counter. UL approved MEDECO security lock with two keys. Black stippled, baked enamel finish. 6 x 6 x 12, Wt. 14 lbs.

150-1206	PRO206M
Catalog Price: \$321.50	



**Rotary Depository
Hopper Safe**

Group 2 UL Combination Lock. Combination can be changed to your private numbers. 12 x 12 x 17. Wt. 65 lbs.

150-1218	PV-1217-C
Catalog Price: \$752.00	



**Through the
Door/Wall
Depository**

- Heavy gauge steel construction
- Anti-fish baffle deters removal of contents
- Chute is designed as part of the safe and cannot be removed; measures 5-1/2" x 1"
- Chute opening for easy insertion of cash, checks, or keys without opening
- Pre-drilled anchor bolt holes permits bolting and mounting to any structurally sound surface



Limiting exposed deposits helps prevent:

- External Loss
- Internal Loss
- Deposit Variance
- Register Stripping

PERMA•VAULT BFP 903-M

- Perma-Vault can be placed in a convenient location wherever cash, checks, or receipts are handled.
- UL Listed Medeco Locking System
- Keys removable only in locked position.
- "Anti-fish" baffle makes an affordable, safe, and convenient depository for interim storage of cash and checks.
- SAFE SIZE: 10" Wide; 8" Deep; 14.5" High

Order #	Item #	Catalog Price
150-0903	BFP 903-M	\$454.26

**Optional Extension Chute for Installation
Through Interior Wall Stud**



Order #	Item #	Outside Dimensions	Catalog Price
150-9031	CH-9031	5-3/4" x 5-7/16"	\$69.26

**Optional Extension Chute for Installation
Through Exterior Wall**



150-9032	CH-9032	10" x 5-7/16"	\$81.48
----------	---------	---------------	----------------

PRO-LOK™

Electronic Safes



This safe passed the following tests:
**PICKING, TENSILE, PLUG TORQUE,
 MANIPULATION, SHOCK, SAWING,
 FORCED REMOVAL, PLUG PULLING, DROPPING.**

AFFORDABLE ENTRY LEVEL SAFES
 Home, Office, RV, Auto, Boat, Closet, Dorm
Pro-Lok Electronic Safe

Easy to program and change the combination in seconds.

- Solid steel construction for extra security
- Electronic security lock
- Manual override key function
- Two bolts supplied to anchor safe down
- Two steel locking bolts for added security
- Removable shelf inside • Compact size
- 4 AA batteries included to operate keypad.

“These are California-approved firearms safety devices that meet the requirements of California Penal Code Section 12088 and the regulations issued thereunder.”

Order #	Item # / External Dimensions	Catalog Price
684-0008	PRO GLSF-8 w=13.75 x d=10" x h=10"	\$174.00
684-0010	PRO GLSF-10 w=15" x d=12" x h=12"	330.40

PRO-LOK™

Lap Top Electronic Safe



External Size

W= 17-1/4"
 D= 17-1/4"
 H=9-3/4"

Internal Size:

W= 17"
 D=16-3/4"
 H=9-1/2"
 Weighs 44 pounds

The GLSF-15 Laptop Safe

is ideal for dorms as well as anyone who needs a wider safe door to fit most laptop computers inside (or whatever else you need to secure).

- 2 chrome 3/4" bolts for extra security
- Program & change your own combination in seconds.
- Manual override key function.
- Solid Steel construction
- 4 bolts provided to anchor the safe
- 4AA batteries included to operate keypad

Order #	Item #	Catalog Price
684-0015	GLSF-15	\$248.40

PRO-LOK® FIRE SAFES



Economical Fire Resistant Chests

- Offers 30 minutes of fire resistance.
 - Tubular key and lock for added security.
 - Holds 8-1/2 x 11" size documents
 - Convenient handle
 - Textured finish • Colorful retail packaging
- External Dimensions: 15-1/4"W x 12-1/2"D x 6-1/2"H
 Internal Dimensions: 13"W x 8-1/2"D x 4"H

Order #	Item #	Catalog Price
684-0018	GLSF-FC15	\$102.00

Fire Resistant Safe

- Offers 30 minutes of fire resistance
- Easy user changeable 3-8 digit codes
- Removable interior shelf
- Emergency manual key override
- Double chrome plated locking bolts
- Durable epoxy powder coated finish
- Solid steel construction for extra protection
- LED light indicators sounding security and battery status
- Buzzer feedback for each operation
- 4 - replaceable AA batteries included
- Pre-drilled mounting holes
- Colorful retail packaging that will create impulse sales.



Fire Resistant Safes

Exterior Dimensions: 18"W x 16"D x 12-1/4"H
 Interior Dimensions: 14"W x 11"D x 9"H

Order #	Item #	Catalog Price
684-0017	GLSF-FR31	\$402.00

PRO-LOK®



Slotted Electronic Safes

When the door is locked, deposits can be made via a deposit slot. Sometimes referred to as "trim safes" they are designed to reduce the risk of robbery by limiting the amount of money in the cash register. These safes are not meant for unprotected overnight storage of cash or valuables. Depository safes are recommended for any operation that requires a non-returnable deposit such as armored car companies, convenience stores, restaurants, gas stations and other businesses. This safe is designed for small businesses or vehicles which need to store cash or receipts until the daily bank deposit.

- Weight: 35 pounds.
- Storage capacity: 1150 cubic inches
- Easy to program & change your own combination in seconds.
- Electronic security lock.
- Solid steel construction
- Manual override key function.
- 4 bolts provided to anchor the safe down.
- 2 steel locking bolts for added security
- 4 AA Batteries included to operate keypad.
- External Dimensions: 13-2/3" W x 10" D x 10" H
- Internal Dimensions: 13-1/2" W x 9-1/2" D x 3-3/4" H

Order #	Item #	Catalog Price
684-0009	GLSF-08S	\$204.00



GLSF-08FP - Small Fingerprint Safes

Affordable Fingerprint Safes are here!

Need added security without the inconvenience of memorizing a combination? The GLSF-08FP safe utilizes affordable fingerprint recognition technology to do just that.

The GLSF-08FP, Fingerprint Safe (commonly referred to as a biometric safe), stores up to 29 fingerprints and is ideal for securing valuables in the home, dormitory, hospital, boat, RV, or office with a simple touch.

The safe is made from solid steel for added security, has 2 chrome bolts of 3/4" of an inch diameter for extra security, and has a manual override key. Includes 4 bolts to anchor the safe and a removable interior shelf.

Packaged in colorful retail packaging.

External size W=13-3/4", D=10", H=10"
Internal size W=13-1/2", D= 9 1/2", H= 8 3/4"

Order #	Item #	Catalog Price
684-1008	GLSFO8-FP	\$462.00

GLSF-10FPM - Large Fingerprint Safe

DOOR OPENS AUTOMATICALLY!

Need added security without the inconvenience of memorizing a combination? The GLSF-10FPM safe utilizes affordable fingerprint recognition technology to do just that.

The GLSF-10FPM, Fingerprint Safe (commonly referred to as a biometric safe), stores up to 30 fingerprints and is ideal for securing valuables in the home, dormitory, hospital, boat, RV, or office with a simple touch. Once the fingerprint is recognized, the door opens automatically. When you want the safe locked, just push the door shut. There is no wondering if the safe door is in the locked or unlocked position.

The safe is made from solid steel for added security, has 2 chrome bolts of 3/4" of an inch diameter for extra security, and has a manual override key. Includes 4 bolts to anchor the safe and a removable interior shelf

Packaged in colorful retail packaging.

External size W=15", D=12", H=12"
Internal size W= 14-3/4", D= 11-1/2", H= 10-3/4"

Order #	Item #	Catalog Price
684-1010	GLSF10-FPM	\$582.00

Sargent & Greenleaf

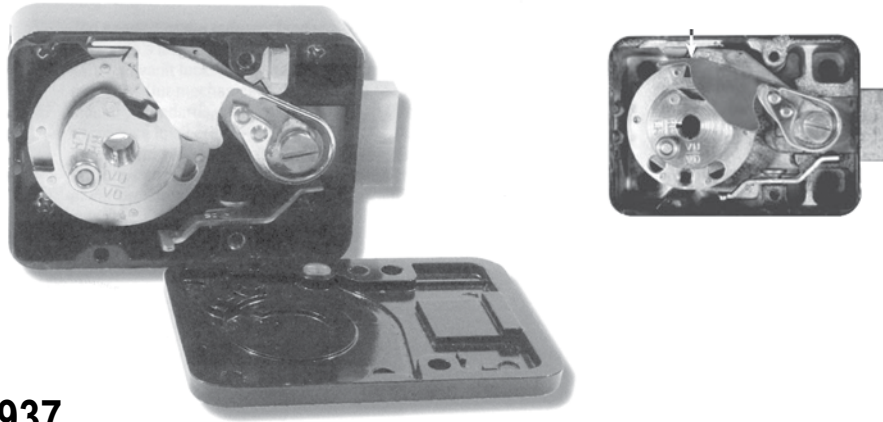

S&G Model 2937 Mechanical Safe Locks Meets United States Federal Specification FF-L-2937

Sargent and Greenleaf safe locks have been protecting the assets of banks, businesses and governments for almost 150 years. The S&G 2937 lock represents the latest design advances to produce a mechanical lock to secure certain types of GSA approved containers, such as field safes, armory vault doors, weapons containers, and similar items.

Based on the 8550 platform, but with significant modifications necessary to meet the FF-L-2937 specification. Two modifications are the 2937's stainless steel bolt and a spindle, which has two carbide pins. In addition, the end of the bolt has two drilled/tapped holes for bolt work attachment, required by the specification.

The FF-L-2937 must be used on the following GSA approved products:

- Weapon Container - specification number AA-C-2859.
- Weapon Vault Door - specification number AA-D-600D (Class 5A, design S).
- Field Safe - specification number AA-F-358H (Class 6, Size VIII).

Product Features

- The only lock approved to meet Federal Specification FF-L-2937.
- Based on the time tested S&G 8550 platform.
- Three all-metal wheel construction.
- Special spindle containing two carbide pins for added punch & drill protection.
- Spy-Proof Dial.
- Familiar left-right-left dialing sequence
- Twenty man-hours of resistance to expert manipulation.
- Built in thermal protection provided in integral thermal relock component.
- UL Group 1; Federal Specification FF-L-2937
- Key changeable wheel design for simple combination changing.
- Stainless steel bolt meets specification to resist 600lbs. force.
- Bolt end contains two drilled/tapped holes to meet the federal specification.
- S&G's patented torque adjuster allows precise setting and maintenance of wheel pack torque.
- Uses the S&G "Magic Module" footprint for easy retrofit.

Order #	Item #	Catalog Price
735-2937	S&G 2937	\$683.66

Sargent & Greenleaf

Key Changing R Series. 3-Wheel, Relock.

UL Group 2 Rated. Suitable for use on insulated safes, record containers, strong boxes and light vault doors. Combination can be changed by the use of a special key while dialing the new combination to a special changing index on the dial. Non-tube 3-wheel, offers up to one million different combinations. Supplied with a 4-way drive cam which allows for mounting in right or left hand, vertical-up or down positions. Relocking trigger automatically deadlocks the bolt if entry is attempted by punching the spindle or lock case. Dimensions: 3.25" wide x 2.30" high x 1" deep. Weight: 1 lb. 1 oz. D300 Dial & R211 Ring.

735-2008	SRG R6730	\$179.12
----------	-----------	----------

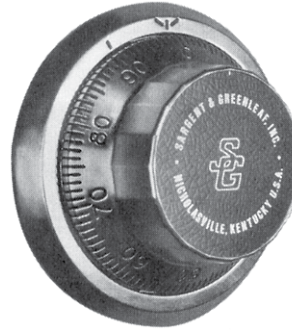

R6730

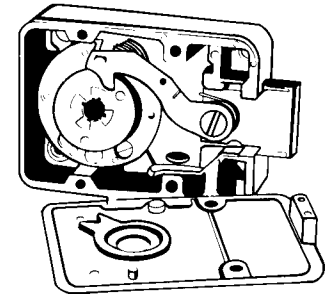

Kit for Tube Lock Applications

on S & G Safe Locks.

735-3024	(U) SRG-U24	\$14.24
----------	-------------	---------

8550 MP Manipulation-Proof

UL Group 1 & 1R. Offers true high security along with simplicity and ease of operation. Equipped with a special relock trigger which automatically secures the lock if the spindle is punched. A thermal relock device also protects against entry by the application of heat. Utilizes S&G's Spyproof dial and ring (D54 & DR162). Torque Adjustment makes it possible to adjust dialing torque to individual touch with the use of an allen wrench. This feature also adds additional security by enabling precise torque pressure to be applied to the wheelpack. Three brass wheels offer one million combination changes. Constructed of rugged die cast Zamak and meets US Government specs.(MIL-L-15596-E, Type I and II). Dimensions: 3.25" wide x 2.30" high x 1.10" deep. Weight: 1 lb. 2.5oz. D054 Dial & R162 Ring.

735-2006	8550-100	\$404.28
----------	----------	----------



8550 Series

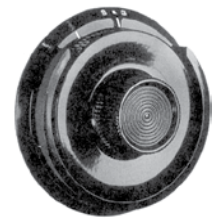

Accelerator Spring in Released Position

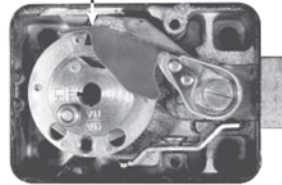

Accelerator Spring in Loaded Position

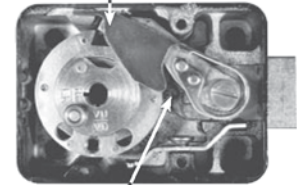

Torque Adjusting Gear

SRG-6804

Key Operated Lock

This key lock matches the installation of 6700, 8400 & 8500 series. It is a blend of security and convenience. For inner compartmental and outer safe doors, furniture, filing and office equipment. Changeable using a standard allen or hex wrench. Seven levers with false gates provide pick resistance equal to locks used in safe depositories. The lever stack forms an internal shroud around the key so that the lock is difficult, often impossible to "read" with all modern optical burglary tools.

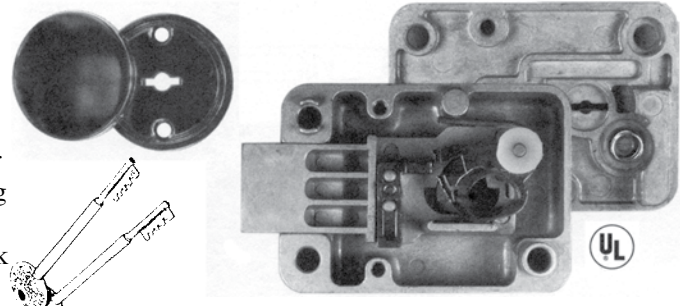

Single Bit, w/ 2 keys. Key Retaining.

Dimensions: 3 11/32" x 2 13/32" x 1 7/64"

735-6804	SRG-6804	\$143.52
----------	----------	----------

Sargent & Greenleaf

Electronic Combination Lock Model 6120

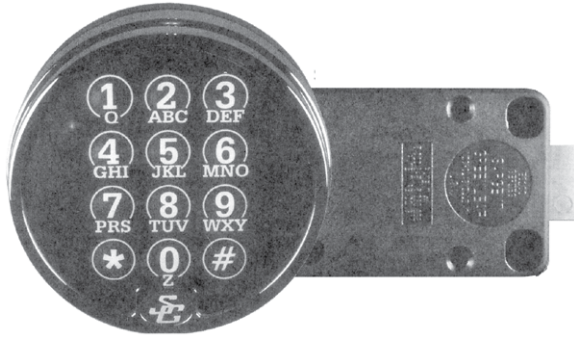

The market for upgrading or retrofitting existing safes with electronic locks is virtually untapped. From the customer's perspective, electronic locks offer several distinct advantages over mechanical safe locks. S & G's 6120 offers a secure, dependable, easy to use lock that looks as good as it works.

Ease of Operation. Its like dialing a touch tone phone.

Fast Opening. Elimination of fourturnsleft, three turns right, etc.

Easy Combination Changing. All operations are easily carried out from the keypad with no tools required..

More Security. Even a very good three-wheel lock only offers about 150,000 distinct combinations. The 6120 offers a true one million.

LOCK BODY ONLY: Square bolt

Order #	Item #	Finish	Price
735-0010	6120-308	N/A	\$292.24

KEYPAD ONLY:

Order #	Item #	Finish	Price
735-0015	6120-010	Buffed Brass	\$150.10
735-0020	6120-012	Buffed Chrome	138.18
735-0025	6120-014	Matte Black	138.18



Bring Your Safe Locks Into the 21st Century with Flexible Fingerprint Security



The S&G Biometric Keypad is a replacement keypad that works with many Sargent and Greenleaf electronic safe locks to provide a whole new level of security and convenience. Its unobtrusive, easy-to-use fingerprint reader lets you operate your lock by authorized fingerprint alone, or by code and fingerprint.

Special Keypad Features:

- Designed for a quick, easy retrofit upgrade on many existing Sargent and Greenleaf electronic safe locks.
- Diameter and mounting screw locations are the same as for most other S&G electronic safe locks.
- Top-mounted fingerprint reader is easily accessible.
- Front-mounted backlit LCD guides you through the process of enrolling fingerprints and programming the keypad functions.
- You select the level of security and convenience. Allows your safe lock to be opened by:
 1. Fingerprint only
 2. Fingerprint and PIN code
 3. PIN code only
- Enroll one fingerprint for each PIN position in the lock.
- Quickly remove authorized fingerprints from the system when necessary.
- Integral battery compartment makes battery changes a snap.
- Individually boxed.

Order #	Item #	Finish	Catalog Price
735-0030	6120-410	Bright Chrome	\$896.94
735-0035	6120-411	Satin Chrome	896.94
735-0040	6120-412	Bright Brass	908.92

Sargent & Greenleaf

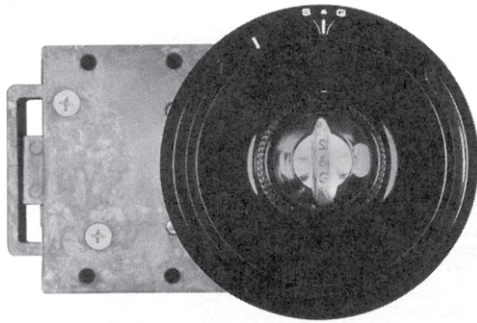

8415-007-8470

8415-107 Premium Security Products Extension 50 Deadbolt

Reversible, surface-mounted lock. For use on doors in high security areas. Two locks in one: a deadbolt and a combination lock.

The Deadbolt

Includes hardened steel pins and interlocking strike and frame to prevent jamming or spreading of the door frame. Equipped with inside release knob for convenient exiting and automatic deadbolt trigger that locks for extra security. Can be set in the locked position while the door is open. Positive locking when the door is closed. Has LOCKOPEN latch, dial can be locked in unlocked position, easing traffic flow without delays.

The Combination Lock

Manipulation-proof to protect against attack, up to one million easily changed combinations. Standard relocking trigger automatically deadlocks the unit if the spindle is punched. Inner workings made of brass, and spyproof dials and rings are standard.

U.L. Listed Group 1 & LR security rating testifies to reliability & performance. Meets military specification MIL-L-15596-E.

Dimensions: 5-3/8" long x 3-7/16" wide. Weight: 2.75 lbs.

**Strike not included,
Order from list at the right.**

735-3470	SRG-8415-107 8470	\$1428.22
----------	-------------------	------------------

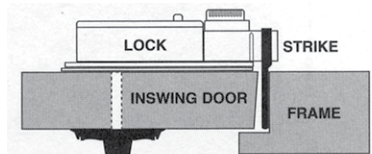
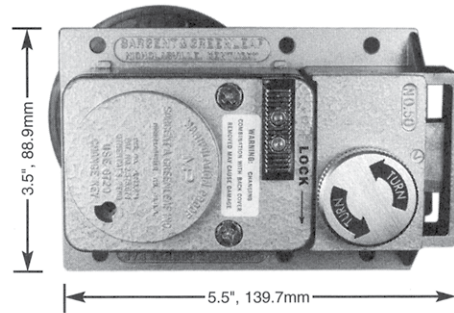

#1 Strike

Product No. 8497-001

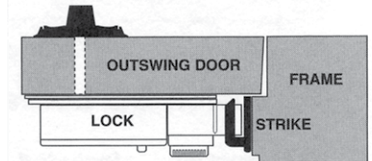

#2 Strike

Product No. 8497-002

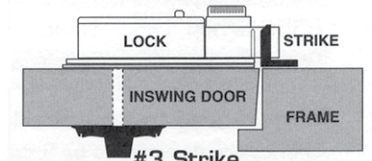

#3 Strike

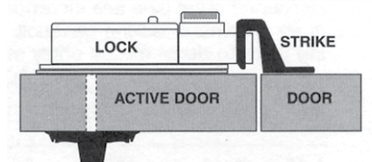

Outswing Double Doors

#9 Strike

Product No. 8497-004

STRIKES

Strike

Description

#1 Single door/
regular bevel
(mortise).

#2 Single door/
reverse bevel
(surface).

#3 Single door/
regular bevel
(surface).

#9 Twin doors/
reverse bevel
(surface).

STRIKES for SRG-8415-107

Lock:

• **Must be Ordered Separately** •

Order #	Item #	Price	Door
735-3471	8497-001 #1	\$50.72	Inswinging
735-3472	8497-002 #2	60.90	Outswinging
735-3473	8497-003 #3	56.34	Surface Mount on Jamb of Inswinging Door
735-3474	8497-009 #9	102.02	Double Outswinging

Sargent & Greenleaf

Group 2 Dials and Rings

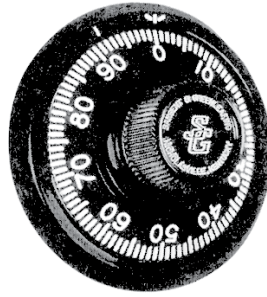

D003 with R004
3.750" (95.3 mm)
ring diameter
B&W finish

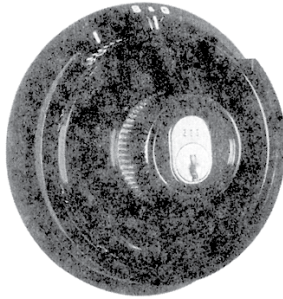

D112 with R162
3.753" (95.3mm)
ring diameter B&W finish
Four pin tumbler key lock: Function
3 only - non key retaining (National
D4291 blank)
This is the only Group 2 type dial
with a pressed *and* pinned spindle.

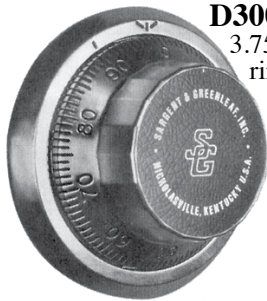

D300 with R211
3.750" (95.3mm)
ring diameter
Satin Brass finish



D220 with R167
3.743" (95.1mm)
ring diameter
Satin Chrome finish

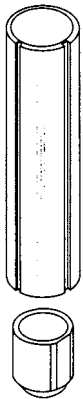

(U) Avail-
able while
supplies last

U24 Tube Kit

A tube must be used with any lock mounted on an insulated safe that does not provide a barrier between the lock's spindle hole and the safe insulation. The tube prevents insulation from infiltrating the lock through the spindle hole.

The U24 kit is used to add a spindle tube to any current production 6630, 6730, 6741, or 8500 series lock. Will accommodate a maximum door thickness of 3.4 inches.

Order #	Item #	Catalog Price
735-3024	(U) SRG-U24	\$14.26

Safe Dials

D003. Front Reading Dial

For all R6700 Series locks. Spindle: 5/16" -40. Used with dial ring R004 Regular Change. Dia: 2.943" (74mm).

735-2024	D003	\$35.00
----------	-------------	----------------

D-112. Keylocking Dial

For all R6700 Series locks. Spindle: 5/16" -40. Used with R162 Dial ring. Diameter: 2.907 (72mm)

735-2034	D112	\$114.50
----------	-------------	-----------------

D-300. Convertible Dials:

Standard Front Reading for 6700 Series. Use with R211 dial ring.

735-2035	D300	\$32.74
----------	-------------	----------------

D-220. Convertible, Spy Proof;

For 6700 Series Combination locks. Use with R167 dial ring.

735-2036	D220	\$38.84
----------	-------------	----------------

Dial Rings

Standard Front Reading. Use with Dial D003.

735-2015	R004	\$20.48
----------	-------------	----------------

Standard Spy Proof. Use with Rings D041; D022; D112.

735-2019	R162	\$26.92
----------	-------------	----------------

Spy Proof Convertible. Use with Rings D041; D220.

735-2020	R167	\$25.02
----------	-------------	----------------

Front Reading Convertible. Use with Dial Ring D300

735-2022	R211	\$18.52
----------	-------------	----------------

Economical

Combination Lock

from Sargent & Greenleaf

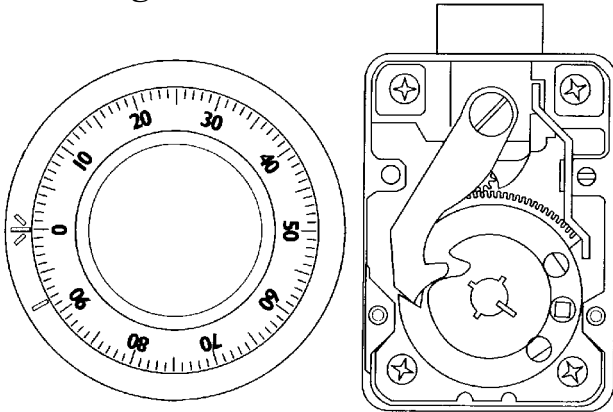

Model 6741

UL Group 2, Combination Safe Locks

This value priced combination lock uses the "magic module" mounting footprint and general design of the 6730 making it interchangeable with the 6730. Uses the 6730 relock trigger assembly, brass bolt, brass 4-way drive cam, metal wheels, spacer washers, brass lever screw and the Spirolox wheel pack retainer.

Components unique to the 6741 include: a one-piece diecast zamac lever, stamped brass wheel flies, single-locking wheel design, wave washer torque control device, diecast wheel centers, 620L clear coat case finish and a one year warranty.

With front reading D300 dial and R211 ring:

Order #	Item #	Price
735-0045	6741-106	\$144.30
735-2008	R6730	179.12

Premium Quality 6730	Value Priced 6741
UL Group 2 Listed	UL Group 2 Listed
Internal Relock Trigger	Internal Relock Trigger
Brass Lever	Chromated Zamak Lever
Machined Brass Wheel Centers	Zamak Wheel Centers
Machined Brass Flies	Stamped Brass Flies
Dual-Locking Wheel Mechanism	Single-Locking Wheel Mechanism
Patented Variable Torque Adjuster	Wave Washer Torque Adjuster
RP Gray Painted Case	620L Clear Coat on Case
Two Year Warranty	One Year Warranty



Dial & Ring Sets

Model D30/R11. 670F21

Standard, convertible, front reading set.
Overall diameter: 3.75" (95mm)
Knob 2.0 (51mm), Splined on 43.
Black & White (Not shown in this finish)

Order #	Item #	Catalog Price
547-0307	670F21-098-41	\$46.20

Model D60/R77. 670P71

Standard, convertible, top reading set.
Overall diameter: 3.38" (86mm)
Knob: 2.32" (59mm), Splined on 43
Satin Chrome

Order #	Item #	Catalog Price
547-0306	670P71-26D-41	\$50.40



Dial & Ring Sets

KABA MAS

D30/R11. Standard, convertible, front reading set.

Overall diameter 3.75" (95mm); Knob 2.0" (51mm); Splined on 43

Order #	Item \$	Finish	Cat Price
547-0309	670F21-26D-41	Satin Chrome	\$52.50

D35/R11. Standard, convertible, key locking, front reading set. Overall diameter 3.75" (95mm); Knob 2.0" (51mm), Splined on 43

547-0310	670G21-098-41	Black & White	\$56.70
----------	---------------	---------------	----------------

D50/R67. Standard, convertible, top reading set.

Overall diameter 3.75" (95mm); Knob 2.61" (66mm), Splined on 43

547-0311	670M41-098-41	Black & White	\$50.40
547-0312	670M41-26D-41	Satin Chrome	56.70

Auditcon Lock Series®



The **52 Series** is a stand-alone single combination access control lock with a dual mode function that provides a small business or individual with the convenience of electronic lockins.

**KABA
MAS**
THE SOURCE FOR SAFE LOCKS



The **Auditcon 100/200/300/400/500 Series** is U.L. Type IR rates. It easily replaces traditional mechanical Group I and Group II locks, upgrading the security of any safe or archive storage unit. Auditcon is perfect for security applications where shared access and audit capacity is necessary.



The **Auditcon 2100** is designed with basic operational programs and a variety of programming options. It can be used as a stand-alone safe lock, or when used with its proprietary PC software, as a sophisticated, electronic security system. Plus, it retrofits obsolete, mechanical dial locks to restore the integrity of your safe.

Auditcon® Lock Series

The best deterrent to insider theft is the certainty of discovery. With Auditcon®, discovery is inescapable.

Utilizing the innovative, award-winning PowerStar™ technology, Auditcon's security cannot be compromised by outside manipulation and provides unprecedented audit capability.

Features and Benefits

PowerStar™ Technology. Self-powered. No batteries, no wiring, no maintenance

Access Control. Models with SmartKey capability offer dual-level security that requires a four digit PIN and personal encoded key to gain access.

SmartKeys. Allows convenient data download and transport for PC viewing.

Audit Trail. User's ID is recorded every time the lock is opened.

Touch Key Number Pad. Change, add or delete PIN combinations with the touch of a button.

Wrong Try Lock-out. Hackers are locked out after 5 wrong combinations.

Economical Replacement. Utilizes the same footprint as most conventional mechanical combination lock.

Time Delay. Delay entry for 1 to 99 minutes.

Time Delay Display. LCD displays the time, informing the user when access will be granted.

Battery Assist for Time Delay (T52 only). 9-volt battery will continually flash the LEDs throughout the duration of a Time delay or Open Window Period.

Dual Mode. Requires the combination and/or Smart keys of two users to gain access.

Silent Duress Alarm. (100-2100 Models). Safely lets employees comply with intruder's demands while alerting authorities.

Quick and Easy Entry. Can be opened in seconds with the correct combination.

Windows 98/2000/NT/ME Software. Optional Audit Only software allows you to save or print audit trail information from your PC. The 2100 model can be fully programmed using the Auditcon 2100 software package.

Choice of Bolt Designs. The "Slide Bolt" automatically locks when the safe handle is closed. The standard "Dead Bolt" functions like a traditional mechanical combination dial lock.

Technical Support. Kaba Mas Technical Support Staff is available 24 hours a day, seven days a week. Call 800-950-4744.



Auditcon Lock Series®

Businesses that have multiple employee access, multiple locations, absentee ownership, or high employee turn-over are ideal for Auditcon locks. Auditcon locks can secure safes, containers, vaults, and restricted areas for Restaurants, ticket box offices, Convenience stores, Grocery stores, department Stores, Drug stores, Jewelry stores, Banks, Hospitals, Casinos, Police Stations, etc.

OPTIONS:

Catalog Price

Remote Time Delay Display

547-0160	307025	\$225.00
----------	--------	-----------------

Duress Alarm Interface Kit

547-0170	301040	\$107.50
----------	--------	-----------------

Dallas Keys. Mas-Hamilton Personal Identifier Keys

547-3000	Personal ID Keys	\$45.82
----------	------------------	----------------

Auditcon Lock Series® Specifications and Ordering Information

52 series has no time delay.
Time Delay Display is option on all listed, and standard on the 2100
Time Windows are only on the 500 and 2100.

Order #	Item #	Bolt	Housing	Combination	PC Software	Alarm Interface	Cat. Price
547-0050	52R	Dead	Round	6 digits	-	-	\$306.26
547-1050	52V	Dead	Vertical	6 digits	-	-	306.26
547-0020	52V	Slide	Vertical	6 digits	-	-	289.12
547-0040	100R	Slide	Round	8 digits	optional*	optional	362.50
547-0200	200R	Dead	Round	8 digits	optional*	optional	362.50
547-1200	200V	Dead	Vertical	8 digits	optional*	optional	362.50
547-0090	200V	Slide	Vertical	8 digits	optional*	optional	362.50
(U) 547-0130	500V	Dead	Vertical	8 digits	optional**	optional	762.50
547-0140	500V	Slide	Vertical	8 digits	optional**	optional	762.50
547-0150 (U)	2100 D	Dead	Vertical	8 digits or 4 digits & SmartKey	Yes ***	Yes	1087.50

* Audit only
** Audit/Programmable Time Windows
*** Full Programming and Auditing

Audit Trail Info	#52	#100	#200	#400	#500	#2100
Number of Events (in sequential order)	-	10	100	200	400	888
Time/Date Stamp	-	-	-	Yes	Yes	Yes
Audit Trail Report	-	Optional	Optional	Optional	Optional	Yes



X-09™ High Security Locks

Meets FF-L-2740A

Make your safe the safest with the X-09, electromechanical lock. Approved by the GSA for use on approved Class 5 and Class 6 filing cabinets and Class 5 and Class 8 Security vault doors. Self-powered using PowerStar™ technology (an internal self-activating power-plant), and features a limited view LCD display.

A twist of the dial provides all the power necessary to enter the combination, as well as review audit features. The X-09 provides all of the benefits of high-security electronic locking while maintaining the reliability of a mechanical lock, independent of batteries or outside power sources. It's security with a twist.

Since the X-09 is not subject to mechanical limitations, it provides a far superior solution for your container needs. The tamper-resistant X-09 can not be "hacked" because the digital information is hidden in the processor's non-volatile memory.

Three Modes of Operation

- **The Single Combination Mode**, allows access by dialing a six-digit combination.
- **The Dual Combination Mode**, allows access only when two separate codes are entered within 10 seconds of one another.
- **The Supervisory/Subordinate Mode**, allows access by a subordinate only after a supervisor code has been entered.

Audit Feature

The X-09 has a full compliment of auditing features, including non-resettable openings log, and unsuccessful attempts log (audits after 3 unsuccessful attempts) that resets once the proper access code is entered.

PowerStar™ Technology

Generates its own electrical energy with each turn of the dial. No batteries, wires or hassles. Its's electronic access control - with a twist.

Combination Changes: LCD indicators in change key mode.

Random Number View: True Scramble

Daylocking: No

Back Dialing: No

Lock Reset: Automatic when bolt is thrown or 40 seconds after turning has stopped.

Combinations:

Single Mode: 1 million

Dual Mode : 500 billion

Supervisor/Subordinate Mode: 2 million

Direct Dial: No need to clear before entering combination.

Dead Zones: None

LCD: Limited View Liquid Crystal Display with indicator arrows makes dialing easy and exact.



X-09 Combination Locks

Order #	Item #	Catalog Price
547-0007	X09S-RD-00N-Z-J-E-1A	\$2047.50
547-1005	X09S-RD-00F-Z-J-E-Z-A1 with Flush Bolt	\$1950.00

Combination Door Unit

Integrated with a rim deadbolt platform, the X-09 represents a unique and complete high security door lock solution while complying with most safety requirements. Along

with the X-09, the combination door lock unit is added to form the CDX-09 which allows you to have access control on any door. Conforms to FF-L-2890.



Order #	Item #	Strike included	Cat. Price
547-1008	CDX09	with #1 Strike	\$2652.00
547-1009	CDX09	with #2 strike	2652.00
547-1007	CDX09	with #3 strike	2652.00
547-1011	CDX09	with #9 Strike	2652.00

Strikes Kits Only

		Catalog Price
547-0001	#1	\$25.46
547-0002	#2	54.94
547-0003	#3	48.24
547-0009	#9	81.74

External Mounting Plates

547-1012	114014 Drill Resistant	\$798.14
547-1013	111204 Non Drill Resistant	126.64



Dependability has never been so easy and affordable.

The Kaba LC Series



Comes with an exclusive spindleless slide bolt and features multiple user capability.

The LCLX is a breeze to install, program and operate, and offered at a very affordable price.

Field Programmable Functions

Single Mode. One combination is required to open lock, Manager (User) or User 2. Manager must add and enable User 2.

Dual Custody Mode. Both user 1 and user 2 combinations are required to open lock.

Super Master Control. A 6-digit code is used to reset lock to Factory Defaults (optional)

All functions are field programmable. A Wrong Try lockout Penalty of 3 minutes will start after 5 wrong combinations are entered.

Certifications: UL Type 1 listed; VdS Pending
EnV1300 Pending

LCLX Housing is Lexan with Black faceplate.

PowerSaver circuit utilizes a 9-volt alkaline battery where power lasts virtually for the shelf life of the battery.

Memory. Programmable nonvolatile Flash memory for 1 or 2 users.

Applications. The UL type 1 rating allows many different application types. For retrofit applications, the Slide bolt Lock body can be mounted over the spindle hole. Bolt works must be present to drive slide bolt.

Powersaver Battery Lock

Order #	Item #	Catalog Price
547-0010	LCLX (Slide) Black	\$168.76
547-0015	LCMX (Slide) Brass	310.00



Model 673 Complete Safe Lock

low cost, 3 wheel combination lock, mechanical.

With D30 dial, R11 ring. Includes mounting screws, instructions, dial bushing, change key, and spline key. 4.58" (116mm) zinc spindle and splined on 43.

Cross Reference: S&G 3330ADJ.

Order #	Item #	Catalog Price
547-0301	673F21-098-41	\$110.26

Mosler Safe Lock Service Kits

Order #	Item #	Catalog Price
547-0303	N69876 (Kit A)	\$292.96
547-0304	N69877 (Kit B)	206.26
547-0305	N69882 (Kit 9)	152.90



Mechanical Safe Locks

Complete with a lock, dial, and ring.

Model 673, Premium 3-wheel combination lock

With D30 dial, R11 ring.

Order #	Item #	Finish	Cat Price
547-0315	673F21-26D-41	Satin Chrome	\$116.00

Model 684, 4 wheel combination lock.

With D50 dial, R67 ring

547-0313	684M41-09841	Black & White	136.50
547-0314	684M41-26D-41	Satin Chrome	141.76

Cencon System 2000® ATM Locking Systems



The Cencon System 2000 is designed to combat insider theft from ATMs through the combined use of lock hardware, systems software and Smartkeys. Total access control and accountability with its One Time Combination feature. The One Time Combination is dispatched from a central location and cannot be reused at a later date, thus eliminating temptation.

Unique software allows you to control and monitor tens, hundreds, even thousands of locks located anywhere in the world - from one central location. A revolutionary and cost-effective solution to today's most serious challenges.

Features and Benefits

Access Control. A user needs both a One Time Combination and a SmartKey to access the lock.

A **One Time Combination** is dispatched each time access is required to a container controlled by a Cencon lock.

SmartKey. An encrypted electronic key, used as a personal identifier, programming device or to transfer data between system components.

Close Seal acts as an electronic signature, stamping the date and time showing the lock was locked and secured.

Duress. When combined with a connection to an alarm system, entering a special "Duress" Combination will automatically send a silent alarm.

Bolt Switch. Comes standard with the capability to connect an alarm system to monitor the position of the lock bolt.

Alarm Shunt Operation. Compatible with most alarm systems.

Audit Trail. Records all lock activity up to 956 events, and permits easy downloading of the information via a SmartKey for generating detailed audit reports.

Easy Retrofit. Same footprint as conventional mechanical combination locks.

User Friendly Software. Allows you to control hundreds of containers with no special wiring. The Windows 95/98 point-and-click interface makes it simple to install and use.

Dial & Keypad
3.79" H x 3.83"
W x 1.38" D

Lock Body
2.4" H x 3.34"
W x 1.19" D

PowerStar Technology

Use of an internal generator creates all the necessary power. No batteries or external wiring required.



Three Modes of Operation.

Cencon locks can operate in any of three modes - one for the First Line Maintenance personnel (FLM Mode), one for cash replenisher or armored service (Route Mode), and one for bank employees (Bank Mode). Each mode addresses the individual access needs for each category of user. Cencon System 2000 locks can be operated in any of these three modes - individually or in combination.

ATM Locking System for 55mm Door w/alarm shunt:

Order #	Item #	Catalog Price
547-4010	201236 S2000	\$1041.26

Implementation Package. Includes Cenbank Windows V2.0 Software, Classes (Call for more information)

Order #	Item #	Catalog Price
547-4011	201116	\$10,250.00

SmartKeys. Catalog Price: \$42.76

Order #	Item #	Description	Color
547-4030	212030	ASM, A	Orange
547-4026	202026	ASM, SS	Grey
547-4024	202024	ASM, D	Black
547-4023	202023	ASM, B	Aqua
547-4022	202022	ASM, R	Yellow
547-4021	202021	ASM, SA	Red
547-4020	202020	ASM, F	Blue
547-4025	202025	ASM, S	White

Combination Lock

Group 2, 3 Wheel Standard, Key Change.

Cross Reference: S&G 6730.

Order #	Item #	Catalog Price
547-0302	673000-60-41	\$79.00

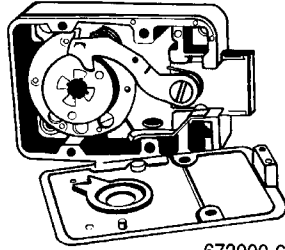

673000-60-41

Safe Handles

1/2 Inch Diameter

Order #	Item #	Finish	Price
547-0512	260775-63-91	River Black	\$26.26
547-0513	260775-26D-91	Satin Chrome	30.46

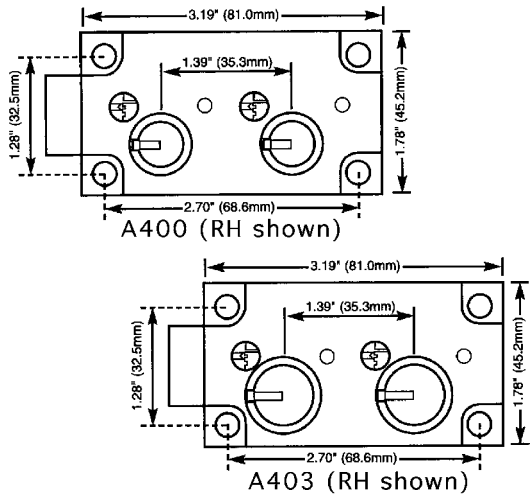
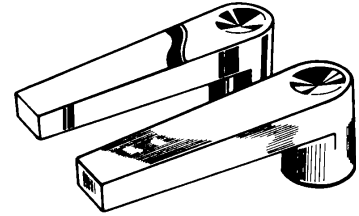

Safe Deposit Locks

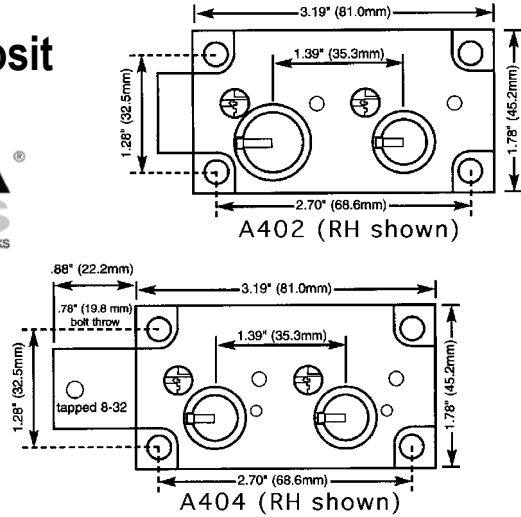

A40 Series Safe Deposit Locks. Packed with one guard key per lock.

Order #	Item #	Description	S&G	Price
547-0500	(U) A400100-04-41-RH	DLN, Fixed, 1/2" nose height	4440	\$31.50
547-0501	A400100-04-41-LH	DLN, Fixed, 1/2" nose height	4440	31.50
547-0502	A402100-04-41-RH	BNLN, Fixed, 1/2" nose height	4442	31.50
547-0503	A402100-04-41-LH	BNLN, Fixed, 1/2" nose height	4442	31.50
547-0504	A403100-04-41-RH	DBN, Fixed, 1/2" nose height	4443	31.50
547-0505	A403100-04-41-LH	DBN, Fixed, 1/2" nose height	4443	31.50
547-0506	A404100-04-41-RH	DLN, Fixed, 1/2" nose height Dual Control, Anti-pull, long bolt	4444	31.50
547-0507	A416100-04-41-RH	A416 Right hand		\$30.00

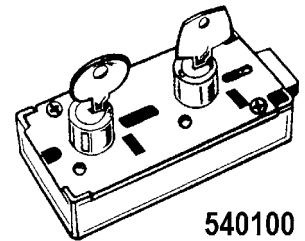

540100

54 Series Safe Deposit Locks. Packed with one guard key per lock.

547-0508	(U) 540100-04-41-RH	DBL changeable, 1/2" nose height		\$64.00
547-0509	540200-04-41-BC1	DBL, changeable, 3/8" nose height Mosler 701-705		45.00
547-0510	544100-04-41	Fixed renter, fixed guard, 1/2" nose height		34.50

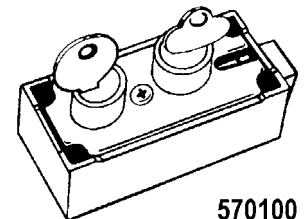

570100

57 Series Safe Deposit Locks. Packed with one guard key per lock.

595-5700	570100-04-41	Retrofits Mosler 5700 & 3175 SM75 guard, brass front		\$52.50
----------	--------------	---	--	----------------

**Diebold
Safe Deposit Lock
Parts**

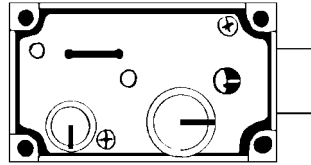

Parts:

220-3900	03-900	Key posts for 175-05	\$2.80
220-3904	03-904	RH lid assm. for 175-05	41.08
220-1534	03-1534	LH lid assm. for 175-05	29.38
220-3632	03-632	Original Key Blank	1.68

ILCO

For Mosler

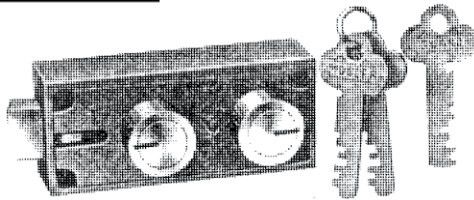

#5700

Replacement.

595-5700	570100-04-41		\$52.50
----------	---------------------	--	----------------

Original Mosler Parts:

595-4080	74080	Lid Assembly	\$9.46
595-4081	74081	Key Post	6.04

Sargent & Greenleaf

Cabinet Locks

Single Horn

- Lever Operated.

Nose Diameter: .672"
(17.1mm)

Changeable Lever Type
Two keys with each lock,
KD. Brass plated covers
and plugs. Easy to re-key,
High degree of picking
resistance.

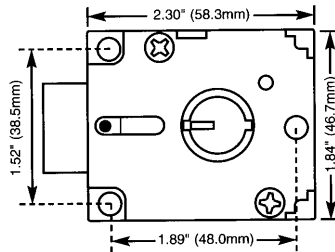
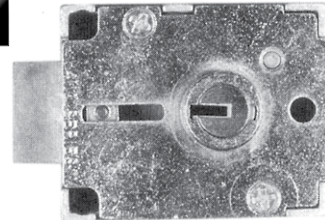

Non-key retaining **\$50.08 ea.**

Order #	Item#	Nose Height
735-4113	4113	1/2"

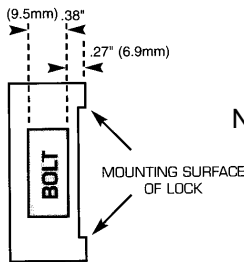

Sargent & Greenleaf

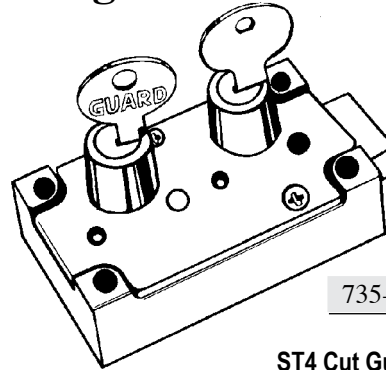

Renter's Key: **\$3.64**
735-0060 SRG 60

#4 Guard Key:

735-4000	\$26.24
----------	----------------

ST4 Cut Guard Key for 4443

735-4003	\$26.24
----------	----------------

Double Horn - Fixed Tumblers.

Order #	Item #	Bolt Throw	Posts	Price
735-4440	4440 RH	1/2"	Sm/Sm	\$50.00
735-5440	4440 LH	1/2"	Sm/Sm	50.00
735-4444	4444 RH	29/32	Sm/Sm	98.56
735-4442	4442 RH	13/32	Lg/Sm	50.00
735-5442	4442 LH	13/32	Lg/Sm	50.00
735-4443	4443 RH	13/32	Lg/Lg	50.00
735-5443	4443 LH	13/32	Lg/Lg	50.00

Sargent & Greenleaf

PARTS:

Parts For #4440:

735-2044	4440-016-002	Front Cam	\$4.20
735-2042	4440-004-080	Front Renter plug (flat)	7.10
735-2039	4440-002-006	RH Cover	13.50
735-2040	4440-002-007	LH Cover	13.50
735-2041	4440-004-077	Rear Guard Plug (flat)	7.10

Parts For #4442:

735-2044	4440-016-002	Front Cam	\$4.20
735-2052	4443-004-082	Front renter plug (flat)	7.10
735-2045	4442-002-003	RH Cover	17.04
735-2046	4442-002-004	LH Cover	17.04
735-2041	4440-004-077	Rear guard plug (flat)	7.10

Parts For #4443:

735-2044	4440-016-002	Front Cam	\$4.20
735-2052	4443-004-082	Front renter plug (flat)	7.10
735-2047	4443-002-003	RH Cover	17.78
735-2048	4443-002-004	LH Cover	17.78