

# MISC. & COMMERCIAL HARDWARE

## Index

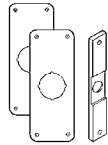

### A

Adapter Plates	15, 17
Adaptor Rings	4
Aluminum Thresholds	24, 25

### B

Blank Channels	14
----------------	----

### C

Continuous Hinges	10, 11
Cylinder Guard Plates	19
Cylinder Guards	7, 22

### D

Door Bottom Sweeps	10, 25
Door Bumpers	20
Door Holders	7, 18
Door Jamb Armor	2, 3
Door Jamb Reinforcers	19
Door Reinforcers	14, 15, 16
Door Stops	18, 20
Door Viewers	23
Drip Strips	26

### E

Elbow Catches	18
Electric Strike Boxes	9
Energy Transfer Hinge	12
Escutcheons	23

### F

Filler Plates	4, 17
Filler Plate Sets	23
Fire & Smoke Seals	26
Floor Dome Stops	7

### H

High Security Strikes	16, 17
Hinge Pins	16
Hinges	10, 12, 13
Hole Covers	17
Hole Fillers	4

# MISC. & COMMERCIAL "NON-LOCKING" HARDWARE

## SECTION 11

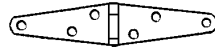

### K

Kick Plates	6
Knob Protectors	9

### L

Latch Guards	17
Latch Protectors	5, 16
Lever Adaptors	8
Lip Strikes	17
Lock Blockers	22

### M

Modernization Kits	23
--------------------	----

### N

Neoprene Sweeps	25
Nylon Brush Seals	26

### O

Offset Pivot Sets	20
-------------------	----

### P

Pivots	20
Pull Plates	6
Push Plates	6

### R

Rod Protectors	5
Rosettes	23

### S

Scar Plates	4
Strikes	18, 21

### T

Thresholds	20
------------	----

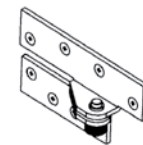
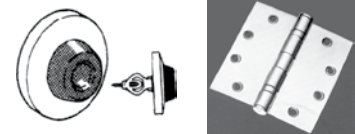

### V

#### Vendors

ADAMS RITE	20
COMMAND ACCESS	12
DON-JO	4, 5, 6, 16, 18
DOOR JAMB ARMOR	2, 3
DU SEUNG	23
EXTEND INC.	8
HAGER	10, 25
HPC	7, 22
IVES	7
KEEDEX	9
KWIKSET	23
LINDUSTRIES, INC.	8
MAG	14, 15, 16, 17, 18, 23
MAJOR	19
MARKAR	11
NGP	24, 25, 26
NSP	21
PBB HINGES	12
SELECT HINGES	13
S. PARKER	6
SENTRY	22
STANLEY	12
WEISER	23

Vinyl Seals	25
-------------	----

### W

Wall Door Stops	7
Weldable Gate Boxes	9

# DOOR JAMB ARMOR

**THE MOST EFFECTIVE WAY TO REPAIR AND HELP PREVENT KICK-IN DAMAGE**

**Fix it once, secure it forever  
Install full set in less than an hour**

- Inexpensive and easy way to fix doorjamb that have already been broken and help prevent it from happening again.
- Helps landlords and apartment owners secure vacant properties and prevent vandalism and theft during renovation.



**This WILL Make You Money**  
 Every customer that replaces their locks should buy this product.  
 This will help you sell more high-end deadbolts  
 Add it on to every door that you sell  
 Not available in the "Big Box" stores

Standard Universal Ultra

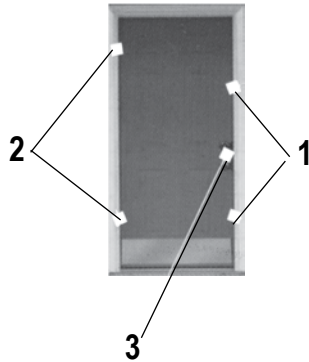

### 1. Jamb Shield

The backbone fo the set, the Jamb Shield is a sleeve that wraps around the lock side of the doorjamb, making it extremely difficult to kick in. Jamb and hinge shields secure to stud with 3-1/2" included screws.

All Jamb Shields are 48" long.

### 2. Hinge Shield

Fits around the existing door hinges and help prevent hinges from being kicked in.



**HINGE SHIELD**

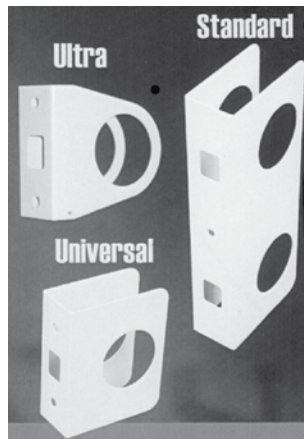

**DOOR SHIELDS**

### 3. Door Shield

Reinforces the lock area of the door and helps prevent the door from being pried open or splitting when kicked.

## DOOR JAMB ARMOR

**STANDARD:** Standard Jamb Shield, 2 Hinge Shields and Standard Door Shield. Designed for doors with standard (5-1/2" on-center) lock spacing. Best for reinforcing or repairing newer doors.

**UNIVERSAL:** Universal Jamb Shield, 2 Hinge Shields and Universal (2-piece) Door Shield. Designed for doors with non-standard (5" to 12" on-center) lock spacing

**ULTRA:** Ultra Jamb Shield, 2 Hinge Shields and Ultra (2-piece) Door Shield. Features knock-out holes to fit almost any lock spacing (or multiple deadbolts). Works on just about any door with a wooden doorjamb.

### Ordering Information

## FIX-A-JAM For Doorjamb Repair

Interior Doors: 1-3/8" thick  
Exterior Doors: 1-3/4" thick



**FIX-A-JAMB**

Order #	Item #	Type	Length	Cat.Price
075-0030	FAJ-INT-10000	Interior	24"	<b>\$59.94</b>
075-0035	FAJ-EXT-10000	Exterior	36"	<b>83.94</b>

Order #	Item #	Door Thickness	Catalog Price
075-0005	SET-ULT-10002	<b>Ultra COMBO Door Jamb Armor Set</b> Includes Ultra Jamb Shield, Ultra Door Shield Set (2-piece set for 2-3/8" Backset), and 2 Hinge Shields. Lock Spacing: 4" to 31"	<b>\$179.94</b>
075-0010	SET-UNI-10002	<b>Universal COMBO Door Jamb Armor Set G2</b> Includes Universal Jamb Shield and Universal Door Shield Set (2-piece set for 2-3/8" Backset). 2 Jam Shields. For 4" to 21" Lock Spacing.	<b>149.94</b>
075-0020	DJA-ULT-10002	<b>Ultra DJA: Door Jamb Armor Set</b> Includes 1 Ultra Universal Jamb & Hinge Shield and nineteen 3.5" screws. Lock Spacing: 4" to 31"	<b>161.94</b>
075-0025	DJA-UNI-10002	<b>Universal DJA: Door Jamb Armor Set G2</b> Includes 1 Universal Jamb Shield & Hinge Shield, and nineteen 3.5" screws. made to fit doors with 4" to 21" lock spacing Fits jambs for 1-3/4" thick doors	<b>131.94</b>
075-0040	DSH-UNI-1000	<b>Universal Door Shield Set</b> (2 piece set) Designed to fit doors with non-standard lock spacing and 2-3/8" backset. Includes 2 Universal Door Shields and four 1-5/8" screws Fits Any Lockspacing	<b>27.54</b>
075-0045	DSH-STD-1055	<b>Standard Door Shield Set</b> with 5.5" on-center lock spacing and 2-3/8" backset. Comes with one 1-5/8" screw	<b>25.14</b>
075-0050	DSH-ULT-10002	<b>Ultra Door Shield Set</b> (2-piece set) Designed to fit doors with non-standard lock spacing and 2-3/8" backset. Includes 2 Universal Door Shields and four 1-5/8" screws. Fits Any Lockspacing	<b>29.94</b>

**DON-JO**

**Door & Latch Filler Plates**

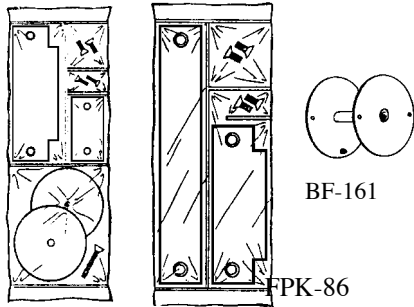

FPK-161

FPK-86

**Filler Plate Kits. FPK-161**

Includes: • BF-161-PC (2-1/8" round hole filler) • BS-260-PC (A.S.A. strike filler) • EF-161 (edge filler) • Fasteners included • Polybagged.

227-0005	DJO FPK-161	<b>\$12.68</b>
----------	-------------	----------------

**FPK-86.** Includes: • EF-86 (door edge filler) • BF-261-PC (A.S.A. strike filler) • Fasteners included • Polybagged.

227-0010	DJO FPK-86	<b>\$9.82</b>
----------	------------	---------------

**Hole Fillers.** Covers up 2-1/8" hole.

227-0015	MAG BF-161-PC Prime Coated	<b>\$5.28</b>
227-0020	DJO BF-161-SL Silver Coated	<b>6.44</b>

**Filler Plates.**

DJO EF-86. 8" x 1-1/4"

227-0030	<b>\$5.20</b>
----------	---------------



**Filler Plate**

Converts Mortise to Electronic Lock

Dimensions: 8" x 1-1/4"

PC Finish: Prime Coated.

Order #	Item #	Cat. Price
227-0375	EL-86-PC	<b>\$12.10</b>

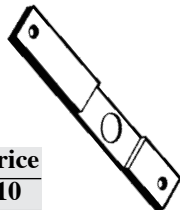

**Filler Plates**

CV-86 Converts 86 cut-out to 161, 8" x 1-1/4"

Order #	Item #	Cat Price
227-0100	DJO CV-86	<b>\$12.68</b>



**Filler Plate. Frame Filler**

Frame hinge cut out.

4-1/2 x 1-5/8. Prime Coated

Order #	Item #	Cat. Price
227-0090	FF-45	<b>\$3.44</b>

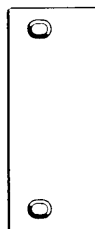

**DON-JO**

**Adaptor Rings**

Fits most standard Grade 1 Key-in-Levers. For use on 1-3/8" doors. Two pieces per package.

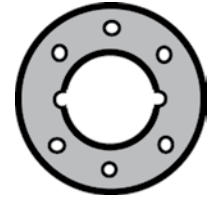

Order #	Item #	Finish	Price
227-0120	DJO AR-335-28	Aluminum	<b>\$16.84</b>
227-0125	DJO AR-335-DU	Duro Coated	<b>18.52</b>

**Scar Plates \$5.14 ea.**

- Covers minor surface damage
- 3-1/2" outside diameter
- 2-1/8" center hole • .032 thickness
- Fits under knob or deadlock rose.

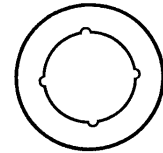

Order #	Item	Finish
227-0360	DJO SP-135-3	Polished Brass
227-0365	DJO SP-135-32D	Stainless Steel
227-0370	DJO SP-135-5	Antique Brass

**Remodeler Plate Kit**

Combines the industry's strongest door edge unit with attractive modern style plates.

**\$50.50 ea.**

227-0350	RPK-109-3 Polished Brass
227-0355	PRK-109-32D Stainless Steel

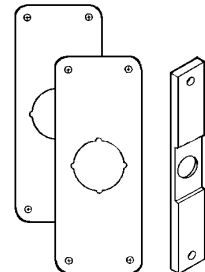

**Hole Fillers, Plate**

PDF-161. Covers up to 2-1/8" hole under rim panic device

Order #	Item #	Cat. Price
520-2125	PDF-161	<b>\$6.70</b>

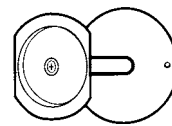

**Blank A.S.A. Strike**  
Prime Coated. 4-7/8" x 1-1/4".

227-0025	DJO FS-260-PC	<b>\$3.00</b>
----------	---------------	---------------

# Latch Protector

**For Aluminum Entrance Doors.**

**Solves pull handle interference.**

- Reversible
- 3/8" offset
- Fits over cylinder - lock removal NOT required
- 12 gauge (.104) steel
- Hand carriage bolt and rivet supplied
- No specific tools required Dimensions: 2 5/8" x 7" x 1/8"

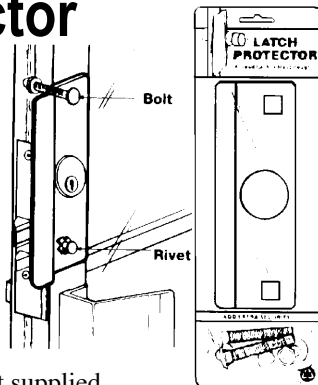

Order #	Item #	Price
227-0300	DJO LP 307 DU	<b>\$16.84</b>
227-0305	DJO LP 307 SL	<b>15.80</b>

# Pin Latch Protectors for Outswinging Doors.

- Solid steel pin prevents spreading of door from frame.
- Pin is welded on back leaving no visible point of attack from outside.
- Extra large cut out accepts up to 3.5" rose.
- Fits 2-3/4 and 2-3/8" Backsets.
- 12 gauge (.104) steel



Order #	Item #	PRICE
227-0130	PLP-211DU Duro	<b>\$17.10</b>
227-0135	PLP-211-26D Satin Chrome	<b>16.26</b>

# Short Latch Protector for Outswinging Doors

Use where larger latch protection won't fit. May be used on hollow metal door using ASA strike plate. 3" x 6".

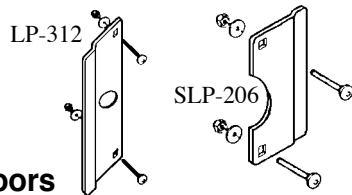

Order #	Item #	Finish	PRICE
227-0060	SLP-206-SL	Silver Coated	<b>\$15.28</b>
227-0065	SLP-206-BP	Brass Plated	<b>16.84</b>

# DJO Outswinging Aluminum Doors

Fits Adams-Rite latch lock. Reversible. 1/4" offset, 1-7/16" hole, 1-1/8" backset, heavy gauge steel. 2-5/8 x 12".

227-0050	LP-312-SL	Silver Coated	<b>\$19.18</b>
227-0055	LP-312-DU	Duronodic	<b>19.18</b>

# DON-JO

## Latch Protectors

### Narrow Latch Protector

Use with locks or escutcheon 3.5" wide or less. Concealed fastener. Heavy gauge steel. 1.5" x 10".

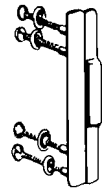

227-0070	DJO NLP-210-PC Prime Coated	<b>\$22.10</b>
----------	-----------------------------	----------------

# DON-JO

## Latch Protector



- Familiar Design
- Designed for Aluminum Doors
- Finishes: SL: Silver  
DU: Duronodic

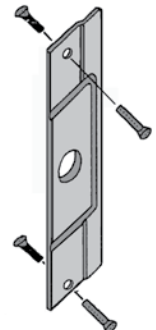

Order #	Item #	Catalog Price
505-1120	AL-211 SL	<b>\$31.20</b>
505-1121	AL-211 DU	<b>31.20</b>

# Latch Protectors

For use with electric strikes. Completely encases the keeper for maximum protection. Silver Coated. 3-1/2" x 8"

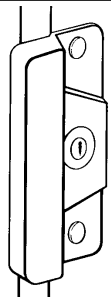

227-0095	ELP-208-SL	<b>\$29.84</b>
----------	------------	----------------

# Don-Jo Vertical Rod Protectors

- Assist in handicap conformance
- Use in hospitals, schools, etc.
- Installs with #6 x 3/4" screws directly into the door
- Installs on any type of wood, metal, or plastic door, any thickness. Covers the latching bolt and lower portion of the vertical rod assembly.

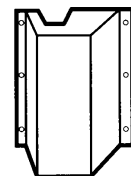
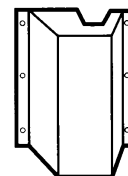

- Fire rated
- Stainless Steel, Satin Finish

**#81**  
Right hand single unit

**#83**  
Left hand single unit

**#85**  
Rod Cover

Order #	Item #	Description	Price
227-0075	#81	2-1/8" projection	<b>\$166.02</b>
227-0080	#83	2-1/8" projection	<b>166.02</b>
227-0085	#85	24" x 1-1/16"	<b>153.40</b>

**DON-JO**

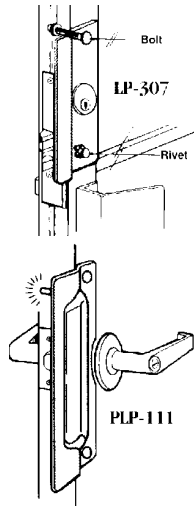

KLP 110 Works with  
ILCO 1000, 4000  
Alarm Lock Trilogy  
Mas-Hamilton Power Levers

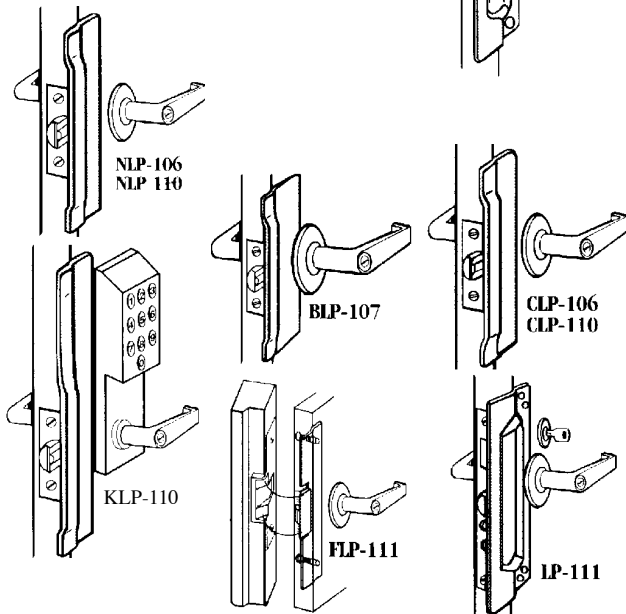

Order #	Item #/	Latch Protector Type	Price
227-1000	LP 307-630	Store Front	\$24.06
227-1005	LP 111-630	Latch	25.02
227-1010	PLP 111-630	Pin Protector	26.98
227-1015	LP 107-630 7"	Latch	32.44
227-1020	CLP 106-630 6"	Commercial	29.90
227-1025	CLP 110-630 10"	Commercial	31.40
227-1030	NLP 106-630 6"	Narrow	25.42
227-1035	NLP 110-630 10"	Narrow	28.40
227-1040	BLP 107-630	Large Rose	22.42
227-1045	FLP 111-630	Folger Adam	62.72
227-1050	KLP 110-RH-630	Keyless	29.84
227-1055	KLP 110-LH-630	Keyless	29.84

**DON-JO**

**PUSH, PULL & Kick Plates**

**DJO Kick Plates**

.050 Gauge, 10" x 34"

Order #	Finish	PRICE
695-0001	US32D	\$54.60

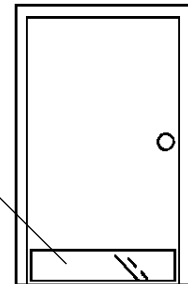

*S Parker Hardware*

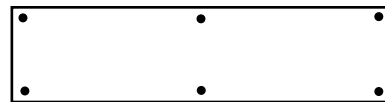

**PUSH**  
4"x16"

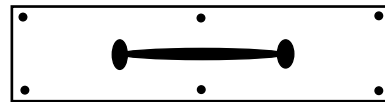

**PULL**  
4"x16"

actual item  
may vary  
slightly from  
picture

**S. PARKER Push Plates:**

Order #	Item #	Cat. Price
695-0040	284 AL16 Alum. Finish	\$18.98
695-0041	284 PB16 Brass Finish	34.90

**S. Parker Pull Plates**

695-0400	285AL16 Alum. Finish	\$47.08
695-0401	285PB16 Brass Finish	75.08

227-1100	Don-Jo 6 X 34-EN .050 Gauge Endurance Kick Plate, Brass Finish	\$85.60
227-1105	PARKER 284SS16 4" x 16" Stainless Steel Push Plate	26.40
227-1110	PARKER 285SS16 4" x 16" Stainless Steel Pull Plate	74.80

**HPC**

**Latch Lock on Doors Opening Out**

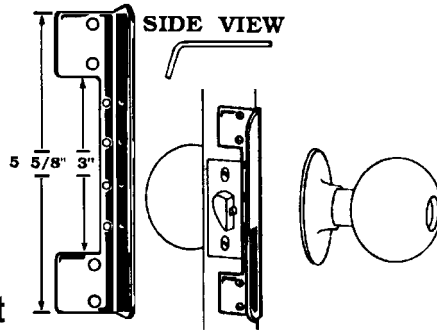

**ODG-6.** Nickel plated steel. Guard plate is screwed directly onto edge of door. Keeps prying tools away from the latch.

Order #	Item #	PRICE
360-0260	HPC-ODG-6	<b>\$18.50</b>

**Doors Opening Out.**

Complete with all necessary hardware.

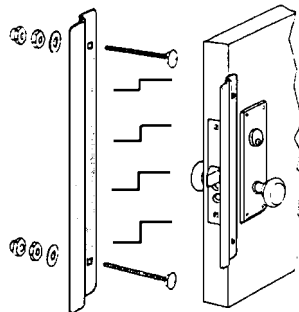

**OVDG.** Bright nickel plated. to be used on outswinging vestibule doors with projecting door casings. For doors not flush to the frame.

Order #	Item #	Offset	Price
360-0264	OVDG-11	3/16"	<b>\$23.50</b>
360-0265	OVDG-12	3/8"	<b>23.50</b>
360-0266	OVDG-13	7/16"	<b>23.50</b>
360-0267	OVDG-14	9/16"	<b>23.50</b>

**HPC GUARD PLATE**

Strongest and most popular guard plate. 14" long made of 2 welded pieces of steel. Baked brown enamel finish. Complete with all necessary hardware.

Order #	Item	PRICE
360-0508	VDG-10	<b>\$25.90</b>

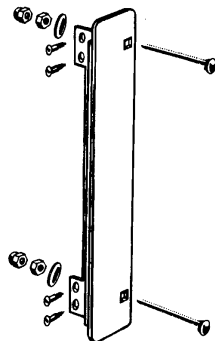

**HPC Narrow Stile Cylinder Guard Plate**

**ADG-1**  
Duro finish, case hardened plate & bolts.  
No special tools required.  
Non-handed.

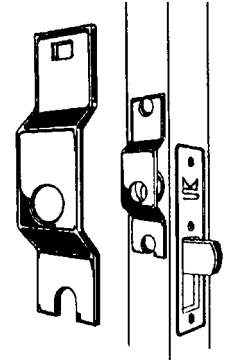

Order #	Item #	Price
360-0007	(U) HPC-ADG-1	<b>\$29.00</b>

**IVES**

**IVES**

**Wall Door Stops**

Concave Rubber.  
With Plastic Drywall Anchor

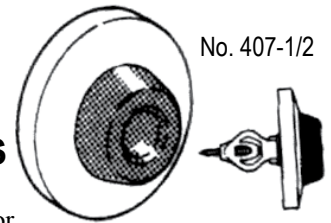

Order #	Item #	Finish	Cat. Price
405-0001	407-1/2	S32D	<b>\$3.24</b>

**New Ives Floor Dome Stops**

One inch height. **Cat. Price: \$5.40**

Order #	Item #
405-0005	FS436 US26D



**Door Holders**

270C, Cast Brass. 1-7/16" x 2-1/8"  
Base, 4-1/8" Arm.  
Non-stock, Available by special order.

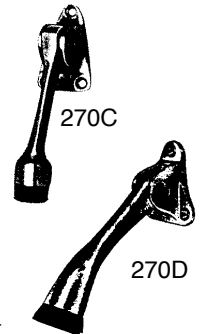

**Kick Down Door Holders 4"**

Special Order | 270D - 26D

**LEVER ADAPTORS**



**LEVERON® Lever Adaptors  
Fit 3 Billion Standard Doorknobs**

- Approved by: Veterans Administration, TEE-84-036 Arthritis Foundation
- FDA Approved for Hi-Glow per 21 CFR 178.3297 (special order finish)
- Made in USA of High Performance Polymer, US Patent #4,397,489.
- Tougher than any die cast metal lever
- Will not corrode, in fact, nothing will stick to it, not paint, adhesive, magic marker, ore even metal plating.
- Leveron's polymer is a better electrical insulator than porcelain, as well as a low conductor of heat.

**LEVERON® Converts Existing Doorknobs to Lever Action for Comply with ADA**

- ANSI A117.1 4.13.9 Door hardware

- Installed quickly without removing doorknob
- One size fits all standard knobsets, right, left, inside, outside
- Engineered resilience to protect knobsets from tough use
- Meets handicapped, fire and safety requirements

Features a patented split-ring which opens and rejoins around teh neck of the knob. The Leveron handle with molded gaskets fits over the knob and is threaded onto the plit-ring, then tightened securely with a cusom wrench (included). The "invisible" fastening system and resilient construction minimizes theft or damage from vandalism.

Order #	Item #	Finish	Catalog Price
245-0050	#0103	Silver	<b>\$48.00</b>
245-0051	#0104	Bronze	<b>48.00</b>
245-0052	#0102	Brass	<b>48.00</b>

**EXTEND  
INCORPORATED**



**HANDI-LEVER**

**Converts Door Knobs to Levers for Easy Access.**

- Opens with one easy motion.
- Does not interfere with existing lock mechanism.
- Installs in minutes, no special tools required.
- **Constructed of strong, Heavy Duty Cast Aluminum.**
- No modification to present doors and locks; slips easily onto existing conventional round door knobs.
- Lever held securely with cap head screw tightened by allen wrench (not-supplied).
- Sold in pairs. For 2-1/8" diameter knobs.
- **Aluminum finish.**

Order #	Item #	Catalog Price
276-0001	EXT-200-218	<b>\$86.80 per pair</b>



**KEEDEX  
Weldable Gate Boxes**

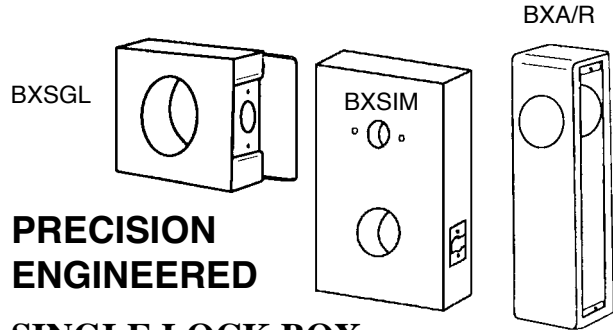
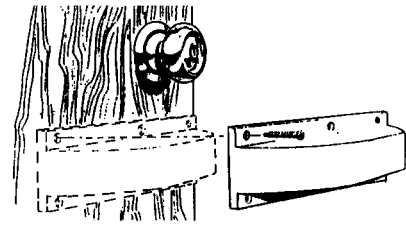

**PRECISION  
ENGINEERED**

**SINGLE LOCK BOX**

2-3/8" backset; 2-1/8" hole.  
Box size: 3-1/2" H x 4-1/2" L x 1-5/8" W.

Order #	Item #	Backset	Price
435-0040	K-BXSGL	2-3/8"	<b>\$9.92</b>
435-0045	K-BXSL234	2-3/4"	<b>28.40</b>

**K-BXA/R. FOR ADAMS RITE**

1-1/8" backset. Lock box for the Adams Rite 1850S, 1851S, 4710 & 4711. Fits the Assa 8508, 8513 & 8518. Also fits International DH1822 & DL 4511. Box dim: 7" H x 1-15/16" L x 1-3/4" W.

Order #	Item #	Price
435-0050	K-BXA/R	<b>\$29.24</b>

**K-BXSIM. FOR SIMPLEX1000 SERIES.**

Box dimensions: 9-1/4" H x 5-1/2" L x 1-7/8" W.

435-0055	K-BXSIM	<b>\$74.76</b>
----------	---------	----------------

**Weldable Gate Box K-BXRHO  
for Schlage Rhodes.**

Order #	Item #	Price
435-0046	K-BXRHO	<b>\$47.60</b>

**Aluminum Gate Lock Boxes**

With the growing trend in the use of aluminum fences and gates, Keedex now provides aluminum versions of their gate lock boxes.

**Aluminum Weldable Gate Boxes:**

Order #	Item #	For	Price
435-0100	K-BXIL-AL	Ilco 70011	<b>\$120.16</b>
435-0105	K-BXSIM-AL	Simplex 1000 Series	<b>125.28</b>
435-0110	K-BXSGL234-AL	Single Gate Box 2-3/4" Backset	<b>68.92</b>

**KEEDEX Knob Protectors**

**KEEDEX # K12.** Saves expensive locks and levers.

435-0012	KEE-K12	<b>\$47.44</b>
----------	---------	----------------

**Electric Strike Boxes**

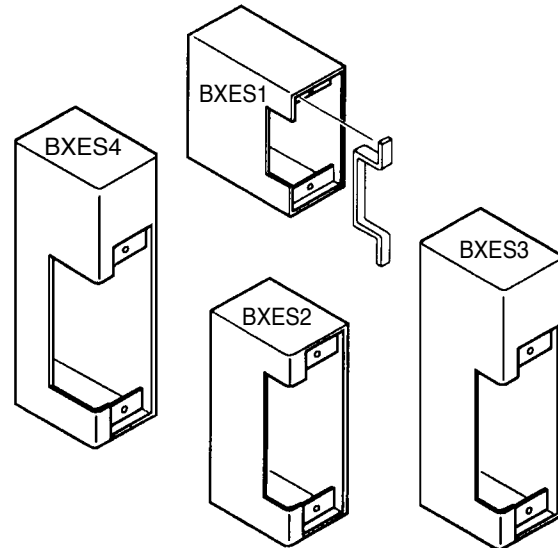

**K-BXES1.** For installing Eff 11BS, Rofu 1106 & Trine 005 electric strikes.

Box dimensions: 3-3/4" H x 3-1/2" L x 1-9/16" W.

435-0060	K-BXES1	<b>\$30.30</b>
----------	---------	----------------

**K-BXES2.** For installing Eff3314, 4114/4314, 5113/5314 & 7114; Rofu 1402, 1702 & 3402 electric strikes.

Dim: 5-1/16" H x 2-3/8" L x 1-3/4" W.

435-0065	K-BXES2	<b>\$29.66</b>
----------	---------	----------------

**K-BXES3.** For the Adams Rite 7800, 7820, 7830, 7840 & 7860 electric strikes.

Box dimensions: 6-7/16" H x 2-3/8" L x 1-3/4" W.

435-0070	K-BXES3	<b>\$30.04</b>
----------	---------	----------------

**K-BXES4.** For Von Duprin 3140 & 6211; Folger Adams 712 & 712-75 electric strikes.

Box dimensions: 6-7/16" H x 2-3/8" L x 1-3/4" W.

435-0075	BXES4	<b>\$35.08</b>
----------	-------	----------------

**HAGER**

# HINGES

**HAGER**

## HAGER HINGES

Give us a Call for  
**FULL MORTISE  
 STANDARD WEIGHT  
 HINGES, LIGHT STRAP HINGES, HEAVY STRAP  
 HINGES . . . All of Your Hinge Needs.**

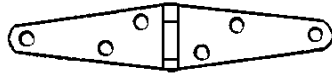

**If its not listed, we can get it!**

## Roton Continuous Hinges

Visit [www.hagerhinge.com/](http://www.hagerhinge.com/) for more information on other models of continuous hinges available.

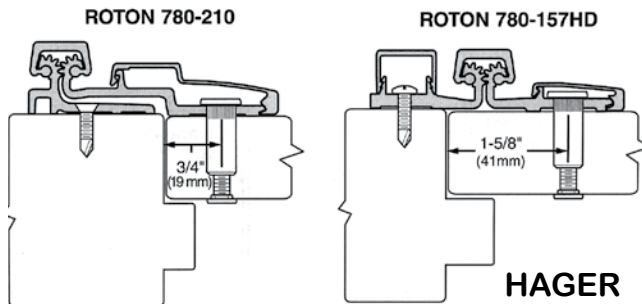

### Standard Duty Commercial Grade

Manufactured with thrust bearings spaced along the hinge length on 5-1/8" centers. The 83" Roton Hinges carries the door weight on SIXTEEN bearings.

### HD Heavy Duty Roton Hinges

Manufactured with thrust bearings on 2-9/16" centers. The 83" hinge carries the door weight on THIRTY-TWO bearings. Supplied with staggered screw holes to suit heavy duty applications such as high traffic entrance ways.

### Check the Load

Divide the weight of the door (including hardware), by the number of bearings in the Roton Hinge under consideration.

- Low frequency interior doors: 20 lbs per bearing
- Med. frequency interior doors: 15 lbs per bearing
- Med frequency exterior doors: 10 lbs per bearing
- High frequency exterior doors: 7.5 lbs per bearing

**83" length. Anodized Aluminum finish.  
 BZ: Bronze Finish**

Order #	Item#	Description	Cat. Price
365-0100	780-210-83	Standard Duty	<b>\$273.84</b>
365-0105	780-210-83 BZ	Standard Duty	<b>369.90</b>
365-0200	780-157HD 83	Heavy Duty	<b>338.36</b>

## HAGER Hinges

### Full Mortise Hinges

#### Standard Weight, Plain Bearing

Steel with Steel Pin. For use on medium weight doors requiring low frequency service. Not for use with door closer. Five knuckle non-rising removable pin, button tip and plug. 4.5" x 4.5". (ANSI A8133)

365-0010	HGR 1279	US26D	<b>\$14.50</b>
----------	----------	-------	----------------

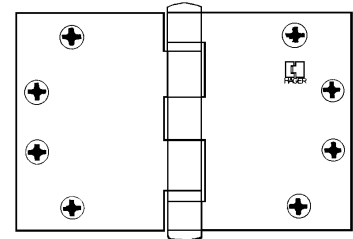

## HAGER HINGES

### Hager BB1191 NRP Standard Weight Ball Bearing 4.5" x 4.5" Hinge

- ANSI A5112 (Stainless Steel)
- Two ball bearings
- Non-removing pin
- Hole Count: 8
- Stainless Steel with Stainless Steel pin
- Hinge Size (inches): 4-1/2 x 4-1/2. (mm): 114 x 114
- Gauge of Metal: 0.134
- Screw Size (Machine): 1/2 x 12-24; (Wood): 1-1/4 x 12



Order #	Item #	Catalog Price
365-0020	BB1191-US32D-NRP	<b>\$66.54</b>

### Ball Bearing, Standard Weight,

4.5" x 4.5" Steel with steel pin ANSI A8112.

365-0030	HGR BB1279	26D	<b>\$26.32</b>
----------	------------	-----	----------------

## 4.5" x 4.5" HAGER HINGES-

*Available in our Atlanta Warehouse.*

Order #	Item # Finish	Price
365-0040	1279 LS	<b>\$11.18</b>
365-0050	BB1279 USP-NRP	<b>26.12</b>
365-0060	BB1279 LS	<b>22.72</b>

## Hager Door Bottom Sweeps

*Available in our Atlanta Warehouse.*

Clear anodized Aluminum  
 w/neoprene insert.

Order #	Item #	Price
365-0070	750SXN 36"	<b>\$19.20</b>
365-0800	750SXN 48"	<b>23.52</b>

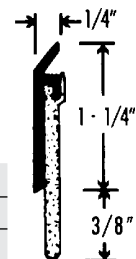

**Markar Continuous Hinges**

can be ordered in a large variety of configurations. Visit [markar.com](http://markar.com) for more information.

**Hinge Prefixes**

- EG Edge Guard
- FM Edge Mount
- FS Full Surface
- HG Hing/Guard
- HM Half Mortise
- HS Half Surface
- SC Swing Clear

**Hinge Series**

The series number indicates the type of hinge and base material used:

- 100 Aluminum barrel hinges with stainless steel pin
- 200 Plain steel barrel hinges with stainless steel pin
- 300 Stainless steel barrel hinges with stainless steel pin
- 400 Spring loaded aluminum toilet partition hinges
- 500 Stainless steel toilet partition hinges
- 800 Aluminum toilet partition hinges
- 900 Spring loaded stainless steel toilet partition hinges
- 1900 Reinforcing pivots
- 2000 Aluminum geared hinges with stainless steel bearings
- 2200 Aluminum geared hinges for 2" doors
- 3500 12 gauge stainless steel pin and barrel detention hinges

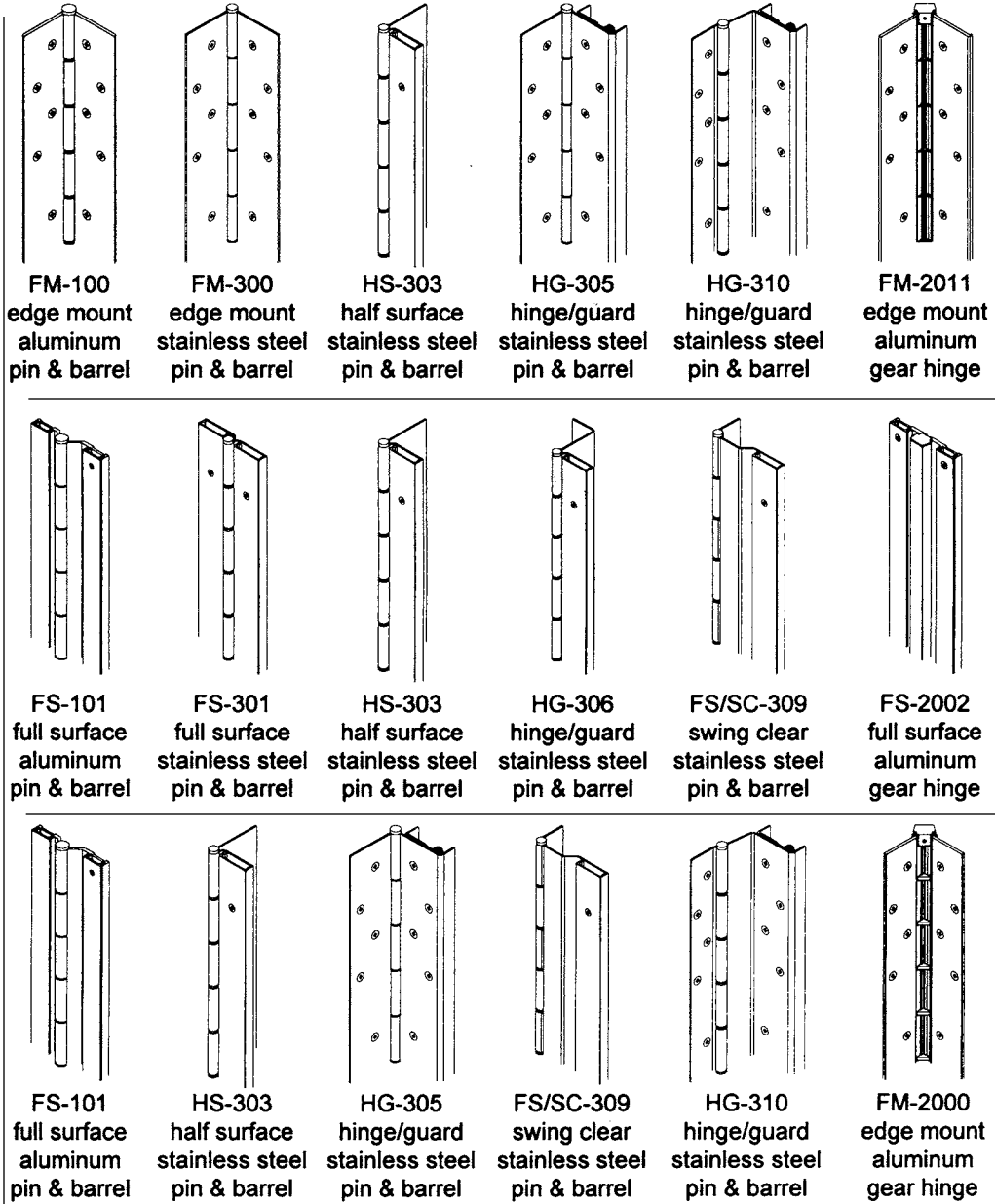

**Hinge Models**

The last two digits of the three-digit model number indicate the application

- 00 Edge mount (formerly full mortise)
- 01 Full Surface, 1/8" offset
- 02 Full surface, flush
- 03 Half surface, 1/8" offset
- 04 Half mortise, 1/8" offset
- 05 Edge mount hinge/guard
- 06 Half mortise hinge/guard

- 07 Double hinge/guard
  - 08 Edge guard
  - 09 Full surface, swing clear
  - 10 Swing clear hinge/guard
  - 11 Edge mount, self-aligning
- Other numbers are used for specific applications

Available in just about any finish you require.

Call your sales rep for more information or visit [www.markar.com](http://www.markar.com)

**Stanley**

**Full Mortise Hinges  
Standard Weight,  
Plain Bearing**

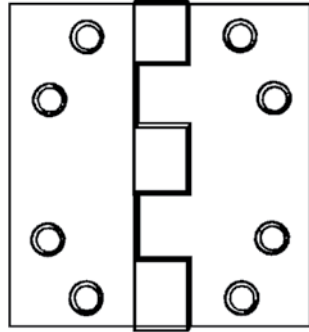

Steel with Steel Pin. 4.5" x 4.5"

846-0010	STN F179	<b>\$6.42</b>
----------	----------	---------------

**Standard Weight, Ball Bearing**

Non Removable Pin, Stainless Steel with Stainless Steel Pin. 4.5" x 4.5" :

846-0020	FBB191 NRP 32D	<b>\$57.72</b>
----------	----------------	----------------

**PBB**

**World Class Hinges**

- **4.5" x 4.5"**
- **Wrought steel, Full Mortise**
- **Plain Bearing (PB).** For use on standard weight doors or doors receiving low frequency usage.
- **Ball Bearing (BB).** Use on standard weight doors receiving average frequency usage. Must be used on doors in conjunction with door closers and on all fire rated openings.

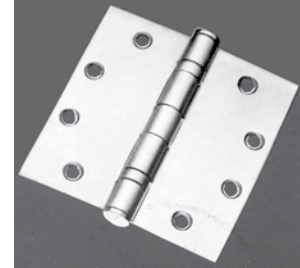

**4.5" x 4.5"**

Order #	Item #	Catalog Price
668-0010	PBB PB81 26D	<b>\$5.40</b>
668-0020	PBB BB81 26D	<b>7.40</b>
668-0030	PBB BB81 USP	<b>7.40</b>

**Comparison Chart**

Type	PBB	ANSI	Hager	McKinney	Stanley	Bommer
Steel Ball Bearing	BB81	A8112	BB1279	TB2714	FBB179	BB500
Steel Ball Bearing	PB81	A8133	1279	T2714	F179	5000

**Command Access**

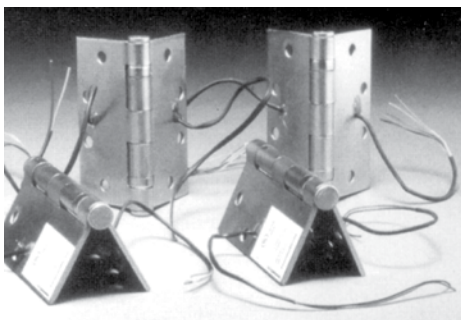

**Energy Transfer Hinge**

Ideal for doors that require concealed low voltage transfer of power from the door frame hinge jamb to the door. Common applications include power to:

- Electrified Locks
- Electrified Exit Device Trim
- Electrified Latch-retracting Exit Devices
- Any application where low voltage power must be transferred from the hinge jamb to the door.

ETH4W - 4 wire energy transfer hinge  
26/19 guage/strand wire - 1 amp. Continuous rating  
3 year manufacturer's warranty • 4.5" x 4.5"

Order #	Item #	Catalog Price
185-0001	ETH-4W4545-US26D	<b>\$160.00</b>



**SL11  
Con-  
cealed  
Geared  
Hinges**

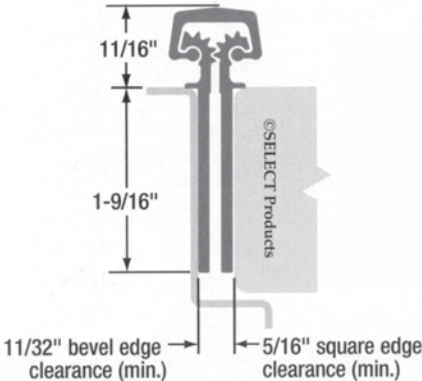
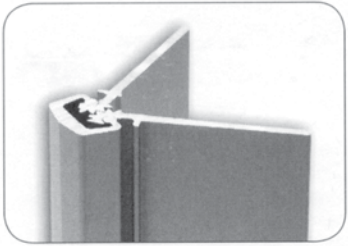

**Material:**  
Extruded 6063 T6 aluminum allow with self-lubricating polyester thrust bearings.

**Ratings:** HD - Heavy Duty. Tested per BHMA standards for high-frequency or heavy, medium-frequency applications. For doors 48" wide in 16 gauge hollow metal or 1/8" aluminum weighing up to 450 pounds without frame or door reinforcement; up to 600 pounds with the use of Rivnuts in the frame and door.

**Closers:** Conventional overhead surface, concealed sliding arm overhead or floor closers may be used with SELECT hinges. Pivot-type floor closers (with a fixed, conflicting center pivot) must be replaced.

**BHMA Certification:** SL11HD geared continuous hinges conform to BHMA Standard ANSI/BHMA A156.26 2006 Grade 1

SL11 83" Hinge **Screw Count:** 19 door & 19 frame screws Grade 1 Continuous Hinge, Concealed, Flush Mounted for 1-3/4" Doors. 83" Length.

Clear CL, Bronze BR,

Order #	Item #	Catalog Price
802-0005	SL11 CL HD 83"	<b>\$147.60</b>
802-0010	SL11 BR HD 83"	<b>190.80</b>

**SL53  
Half  
Surface  
Geared  
Hinge**

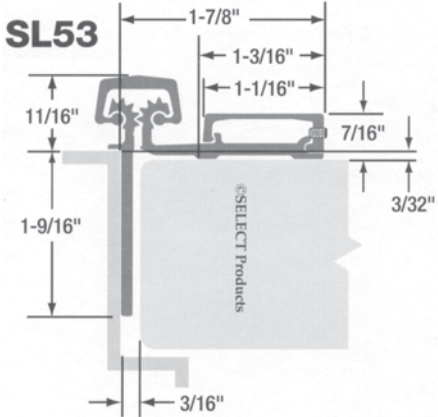

**Material:**  
Extruded 6063 T6 aluminum allow with self-lubricating polyester thrust bearings.

**Ratings:** HD - Heavy Duty. Same as SL11

**Closers:** Conventional overhead surface, concealed sliding arm overhead or floor closers may be used with SELECT hinges. Pivot-type floor closers (with a fixed, conflicting center pivot) must be replaced.

SL53 83" Hinge **Screw Count:** 10 door & 19 frame screws Grade 1 Continuous Hinge, Half Surface, Narrow Frame Leaf

Order #	Item #	Catalog Price
802-0015	SL 53 CL HD 83"	<b>\$211.20</b>
802-0020	SL 53 BR HD 83"	<b>276.00</b>

**INSTALL-A-LOCK**

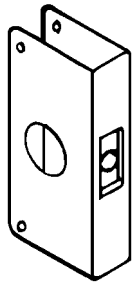

**Door Reinforcers for Deadbolt & Key-in-Knob Locks**

All units solid 22 ga. brass, bronze, or stainless steel, fit square of bevel edge doors. Edge prep recessed to accept all standard latches 1" or 1-1/8" wide x 2-1/4" high. Latch mounting

holes 1-5/8" on center & tapped to accept 8-32 machine screws (furnished).

For installing cylindrical door locks with 2" or 2-1/8" bore. (Strike included). **\$25.22**

1-3/8" Door		1-3/4" Door		Backset	Dim.
Order #	Item	Order #	Item		
520-0012	1S	520-0022	2S	2-3/8"	4" x 9"
520-0014	1AB	520-0024	2AB	2-3/8"	4" x 9"
520-0018	1PB	520-0028	2PB	2-3/8"	4" x 9"
520-0032	3S	520-0042	4S	2-3/4"	4.25 x 9"
520-0038	3PB	520-0044	4AB	2-3/4"	4.25 x 9"
----		520-0048	4PB	2-3/4"	4.25 x 9"

For **Schlage Rhodes & Arrow Sierra Lever Locks**. **\$35.06**

----	520-0045	4PB-2	2-3/4"	4.75 x 9"
----	520-0046	4S-2	2-3/4"	4.75 x 9"

**For Cylindrical Deadbolts**

with 1-1/2" bore. **\$16.10**

Finishes:  
S: Stainless Steel  
AB: Antique Brass  
PB: Polished Brass

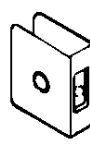

(U) 1-3/8" Door	1-3/4" Door	Item	Backset	Dim.	
520-0052	5S	520-0062	6S	2-3/8"	4" x 4.5"
520-0072	7S	520-0082	8S	2-3/4"	4.25 x 4.5"

**For Cylindrical Deadbolts**

with 2-1/8" bore. **\$16.10**

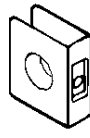

1-3/8" Door		1-3/4" Door		Backset	Dim.
Item	Item	Item	Item		
520-0512	51S	520-0612	61S	2-3/8"	4" x 4.5"
520-0514	51AB	520-0614	61AB	2-3/8"	4" x 4.5"
520-0518	51PB	520-0618	61PB	2-3/8"	4" x 4.5"
520-0712	71S	520-0812	81S	2-3/4"	4.25 x 4.5"
520-0718	71PB	520-0818	81PB	2-3/4"	4.25 x 4.5"

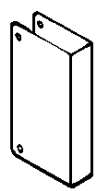

Finishes:  
S: Stainless Steel  
AB: Antique Brass  
PB: Polished Brass

504

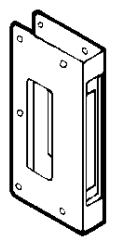

**Blank Channels**

Mounting holes only.

1-3/8" Door (U)	1-3/4" Door	Dim.	Price	
	520-0402	40S	4.25" x 9" <b>\$25.22</b>	
	520-0408	40PB	4.25" x 9" <b>25.22</b>	
520-0702	70S	520-0802	80S	4.25" x 4.5" <b>16.10</b>

Mortise Locks (Face Plate: 1.25" x 8") 2-3/4" Backset

----	520-5042	504S	5" x 12"	<b>\$54.74</b>
------	----------	------	----------	----------------

**For Simplex 1000 & 5000 Series Locks & Alarm Lock DL-2500**

2-1/8" Bore, 4-1/4" from Bottom, 2-3/4" Backset, for doors 1-3/4" thick. Size: 5" x 14".

**14" for Mortise Conversion.**

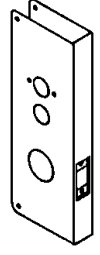

Order #	Item #	Price
520-1026	1000-14S	<b>\$49.18</b>
520-1005	1000-14AB	<b>49.18</b>
520-1003	1000-14PB	<b>49.18</b>

**For Key in Knob Conversion.**

Size: 5" x 9".

2-3/4" Backset, 1-3/4" Thick Doors.

520-1009	(U) 1000-9AB	<b>\$35.06</b>
520-1032	1000-9S	<b>35.06</b>

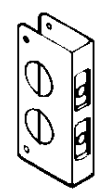

**For Cylindrical Door Lock and Deadbolt in One Unit.**

2-1/8" top & bottom bores. 3-5/8" between centers. **\$28.04**

For 1-3/4" Doors:

Order #	Item	Backset	Dim.	Catalog Price
520-4812	481S	2-3/4"	4.25 x 9"	<b>28.04</b>

**MAG** RETROFIT SOLUTIONS

**Door Reinforcers for Electronic Locks**

Wrap Around - 1-3/4" Door

**5196-14.**

- For Schlage King Cobra
- Overall Size: 5" x 14"

**KC5196-14.**

- For Schlage King Cobra
- Overall Size: 5" x 14"

**1027-14.**

- For Alarm Lock T2 & T3
- Overall Size: 5" x 14"



**DON-JO**

S: US32D; PB: Polished Brass

Order #	Item	For	Cat Price
520-5196	DJO 17-S-CW	Schlage Cobra	<b>\$36.34</b>
520-5199	DJO 17-PB-CW	King Cobra	<b>38.94</b>
520-5200	MAG 1027-14S	T2 & T3	<b>49.18</b>
520-5201	(U) 1027-14PB	T2 & T3	<b>49.18</b>

**Residential Door Reinforcers**

For Deadbolts or Door Locks with 2-1/8" Bore Catalog Price: **\$15.40**

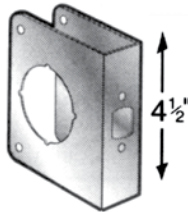

Order #	Item #	Backset	Door Thickness	Dim.
520-1035	2051-SV	2-3/8"	1-3/8"	4x4.5
520-1040	2051AB			
520-1045	2061SV	2-3/8"	1-3/4"	4x4.5
520-1050	2061AB			
520-1055	2081SV	2-3/4"	1-3/4"	4.25x4.5
520-1060	2081AB			

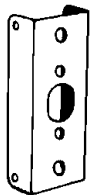

**UNI-FORCE**

Door reinforcement for dead bolt & key in knob locks.

Order#	Item #	For Doors	Price
520-0102	MAG-10S	1-3/8"	<b>\$9.08</b>
520-0108	MAG-10PB	1-3/8"	<b>9.08</b>
520-0202	MAG-20S	1-3/4"	<b>9.08</b>
520-0208	MAG-20PB	1-3/4"	<b>9.08</b>

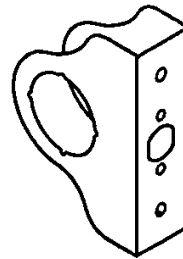

**Traditional Door Reinforcer.**

Designer Series (Visual Pack)  
For all locks with 2-1/8" bore.

For 1-3/4" thick doors. 2-3/8" Backset, Size: 4" x 6"

Order #	Item #	Finish	Catalog
520-2000	(U) 2066-ABV	US5	<b>\$21.02</b>
520-2005	2066-PBV	US3	<b>21.02</b>

**MAG Door Reinforcers**

For Schlage Rhodes, Arrow Sierra, Corbin Russwin 800, Sargent 10, Yale 5400N. 2-3/4" Backset, 1-3/4"

Door Thickness. Overall Size: 4-3/4" x 4-1.

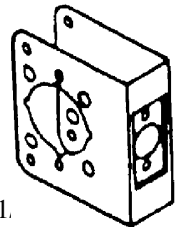

Order #	Item #	Price
520-0081	81-S-2	<b>\$23.80</b>



**DOOR REINFORCERS**

**Covers Simplex Prep.**

2-1/8" Bore 4-1/4" from Bottom, for Key-in-Knob.

2-3/4" Backset, 1-3/4" Door Thickness.

Overall size, 5" x 14"

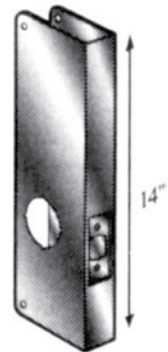

Order #	Item #	Price
520-0985	1004-14S US32D	<b>39.26</b>

**Adapter Plates**

2-3/4" Diameter

For Installing Schlage Deadbolts with 1-1/2"

bore in a 2-1/8" Bore

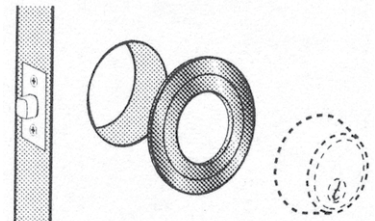

(2 per card)

Order #	Item #	Price
520-2130	8863-C chrome	<b>\$5.56 cd</b>
520-2135	8863-B brass	<b>5.56 cd</b>

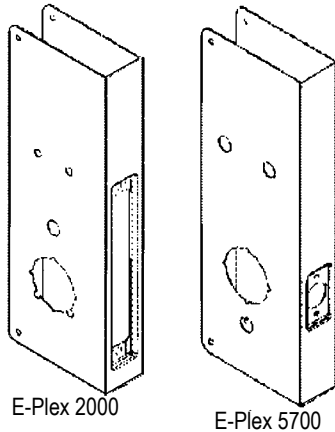

**Kaba-Ilco  
E-Plex 2000  
and E-Plex 5700  
Door Reinforcers.**

Stainless Steel finish  
2-3/4" backset  
for 1-3/4" Door Thickness  
Overall Size: 5" x 14"

Order #	Item #	Fits	Catalog Price
520-5210	1005-14S	E-Plex 5700	<b>\$46.42</b>
520-5205	520-S	E-Plex 2000	<b>\$46.42</b>

**DON-JO**

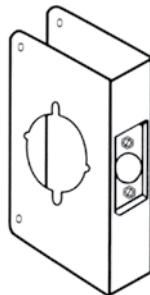

**For Installing the Best 93K  
Lever Lock, 73K Lockset,  
Sargent 6500 Series**

2-3/4" Backset, 1-3/4" Door.  
Dimensions: 4.75" x 5.5". "S" finish: 630.

Order #	Item #	Catalog Price
227-1060	5K-S-CW	<b>\$22.04</b>

**Flat Goods Note:**

When a manufacturer discontinues an item, if we find a suitable replacement, we will substitute the item.

Example: You order a MAG plate that was discontinued, we find a Don-Jo replacement and send it.

**HINGE PINS**

**Don-Jo  
Hinge Pins/Window Bolts**

Locked door can't be removed from jamb even with hinge pins removed. Acts like a deadbolt on the hinge side of the door. For Wood or Metal.



**CHP-100  
#12 Head**

**RHP-100  
#10 Head**

Order #	Item #	Head Size	Catalog Price
505-1185	CHP-100BP	#12	<b>\$3.88</b>
505-1186	RHP-100BP	#10	<b>4.10</b>

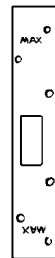

**Don-Jo  
High Security Strikes**

2-SDS: 1-5/8" x 8" for 1-3/4" door

Order #	Item	Cat. Price
110-2000	2-SDS-8 BP	<b>\$13.58</b>
110-2500	2-SDS-8 SL	<b>13.58</b>

2-SDS

**Don-Jo  
Interlocking  
Latch Pro-  
tectors**

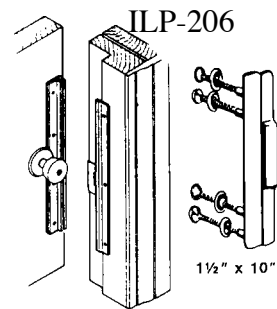

For inswinging doors. Protects latch, interlocks door & frame, Resists jimmying & prying, 12 gauge steel construction, One way screws.

227-0035 (U)	ILP-206-BP 6" Brass Plated	<b>\$18.00</b>
227-0045	ILP-206-SL 6" Silver Coated	<b>18.20</b>
227-0040	ILP-212-SL 12" Silver coated	<b>20.16</b>



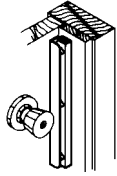

### Latch Guards

#### 7" Latch Guard,

For in-opening doors, all backsets, deadbolts and key-in-knob locks. Reinforces door and frame, prevents spreading of frame. Hardened concealed screws.

Order #	Item #	Catalog
520-2020	MAG 8840-B	<b>\$13.98</b>
520-2025	MAG 8840-C	<b>13.98</b>

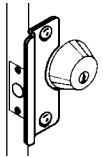

#### 6" Latch Guard

For out-opening doors, all backsets, deadbolts and key-in-knob locks. Protects latch or bolt, heavy gauge steel. Accepts up to 3-1/2" rose.

520-2035	MAG 8845-C	<b>\$11.18</b>
----------	------------	----------------

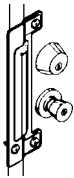

#### 11-3/4" Universal Latch Guard

Out-opening doors; single locks, double locks up to 6" on center, combination locks, mortise locks and access control locks. Protects latch or bolt, conceals lip of existing strike, reinforced mounting area, anti-spread security pin.

520-2045	MAG 8850-C	<b>\$16.78</b>
----------	------------	----------------



#### 12" Removable Latch Guard

Heavy gauge steel with anti-spread pins. For Single or double acting doors with cylinder guard.

Order #	Item #	Catalog
520-2055	MAG 8854-AL	<b>\$28.04</b>

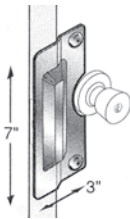

#### Latch Guard, Heavy Duty 7"

##### For Out Opening Doors

All backsets, deadbolts and key-in-knob locks. Protects latch or bolt. Heavy Gauge Steel, accepts up to 3-1/2" rose. 7/16" offset 12 GA. Carded

520-7010	8848-C	<b>\$12.58</b>
----------	--------	----------------

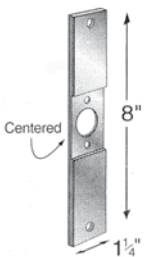

#### Filler Plate, 1-1/8" x 2-1/4"

For 161 Cut-out. Carded

B=Brass. PC=Prime Coat

520-7020	8873-B	<b>\$3.10</b>
520-7025	8873-PC	<b>2.52</b>

#### Filler Plates

##### Converts 86 Cut-out to 161 Prep

161 prep is centered on plate. 8" x 1-1/4" 1/4" thick. Individually polybagged with screws.

520-0140	(U) 8893-PC	<b>\$11.86</b>
----------	-------------	----------------

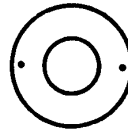

### Adapter Plates

2-5/8" outside diameter. For rim or mortise cylinders. Covers up to 2-1/8" diameter hole. 1-1/4" inside diameter.

Order #	Item #	Catalog
520-2100	MAG 8860-B	<b>\$3.86</b>



### Hole Covers.

2-5/8" outside diameter. Covers 1/2" to 2-1/8" holes. Self-centering disk prevents movement of plate.

520-2110	MAG 8868-B	<b>\$7.66</b>
520-2115	MAG 8868-C	<b>7.66</b>

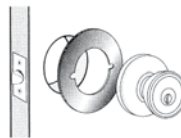

### Cover Plates. 3-1/2" Diameter

For 2-1/8" Bore Locks. Covers damaged door, changes 2-3/8" to 2-3/4" backset, changes 2-3/4" to 2-3/8" backset. 2 per card. C=Chrome, B=Brass.

520-7035	8865-C	<b>\$4.84</b>
520-7040	8865-B	<b>4.84</b>

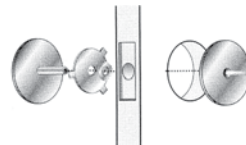

### Hole Cover: 2-5/8" Diameter

Fits 1-1/2" to 2-1/8" holes. Self centering disk prevents movement of plate. Carded.

520-7015	8868-PC	<b>\$5.96</b>
----------	---------	---------------

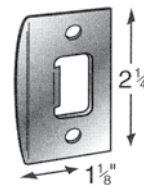

### Replacement Lip Strikes

Full lip. For use on entry or interior doors, adjustable tang. Replacement strike for Kwikset, Schlage, Weiser, and most other brands. 18 ga. 2 per card.

520-7000	718-B	<b>\$2.78</b>
----------	-------	---------------

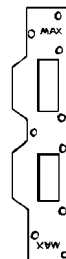

### High Security Strikes

775: 1-5/8" x 11" Double Strike for 1-3/4" door, 3-5/8" or 4" centers.

Order #	Item	Cat. Price
110-3000	775-B	<b>\$15.40</b>

**Strikes for Install-A-Lock**

4-7/8 x 1-1/4" lip strike (ASA cutout)

520-0213	MAG-21B (brass)	\$5.56
520-0215	MAG-21C (chrome)	5.56



**Heavy Duty Box Strike**

with 2" screws. 16 GA. with 18 GA Faceplate. Carded. 4-7/8 x 1-1/4" (fits ASA cutout)

520-7473	MAG-747B (brass)	\$13.98
520-7475	MAG-747C (chrome)	13.98

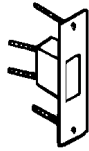

**Deadbolt Strike, Heavy Gauge**

with 1-1/2" long screws. Secures strike to stud. 13 GA. Carded. 6" length.

520-7005	760-B	\$8.36
----------	-------	--------

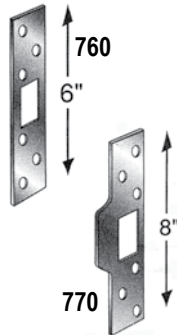

**Lip Strike, Heavy Gauge**

with 3" long screws. Secures strike to stud. 13 GA. Carded. 8" length.

520-7030	770-B	\$12.58
----------	-------	---------



**Adjust-A-Strikes**

2-3/4 x 1-1/4" lip strike \$7.66

520-4503	450B (brass)
520-4505	450C (chrome)

4-7/8 x 1-1/4 Lip Strike \$9.08

520-4523	452B (brass)
----------	--------------

**Don-Jo Wall Door Stops**

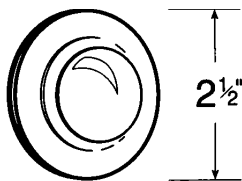

Concave and convex door stops mount to wall behind door. Includes plastic anchor and plastic drywall anchor. 2-1/2" Diameter. ANSI L12101.

Order #	Item #	Type	Projection	Cat. Price
520-9180	1412 626	Convex	1"	\$7.86
520-9181	1412 605	Convex	1"	8.52

**Floor**

**Dome Stops**

Solid brass dome door stops, mount to floor. SMS and plastic anchor fasteners.

"Low Dome" 3/16" x 1" high.

ANSI L12141

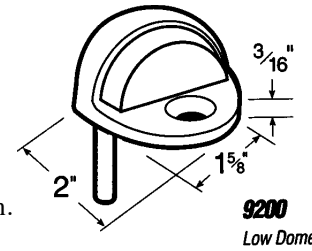

Order #	Item #	Catalog Price:
520-9200	1440 626	\$5.26
520-9201	1440 605	5.46

**Don-Jo Kick Down Door Holders**

Mounts directly to door. Includes mounting screws. 4" Projection, zinc die-cast. ANSI L91382

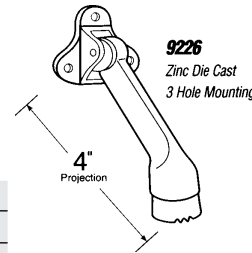

Order #	Item #	Cat. Price
520-9220	1455 CP	\$11.18
520-9226	1455 BP	7.86

**Floor Door Stops Don-Jo**

Heavy duty, solid brass door stops mount to floor. MS, expansion shield and lead anchor fasteners.

2-9/16" x 1-9/16" base, 2-1/8" high.

ANSI L12131

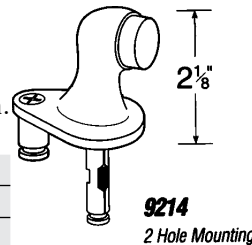

Order #	Item #	Price
520-9214	1450 626	\$20.02
520-9215	1450 605	21.12

**Elbow Catches**

Die cast elbow catch.

1-3/8" x 5/8" base. Includes mounting screws. ANSI L24021

Order #	Item #	Price
520-9284	1590 626	\$3.84
520-9285	1590 605	3.58

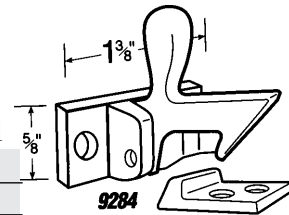

**Door Stops**

Rigid door stops mount to wall. Solid Brass.

ANSI L12031

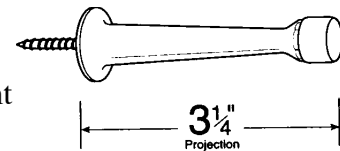

Order #	Item #	Catalog Price
520-9237	1506 626	\$11.06
520-9283	(U) 1506 695	11.06



*Door Jamb Reinforcers*

**JAMB JACKET**

Repairs and Covers Damaged Door Jamb

- Adds reinforcement to undamaged doors
- Covers standard 1/2" rabbeted jamb.
- Recessed accommodate T-strike

24" Long Plate • Non-handed

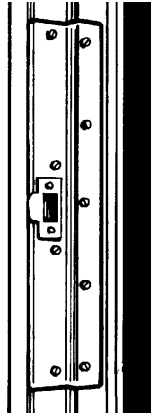

Order #	Item #	Door Thickness	Price
527-0230	JJL-134-24	1-3/4"	<b>\$39.50</b>
527-0235	JJL-138-24	1-3/8"	<b>39.50</b>



**STRIKEGARD**

Easy ADD-ON Sale When Servicing Aluminum Doors!

**Aluminum Door Jamb Reinforcer**

Used to repair an aluminum door jamb that has been damaged due to a break-in or to reinforce a jamb as extra protection against forced entry. Easy installation by drilling six No. 20 holes in the door frame and using the steel pop rivets supplied with strike. 14 gauge cold rolled steel, 5/64" thick. Powdercoat finish.

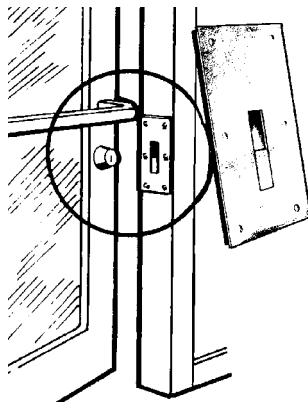

Order #	Item #	Finish	Catalog Price
527-0260	MAJ SGA-1	Aluminum	<b>\$20.50</b>
527-0265	MAJ SGD-1	Duranodic	<b>20.50</b>



**ALUMA-GUARD**

The new Aluma-Guard is designed to protect aluminum framed, glass, store front doors. It forms a shield that will protect both the latch area from attack and the lock cylinder from wrenching.

Mounting is easy with one carriage bolt in the top and a drive rivet in the bottom.



- Formed from cold rolled steel
- 6-1/2" high, 3-1/2" wide, and 7/64" thick.
- Can be installed with the lock still in the door.
- Powdercoat finish

Order #	Item #	Catalog Price
527-0005	AG5-A Aluminum	<b>\$15.00</b>
527-0006	AG5-D Duranodic	<b>15.00</b>

*High Security Latch/Cylinder Guard Plates*

**ALUMAGUARD**  
Forms a Shield of Armor on Latch/Cylinder of Out-Swinging Aluminum Framed Glass Doors.

Protects from Caseknife, Jimmying, Cylinder Pulling, Wrenching, and Door & Frame Separation.

6-7/8" H x 4-1/8" Wide. Powdercoat finish. For out-swinging offset hung aluminum doors.

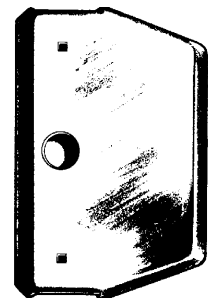

Order #	Item #	Finish	Cat. Price
527-0120	MAJ AG1-A	Aluminum	<b>\$37.00</b>
527-0125	MAJ AG1-D	Duranodic	<b>37.00</b>

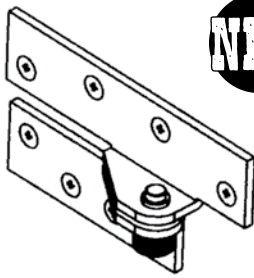

**PIVOTS**

ADAMS RITE

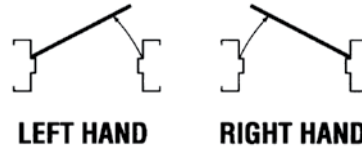

**Full Surface Pivots**

3/4" to center line of 4-1/2" hinge.  
Pin uses large pin and bushing.  
All pivots are handed.

Includes:

- 8 x MP-16 1/4-20 x3/4" Phillips flat head machine screws
- 8 x MP-18 No. 14 x 1-1/4" Phillips flat head sheet metal screws
- 2 x MP-22 1/4-20 x 1-3/4" sleeve bolts, and instructions.

Order #	Item #	Handing	Catalog Price
020-0050	B1923 US2G	LH	<b>\$70.76</b>
020-0055	B1923 US2G	RH	<b>70.76</b>

**TACO**

Available in our Atlanta Warehouse.

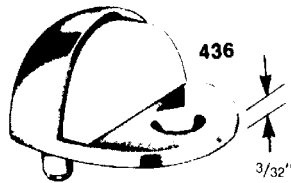

**Dome Door Stops**

Low Profile

Pressure Cast Zinc, individually polypagged with wood screws and plastic anchors. Chrome plated

Order #	Item #	Price
875-0003	DS436 CMD	<b>\$6.58</b>

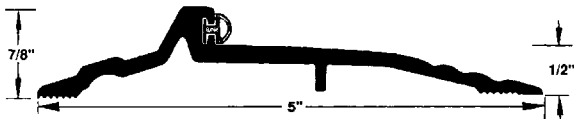

**Heavy Duty Commercial Grade**

**Thresholds. 5" x 36", Aluminum finish**

Order #	Item #	Price
875-0001	T-WS536A	<b>\$66.52</b>

Available in our Atlanta Warehouse.

**Concave Type**

**Wall Door Bumpers**

Pressure Cast Zinc, individually polypagged with wood screws and raul plug. Chrome plated



Order #	Item #	Price
875-0002	WB401 CMD	<b>\$7.62</b>

**3/4" Offset Pivot Sets**

Engineered and designed for durability, style and versatility. All cases are aluminum. Pivots operate on full race ball bearings.

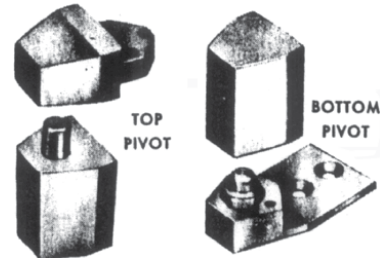

Complete with 1/2" vertical adjustment. No possibility of door sag since entire weight of door rests on floor mounted pivot. Easy to install. Durable, all weather proof acrylic coating protects pivot from deterioration. Top portion has spring loaded hardened pin for easy assembly. When door is in locked position, these pivots are completely burglar-proof. Easily installed or removed from door in only a few seconds.

**FEATURES**

- 1/8" Vertical Adjustment.
- All-weather proof.
- Completely theftproof, yet easy removable, and replaceable in unlocked position.
- Non-handed.
- Smooth, precision-made select ball-bearing operation.
- Complete with screws, anchors, and mounting materials.

**OP-27**

(Cross Reference: Jackson J27)

For Doors Flush with Face of Frame

844-0027	NSP OP-27 Alum	<b>\$37.08</b>
844-0127	NSP OP-27 Duro	<b>37.08</b>

**OP-28**

(Cross Reference: Jackson J28)

For Doors Recessed 1/8"

844-0028	NSP OP-28 Alum	<b>\$37.08</b>
844-0128	NSP OP-28 Duro	<b>37.08</b>



**DG-22 DOR-GUARD SET**

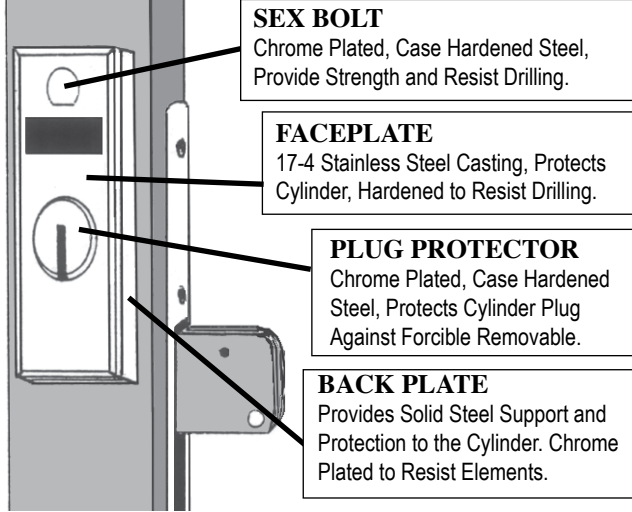

**SEX BOLT**  
Chrome Plated, Case Hardened Steel, Provide Strength and Resist Drilling.

**FACEPLATE**  
17-4 Stainless Steel Casting, Protects Cylinder, Hardened to Resist Drilling.

**PLUG PROTECTOR**  
Chrome Plated, Case Hardened Steel, Protects Cylinder Plug Against Forcible Removable.

**BACK PLATE**  
Provides Solid Steel Support and Protection to the Cylinder. Chrome Plated to Resist Elements.

**MAXIMUM SECURITY**

**DG-22 DOR-GUARD SET**

Designed to protect mortise cylinders on narrow stile aluminum doors. Engineered to give maximum security against forcible unauthorized entry by removal of cylinder or cylinder plug.

Can be used with any brand of Mortise Key Cylinders including Medeco and Most other brands of High Security Mortise Key Cylinders.

Order #	Item #	Price
844-0201	DG-22 Stainless	<b>\$31.04</b>
844-0202	DG-22 Duro	<b>31.04</b>

**STD PACKAGE.** Each Guard is Boxed with All Necessary Parts and Fasteners for One Assembly. Approx. Shipping Weight: 1 lb.

**S-LINE**

**A.N.S.I. Strikes**

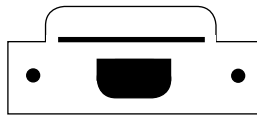

Item #	Order #	PRICE
S-5164-US3	845-5163	<b>\$4.84</b>
S-5164-26D	845-5164	<b>4.00</b>



**DorGard III™**

HPC/Scotsman



A common problem with narrow stile aluminum doors is attack at the door jamb. An unprotected door is subject to a pry bar spreading the door and the jamb, or even ripping out the jamb, allowing unauthorized entry. Sawing the bolt has also been a means to gain unlawful entry. DorGard III™ will thwart all of these attempts, as well as guard the lock cylinder.

The DorGard III™ provides the same cylinder protection as the DorGard II™, plus has the added benefit of a hardened steel latch protection plate. Cast in one piece, with ribs on the back for added strength, the latch plate has two pins that will rest in holes drilled into the door jamb. This innovative pin feature adds another level of security to the door by linking the door and the jamb together. The perfect choice for electric strike applications; it adds security to the convenience of electric strikes. It completely conceals the area of the lock bolt and strike, and blocks all access to the lock and cylinder. The DG3 can be used with any cylinders from 15/16" to 1-3/8" (2.38 x 3.50cm) in length.

Non-handed so it can be used on right or left handed doors.

DG-series door guards are available in either a Satin Stainless or Duracoat Bronze finish, providing an extremely durable and attractive finish. Mounting hardware and illustrated installation instructions are included. We suggest using the HPC TK3 installation kit.

Order #	Item #	Catalog Price
360-0125	DG3-APS-10	\$302.00

**SENTRY  
LOCK BLOCKERS**

LG-2A

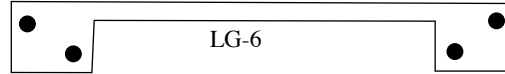

**Sentry Lock Blockers**

Adaptable on both out and in swing doors.

Order #	Item #	Finish	Price
805-0002	SEN-LG-2A	Alum	<b>\$11.70</b>
805-0012	SEN-LG-2A	Brass	<b>11.70</b>
805-0006	SEN-LG-6	Alum	<b>20.86</b>
805-0016	SEN-LG-6	Brass	<b>20.86</b>

**Cylinder Guard**

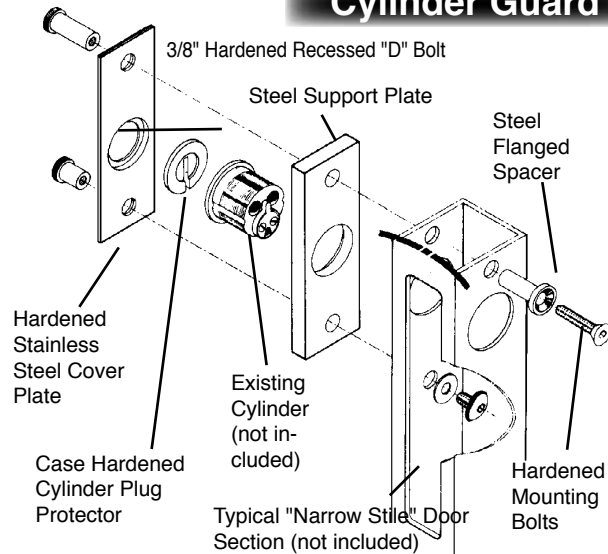

**HPC Mortise Cylinder Guards  
for Aluminum Narrow Stile**

**1" Mortise Cylinder Installations.**



- Prevents forcible removal of cylinders.
- Heavy steel plates encase cylinder.
- 3/8" sheer strength recessed bolts prevent torquing.
- Durable hardened plug for cylinder plug protection.
- Available in Clear Aluminum or Bronze Finish.

Hardened steel box encases the cylinder and fastens through the door with 3/8" hardened recessed bolts.

Repels common drilling equipment. **\$110.00 EACH**

Order #	Item #	Finish
750-0001	DG2-AXS-10	Aluminum

**DOOR VIEWERS**



Quality viewer offering 160° field of vision. Machined from solid brass, with ground glass lens. For doors 1-3/8" to 2" thick.

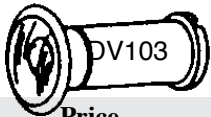

Order #	Finish	Price
920-2310	Brass	\$5.92
920-2311	Chrome	4.68

Four element lens system provides 190° vision field. Fits doors 1-3/8 to 2" thick.

920-2320	Brass	\$7.84
920-2321	Chrome	8.26

**DOORSCOPE Door Viewers**

Identify Visitors Seven Feet From Your Door in Your Room!

**FEATURES**

- Provides 132° of horizontal visibility
- Projects a true image of visitors
- Super wide angle
- Easy to Install in metal or wood doors
- Made of Aluminum: Charcoal Black, Fancy Brass, or Grey Finishes

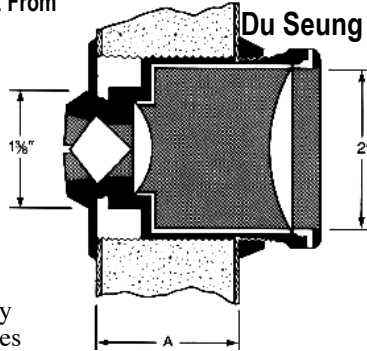

**APPLICATIONS**

Home, Apartments, Condos, Offices, Hotels, Restaurants, Retail Stores, Banks, Hospitals & more!

Order #	Item #	Finish
233-1000	DS/1000 MB	Black
233-2000	DS/1000 MG	Grey
233-3000	DS/1000 FB	Fancy Brass



\$56.56

**MAG DOOR VIEWERS**

Solid Brass, 180° One Inch Diameter, Optical Glass Lens. Carded

520-8728	8728	\$15.44
----------	------	---------

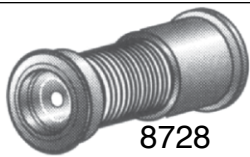

8728

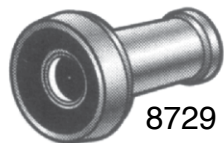

8729

**Wide Angle Door Viewer**

Solid Brass with Optical Glass Lens, fits 1-3/8" to 2" doors. 200° angle of view, 9/16" diameter. Carded

910-0602	MAG 8729	\$12.64
----------	----------	---------

**kwikset**

**Decorative Trim**

**Modernization Kits**

An economical way to replace old mortise locksets without filling in holes left by removal of old lock. Consists of a latch and strike plate and front and back trim plates.

**KWIKSET-214. Used on exterior doors.** Trim plates 10-1/2 x 3-1/2". Latch plate is 8 x 1-1/8".

455-2143	214-US3	\$70.56
----------	---------	---------

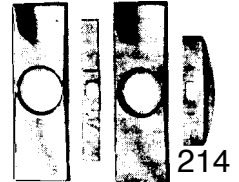

214

**KWI-215. Used on interior doors.** Trim plates 7-1/4 x 3-11/32". Latch plate is 6 x 1".

455-2153	215-US3	\$55.30
----------	---------	---------

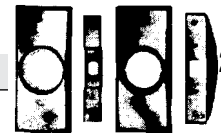

215

**Round Rosettes**

**KWI-293.** 3-13/16" diameter.

Order #	Finish	PRICE
455-2930	26D	\$18.90
455-2933	US3	17.92
455-2935	US5	20.30

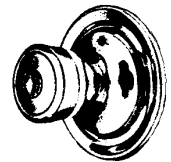

**WEISER Blank Filler LOCK Plate Sets**

For use in filling a 2-1/8" diameter side hole on a door which has been prepared for a lock, but one is not needed. Set consists of two flat blank roses (reinforced), each with threaded post and one screw hole, and a blank latch face. Filler Plates.

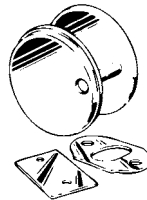

**WEISER-7058.** Blank Latch Face 2-1/4 x 1".

940-0078	7058 26D	\$58.40
940-0076	7058-US3	35.04

**WEI-7059.** Blank Latch Face 2-1/4 x 1-1/8"

940-0090	7059 26D	\$35.04
----------	----------	---------

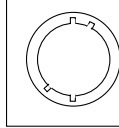

**WEI-1629.** 3-1/2" Square.

Small Escutcheons for use on exterior or interior doors. May be used with all backsets.

940-0028	US3	\$26.40
----------	-----	---------



**WEI-1643.** 3-3/4" Round.

940-0034	US3	\$26.40
----------	-----	---------

**NGP** Aluminum Thresholds

424 .72 lbs./ft.

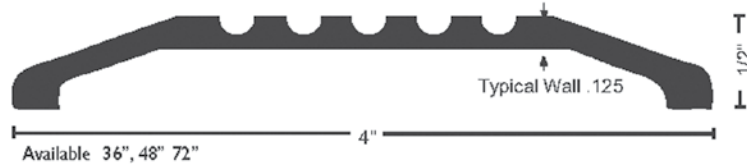

Available 36", 48" 72"

Aluminum mill finish

Item #	Order #	Size	Cat. Price
610-0005	424	36"	<b>\$21.28</b>
610-0010	424	48"	<b>28.36</b>
610-0015	424	72"	<b>42.56</b>

413 .58 lbs./ft.

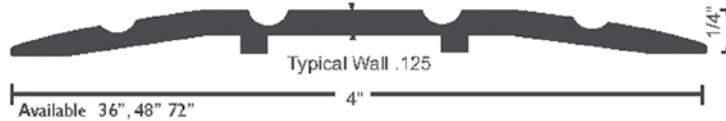

Available 36", 48" 72"

Aluminum mill finish

Order #	Item #	Size	Cat. Price
610-0020	413	36"	<b>\$21.28</b>
610-0025	413	48"	<b>28.36</b>
610-0030	413	72"	<b>42.56</b>



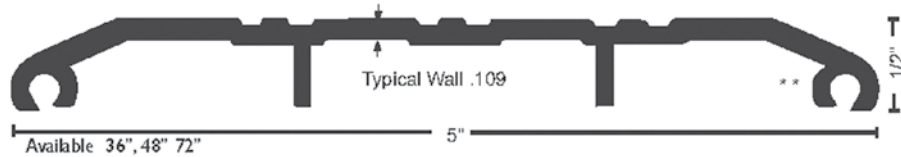

425E .80 lbs./ft.



Available 36", 48" 72"

Aluminum mill finish

Order #	Item #	Size	Cat. Price
610-0035	425E	36"	<b>\$33.58</b>
610-0040	425E	48"	<b>44.78</b>
610-0045	425E	72"	<b>67.18</b>

 ADA Compliant  
 UL10B & CAN4-S104-80M Classified  
 Positive Pressure UL10C Classified  
 **BHMA** Certified (A156.21-2006)





**Aluminum Thresholds**



Aluminum mill finish

Order #	Item #	Size	Cat. Price
610-0050	513	36"	<b>\$33.58</b>
610-0055	513	48"	<b>44.78</b>
610-0060	513	72"	<b>67.18</b>

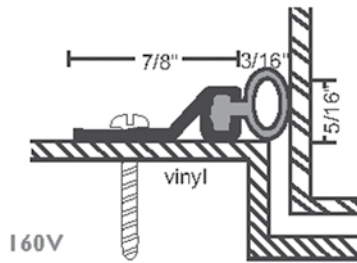

160V  
Available 36" x 86", 72" x 86"

**Vinyl Seals**

- Synthetic polymer: Polyamide
- Economical
- Moisture resistant
- Flame resistant
- Temperature range 0°F to 140°F
- Plasticizers evaporate with age and exposure to UV, Cold, heat causing hardening, loss of memory, loss of resilience, cracking, and crazing

#6 x 3/4" stainless steel sheet metal screws furnished. Screw holes are slotted for adjustment

Order #	Item #	Size	Cat. Price
610-0080	160V	36"x86"	<b>\$26.80</b>
610-0085	160V	72"x86"	<b>31.44</b>



**Neoprene Sweeps**

#6 x 3/4" stainless steel sheet metal screws furnished. Screw holes are slotted for adjustment

Order #	Item #	Size	Cat. Price
610-0065	200NA	36"	<b>\$14.36</b>
610-0070	200NA	48"	<b>19.16</b>

**HAGER**

**HAGER HINGES**

**Hager Door Bottom Sweeps**

Clear anodized Aluminum w/neoprene insert.

Available in our Atlanta Warehouse.

Order #	Item #	Price
365-0070	750SXN 36"	<b>\$19.20</b>
365-0800	750SXN 48"	<b>23.52</b>

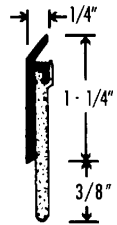

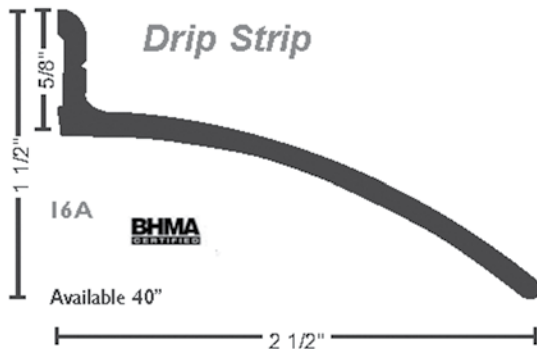
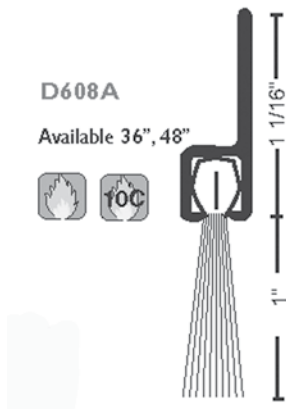
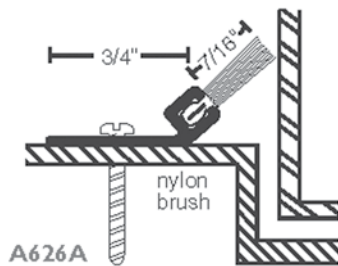

GASKETING

Silicone Bulb Fire & Smoke Seals

Edge sealing system, category "G" for 20 minute rated category B wood doors perimeter application up to: single swing 4'x8', pairs 8'x8' Up to 3 hours steel fire doors Up to 1-1/2 hours wood fire doors Meets requirements of ROHS Directive 202/95/EC Self Adhesive, "C": Charcoal color

Order #	Item #	Size	Catalog Price
610-0090	5050C-17	17' Roll	<b>\$28.56</b>
610-0095	5050C-20'	20' Roll	<b>33.60</b>

GASKETING

Nylon Brush Seals

- Synthetic polymer: Polyamide
- Excellent abrasion resistance, flexibility and memory
- Moisture resistant
- Retains insecticides well
- Temperature range -70°F to 160°F
- BHMA Certified to ANSI A156.22 performance tests for Heat, Cold, Air Leakage, and Smoke Control in most common profiles as indicated by BHMA Certified symbol
- No effective against water penetration.
- Sheet metal screws included

A- Clear with gray brush

Order #	Item #	Size	Catalog Price
610-0100	A626A	36"x86"	<b>\$65.18</b>
610-0105	A626A	72"x86"	<b>76.46</b>
610-0110	D608A	36"	<b>20.42</b>
610-0115	D608A	48"	<b>27.22</b>

Drip Strips

A- Clear

Order #	Item #	Size	Catalog Price
610-0075	16A	40"	<b>\$18.02</b>