

Index

Ace Tools	3, 10, 24, 31, 64
ADA Accessibility Force Guages	48
Adjustment Tools	12
Auto Emergency Tool	13
Books & Manuals	22, 23, 58, 62, 63
Bushing Plates	59
Calipers	39
Capping Press/Blocks	5, 8, 9, 12
Car Opening Tools	7, 15-19, 48, 56-58, 65
Chisels	55
Clip Removal Tools	21
Code Cards	14
Cylinder Cap Removers	44
Cylinder Drill Jigs	21, 24, 51, 56
Cylinder Eater	28
Cylinder Removal Tools	3, 9, 66
Cylinder Removing Tools	42
Decoders	3, 29, 40, 46, 60, 65, 67, 68
Door Guage (ADA)	48
DoorLasers	41
Door & Lock Supports	11
Door Installation Tools	38, 39
Door Jak	38
Drill Bits	24, 49, 65, 68
Drill Jigs	56
Extractors	3, 4, 9, 32, 36
Face Caps	7
File Handles	13
Files	13, 23
Followers	26, 29, 42, 50, 65
Graphite	2
Hammers	3
Hinge Tools	12
Hole Saws	10, 49, 55
Hurricane Door Upgrade Kits	55
IC Core Tools	5, 8-9, 12, 24, 43, 45-46
Illuminated Pin Stations	29
Impressioning Tools	11, 29, 64
Installation Tools	5, 8, 9, 39, 41, 42, 50-53, 59, 60, 67-68
Kelly-Klamp	9
Keycheck	58
Key Gauges	67
Key Handle Covers	10
Key Hooks	64
Keying Kits	10, 12, 42-47, 54, 67, 68

LOCKSMITH TOOLS SECTION 10

Key Punch	6
Key Tag Systems	60
Killer Jig Kit	59
Knob and Lever	21
Lever Opening Tools	40
Lighting Tools	30, 43, 50, 61
Lock Mounting Brackets	50
Lock Plate Compressors	21
Lubricants	2
Magnifying Tools	12, 30, 61
Micrometers	24, 39
Mirrors	19
Multi-Tools	11
Nose and Door Pullers	24
One Way Screw Removers	11
Padlock Defeaters	27, 56
PAK-A-PUNCH	6
Pick Guns	4, 37, 64
Picks	34, 35, 66
Pick Sets	6, 7, 31-34, 48, 63, 66
Pin Block	44
Pin Kits	10, 44
Pliers	21, 25, 64
Plug Holders	8, 9, 12, 26, 29
Plug Spinners	3, 37, 66
Pro-Lok	59
Punch & Die Sets	26, 50
Reforming Tools	48
Removers: Knob and Lever	21, 28
Retaining Ring Pliers	4
Rhodes Nut Tools	64
Router Bits	23, 52, 60
Safe Change Keys	30, 40
Safe Drills	23
Safe Tools	23, 40, 41, 61, 65
Screwdrivers	4, 11, 40
Service Kits	10
Shim Holders	3
Shim Picks	31, 50, 63, 68
Spring Steel	24
Stamping Plates	4
Strike Markers	28, 68
Tap and Die Sets	29
Tension Tools	7, 35-37

TOOLS

Tool Cases	67
Torque Tool	53
Truarc Ring Assortments	25
Truarc Ring Pliers	4, 25
Tubular Lock Picks	31, 64
Tweezers	4, 25
Vendors	
A-1 / HATA	3-9
AMERICAN	10
CCL	10
Century	10
Certified Products Inc.	2
COMPX Chicago	10
DIRES	11
DOOR DOLLY	39
DVS	11
EDROY	12
ESP	11
GENERAL	13
GKL	12
Grobet File Company	13
HARDNOX	38
HPC	2, 14-37
KABA ILCO	39
KC TOOL	48
KEEDEX	39-41
KWIKSET	42
LAB	2, 43-47
MAJOR	49-53
MORSE	49
NSP/S-LINE	54-55
PANEF	2
PLATT	67
Programmed Marketing	54
PRO LOCK	56-65
RYTAN	66
SCHLAGE	67-68
TRI-FLOW	2
WEISER	68
Waffle Trays	9
Wedges	20, 58
Wheel Pullers	66
Window Crank Tools	64
Wire Strippers	5

LUBRICANTS

HPC



Graphite Gun

Refillable, Leak-proof, Clog-proof.
Use prior to picking or impressing.
Loosens tight wafers & pins. Perfect for lubricating key machine carriage shaft & wing nut studs.
Does not attract dust or chips.

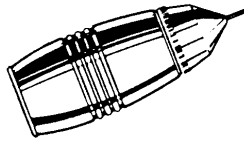

Order #	Item #	Price
360-0163	HPC-HGG	\$18.40 Ea

Bulk Graphite

High quality, finest micro-spray refill graphite. One pound can.

360-0157	HPC-GG-16	\$27.00
----------	-----------	---------

Certified Prod. *Certified Products Inc.*

HOUDINI

4-Way Lock Lube

All purpose high-tech cleaning lubricant for extreme conditions, tough jobs. Works to -60° .

- Neutralizes fingerprint acid
- Drives out moisture
- Does not attract dust or dirt
- Lifts rust, dirt, grease
- Does not sling off moving parts
- Not petroleum based; never gums-up
- Unsticks stuck stuff

11 oz aerosal can, 12 per carton. Deep Penetration.

Anti-Friction - Anti-Corrosion - Anti-Rust - Anti-Wear.

Order #	Item #	Price
169-1101	CER-11101	\$8.70



LAB

LAB LUBE

Teflon powder, an absolutely dry white lubricant. Nothing to congeal or collect dust & dirt.

Order #	Item #	Cat. Price
465-0240	LAB-LLT001	\$36.00



LUBRICANTS

PANEF



PANEF

Lub-A-Spray Dry Graphite Lubricant. 6.5 grams, 12 to a box.

645-0300	PAN-L300	\$28.00/Dozen
----------	----------	---------------

TRI-FLOW

Long Lasting Lubrication with extremely low viscosity and surface tension, TRI-FLOW'S exceptional lubrication virtually eliminates friction - friction coefficient 0.08. With TRI-FLOW the need for reapplication is reduced by up to 90%.

Protects

TRI-FLOW Combines Teflon with complex carrying agents, to form highly durable film, and virtually eliminates wear on moving parts. Falex load test - max load 3700lbs, temperature range -53 C - + 246 C.



Cleans

Dirt, dust, sand and other abrasive matter are dispersed by the bearing action of the Teflon particles. Surfaces are cleaned and kept clean. Repels moisture.

Penetrates

TRI-FLOW'S special non-acidic solvents break down carbon deposits, hardened grease, sludge and grimy film and penetrates even into the most inaccessible areas.

Prevents Corrosion

Displaces moisture, preventing the formation of ice, rust and other corrosives. TRI-FLOW dissolves the crystalline structure caused by moisture, salt and alkalis. Acid-free, it releases seized parts.



Pin Point Lubricator



SINGLE DROP PRECISION

TRI-FLOW

Order #	Item	Cat. Price
880-1200	TFBC20027 Pin Point - Carded	\$12.94
880-2009	TRI-20009. 4 OZ Aerosol	8.90
880-1500	TRI-15000. 6 OZ Aerosol	11.64
880-1700	TRI-17000. 12 OZ Aerosol	19.44
880-0016	TRI-26020. 1 Gallon	123.20

LOCKSMITH TOOLS

A-1



#4. Interchangeable Core Key Decoders

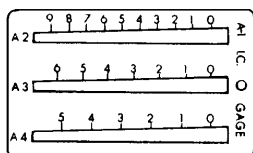

005-0225	# 4	\$35.00
----------	-----	---------

#6. General Motors Lock Decoders



005-0015	# 6	\$71.90
----------	-----	---------

#14. Tubular Lock Saws



Rotary saw for cutting away shoulder over pins to allow tumblers to be removed & lock opened. Permanent, built-in pilot guides on center spindle. Cutter will cut brass or steel locks at low speed (Not recommended or guaranteed for over 1000 rpm).

005-0040	# 14	\$71.90
----------	------	---------

#16. Cylinder Removal Tools



This cam action tool is the best design to remove stubborn, screw type mortise cylinders. This heavy duty automatically adjusts from 15/16 to 1-1/2" diameter. Heat treated and plated.

005-0045	# 16	\$77.90
----------	------	---------

#18. Shim Holders



A tool to hold curved shims firm and straight - no slipping or cut fingers. Complete with 25 curved shims.

005-0055	# 18	\$33.00
----------	------	---------

A-1



#20. Ace Picks



For 137 center key way. Complete with decoding guage (shown), carrying case and instructions included.

005-0060	# 20	\$145.00
----------	------	----------

#26. Plug Spinners



Often times it is almost impossible to pick a lock in the right direction, but easy to pick it backwards. That's when this tool is a must.

005-0080	# 26	\$69.90
----------	------	---------

Extractors

#27.

Broken Key Pullers.

A kit of three different pullers. Spiral, toothed, & hooked. Quality American steel. Vinyl covered handles.

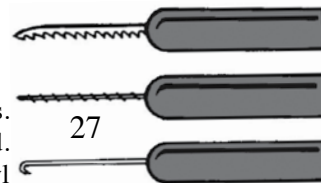

005-0085	# 27	\$33.00
----------	------	---------

#28.

Master Locksmith Hammers



A light weight hammer manufactured to meet the needs of the locksmith. This 2 ounce hammer features a head with one end brass, the other end durable, non-marring plastic.

005-0405	# 28	\$39.00
----------	------	---------

A-1



#29.

5" Grooved Tweezers

Specifically grooved for pinning, these tweezers offer straight parallel blades for ease of top pin loading. Optimum design for Interchangeable Core.



005-0410	# 29	\$31.92
----------	------	---------

#30. Get-A-Grip**Broken Key Pullers Extractors**

A hexagonal handle and large, .040 spiral offers superior ability to Get-A-Grip on stubborn broken keys.



005-0415	# 30	\$7.44
----------	------	--------

#30B. Mega Grip. Broken Key Pullers

Similar to the Get-A-Grip, but with an exceptionally large spiral. Great for use on many imported autos.

005-0420	# 30B	\$9.00
----------	-------	--------

#30 SET. Get-A- Grip Set**2 each of Get-A-Grip and Mega Grip**

005-0425	# 30 SET	\$35.90
----------	----------	---------



#35.

Stamping Plates

Stamp Keys and IC cores with A-1's Stamping Fixture. Manufactured of Delrin so keys won't jump around while stamping. Will hold other blanks including Schlage, Corbin/Russwin, etc.

Order #	Item #	Catalog Price
005-0430	# 35	\$279.00

#41. Security Multi-Driver**Most Extensive, High-Quality Multi-Bit Screwdrivers Available.**

Includes the following security bits:

Torx 9, 10; Hex 3/16, 5/32, 1/8, 9/64; Spanner 4, 6, 8, 10; Phillips #2 and Slotted 7/32. Bits are made of S2 hardened steel. The handle features a 1/4" nut driver and a patented end cap that keeps your stored bits secure.



Order #	Item #	Catalog Price
005-0600	# 41	\$63.90

#42. Retaining Ring Pliers**No More Tips to Misplace**

Unique ergonomic retaining ring plier design allows a natural hand-wrist orientation, which reduces fatigue. A1's innovative tool features integral tips for working internal or external rings, return spring and cushioned grips for your comfort.



Order #	Item #	Catalog Price
005-0605	# 42	\$39.00

#44.

Magnum Pick Guns

Features easy tension adjustment. Includes 3 tips and a tension wrench. The pick gun can be easily disassembled for maintenance. A 5-year manufacturer's warranty is included.



Order #	Item #	Catalog Price
005-0044	# 44	\$55.90

LOCKSMITH TOOLS



A-1

#46. 2 in 1 Automatic Cutter/Wire Strippers

Catch, Hold & Strip in One Quick Motion

Perfect for low-voltage work, this tool cuts wire with one end and automatically strips with the other. Patented stripper in handle automatically self adjusts to wire size - No stripping holes to locate. Strips soft copper (electronic) wire Sizes 26 AWG to 14 AWG.

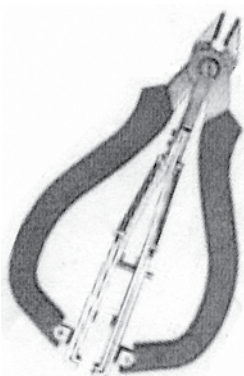

Order #	Item #	Catalog Price
005-0095	# 46	\$25.90

Capping Press/Blocks

CAP-5. CapSaver™ Press

A Revolutionally Concept for Servicing Interchangeable Cores.

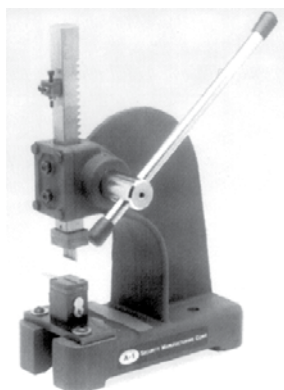

A-1's CapSaver™ Press uses brass strips to punch all caps as your seat them.

Never purchase or place another cap.

The most time consuming task of capping cores is placing the small caps onto each chamber of the core. Using CapSaver strips, the press actually punches and forms the caps as it seats them into the core. Each strip is designed to cap four 6 or 7 pin cores, sold in packs of 50.

Order #	Item #	Description	Catalog Price
005-0300	CAP-5	CapSaver Press	\$1395.00
005-0305	CS-50	Capsaver Strips	51.00/50pk



A-1

MADE IN USA

Installation Innovation!

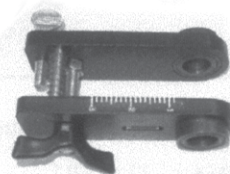

BUL-1

Cabinet Lock Installation Jigs

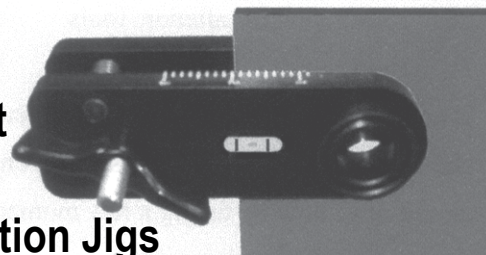

Manufactured of Aircraft Grade Aluminum Alloy, and steel bushings, this jig is designed to install two styles of cabinet locks.

- Cam Locks using 7/8" cross-bore
- Interchangeable Core Locks using 1-1/4" cross-bore
- Both sides of this jig are identical and include 1/8" graduated backset markings. The built-in level provides for easy and accurate setup.

Order #	Item #	Price
005-0140	BUL-1	\$269.90

BUL-2. BULLS EYE

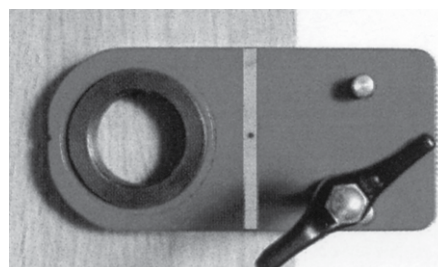

Bulls Eye Installation Tools for Cylindrical Locksets.

Use this tool when locating and drilling crossbores and latch holes when installing cylindrical locks. Economically designed for locksmiths, this new tool is equipped to drill 1-1/2" and 2-1/8" cross bores and includes an automatic backset adjustment that requires no additional tools.

Order #	Item #	Catalog Price
005-0610	#BUL-2	\$425.60

PAK-A-PUNCH™

PAK-3 Automotive Interchangeable Punch Economy and Versatility make this the Punch you've been waiting for.

Versatile automotive punch offers interchangeable punches & dies so you can punch various angles of cut with one machine (comes equipped with the standard 90° set). PAK-3 requires the Quickchange Kits of your choice (some applications may require accessory punches & dies). Kits consist of a depth knob and one or more vises for punching specific keyblanks. Model 3 requires your choice of various Quickchange Kits for auto blanks (Sold separately).

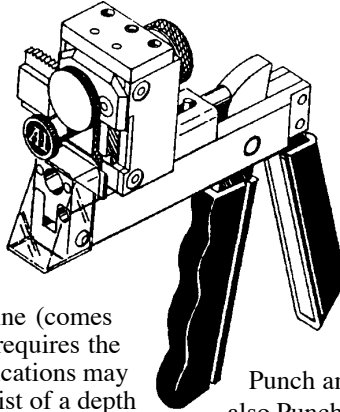

A-1

PAK-3S For Schlage

This machine is virtually the same as a PAK-3 with the exception that it is Fully equipped with the appropriate Depth Knob, Vise Assembly, and a Special Punch and Die for Code Cutting Schlage Keyways. No other attachments are necessary for Punching Schlage. Since the

Punch and Die are Interchangeable, those wishing to also Punch Automotive Keys with this machine may do so by purchasing the necessary Quickchange Kits and the Appropriate Punches and Dies.

Order #	Item #	Catalog Price
005-0250	PAK-3T	\$758.00

Order #	Item #	Catalog Price
005-0211	PAK-3S	\$900.00



PAK-A-PUNCH™ Quickchange Kit for PAK-3

Quickchange Kit includes required depth knob and vise assembly. 90° punch is included with machine. 90-T is optional and can be purchased separately.

Quickchange Kit

005-0260	PAK-F1	\$179.00
----------	--------	-----------------

Auto	Keyblank	Code Series	Kit	Years	Required Punch
Ford	H54, H55, H56, H60, H62	10 cut	PAK-F1	'84 1/2+	90°

PS2. Ignition Service Kit for GM 10-cut

With this set of tools the new GM ignitions may be readily picked & decoded.

Unlike Others, No Drilling Required. This set of tools will allow you to pick & decode GM 10-cut ignitions in minutes. Simply insert the special Tension Tool to apply sidebar pressure then pick the lock with your choice of four especially designed rocker picks. Once the lock is picked use the cylinder release tool to release the ignition from the column. After removal, the plug can be decoded quickly and effortlessly using the depth gauge supplied.

Includes ALL Tools Required:

Tension Tools, including style "B", 4 Rocker Picks with Leather Case, Depth Gauge, Cylinder Release Tool, and Service Manual by Carl Stramer.

Order #	Item #	Catalog Price
005-0002	PS2	\$295.00

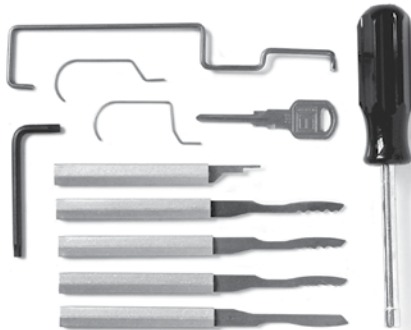

PS3. Service Kit for GM 10-cut in dash

The PS3 allows locksmiths to pick and decode GM 10-cut in dash ignitions in minutes. Using specialized tools, the bezel and the face cap are safely removed. A 3/32 access hole is drilled into the lock face (bit and extension included). Specialized tension tools, rocker picks, and release tools are then used to pick, release and then decode the ignition. The original face cap and bezel remain intact for reassembly. Without this service kit, the only alternative to servicing these locks involves disassembly of the dash.

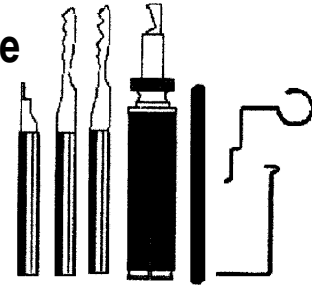

Order #	Item #	Price
005-0003	PS 3	\$295.00

LOCKSMITH TOOLS

PS100. Domestic Killer Automotive Pick Sets

Includes all tools necessary for picking GM 10 cut (column mounted and in-dash models), late model Chrysler & Ford 8-cut. Provides Turn-key systems.

Order #	Item #	Price
005-0100	PS100	\$879.00

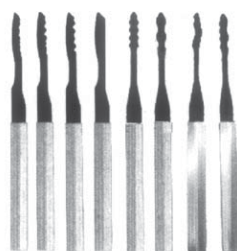

A-1

PS-4. Picking System for Ford 8-Cut

Similar to A-1's automotive picks for General Motors, these tools are designed to professionally pick Ford ignitions without damaging the locks or bezel. Includes a unique bezel removal tool, a jig with .070 drill bit for drilling the pilot hole, a specialized tension tool for disabling the side bar, and four rocker picks.

Order #	Item #	Price
005-0400	PS 4	\$249.00

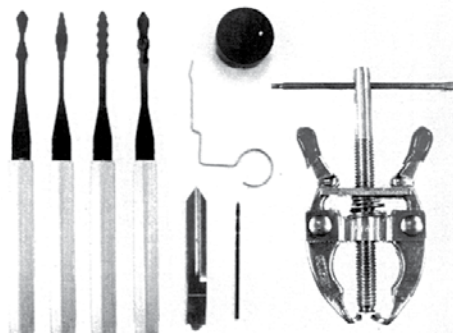

PS5. Chrysler Pick Sets

Includes all tools necessary for picking late model Chrysler. Use tools included to remove facecap, drill sidebar pilot, insert tension tool, pick, install new facecap. Also includes 6 replacement facecaps.

Order #	Item #	Price
005-1655	PS5	\$275.00

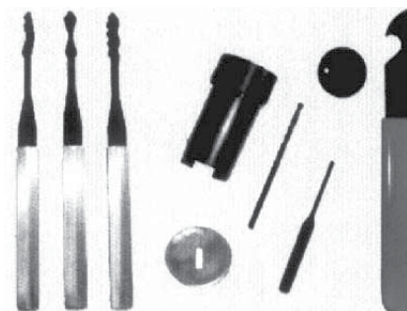

#47. Automotive Rocker Pick Sets

8 of A-1's favorite rocker picks. Use for domestic & foreign automotive applications.

Order #	Item #	Catalog Price
005-0047	# 47	\$99.00

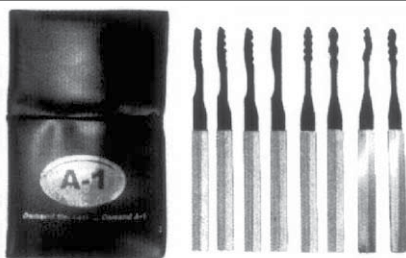

#54. Chrysler Replacement Face Caps

Replacement facecaps for late model Chrysler. Each package contains 10 facecaps.

Order #	Item #	Price
005-0054	# 54	\$37.90/pk

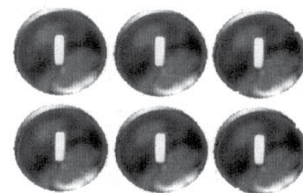

Car Opening Tools

RPS12. Tension Tools, Style "B"

In recent months, General Motors has introduced a new design of the GM 10-cut ignition. This new design, the TOP HAT, can be picked with A-1's product #PS2, however, an accessory Tension Tool "B" (#PRS12) is required. This tool is available to all owners of the #PS2 (PS2's manufactured after November 20, 1995 include this tension tool).

Order #	Item #	Price
005-0012	RPS 12 Style B	\$13.50

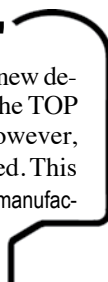

CO-2

Automotive

Vulcan Button Grabber



Unique rubber loop grabs and pulls buttons. Open up a whole new world with this simple and effective car opener. The rubber loop grabs and pulls most buttons even straight ones. Enters through door jam. Use strings for alignment.

Order #	Item #	Price
005-0440	CO2	\$31.90





TB1. The Block Decoding Tool for IC Core

A foolproof solution for determining Control Key Codes for IC systems. Drive the pin stacks into the Block where a pin tray keeps them separated and in order. Superior to shimming or disambly since all stacks stay in the original array. Includes ejector tool



005-0485	TB1	\$170.00
----------	-----	----------

TB3. Dumping Block

Gain the added confidence of knowing that your customers security is maintained by dumping used cores and leaving no trace of control Key Cores. A big time saver when re-keying, this tool allows you to dump and store the contents of dozens of cores. Includes ejector tool.

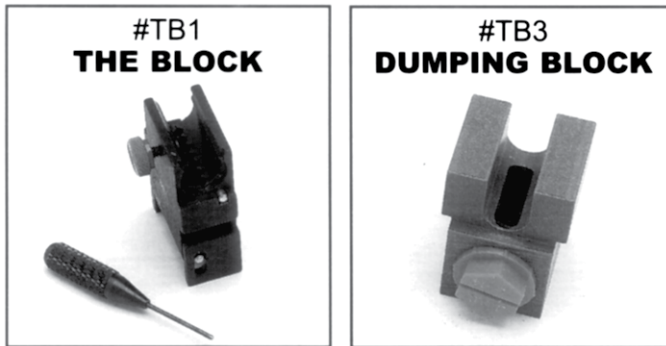

005-0490	TB3	\$110.00
----------	-----	----------

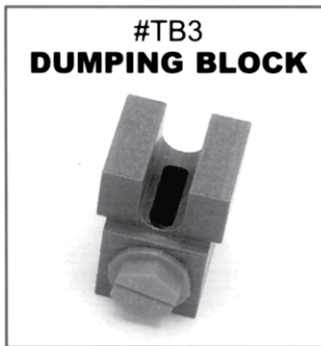

TB4. Duo Block

Now cap .140 or .150 spacing with a single, reversible capping block. Heavy Duty steel construction. Ideal for Capping "Best" style and High Security Peaks.

005-0495	TB4	\$145.00
----------	-----	----------

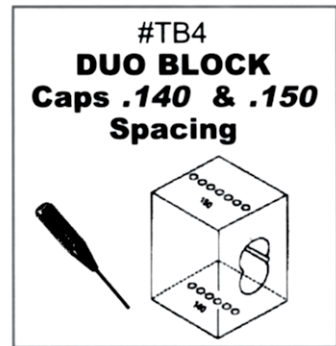

ICKT. Complete Service Kit for IC Core

Now you can purchase THE BLOCK, DUAL PURPOSE CAPPING BLOCK, and DUMPING BLOCK as a set at SUBSTANTIAL SAVINGS

005-0450	ICKT	\$420.00
----------	------	----------



Installation Tools

M100. Complete Mortise Lock & Crosshole Installation System

The only Mortiser offering a complete system. Use to mortise both the lock pocket and the faceplate pocket. The M100 is self-centering and accepts door thickness up to 2-1/2". Selective backset: 2-3/4", 2-1/2" & 2-3/4"

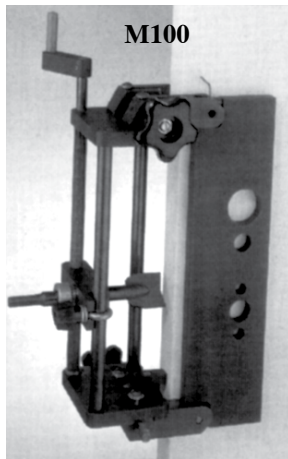

Order #	Item #	Cat.Price
005-0465	M100 Mortise System	\$1390.00

Side Plates not included.

Ejector Punches

TBIP. Originally designed for use the THE BLOCK, this single ejector punch is suitable for most any IC Core.

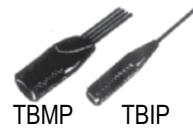

TBMP. A great time saver, eject cores with the 4-pronged punch. Suitable for manual use & with A-1's service equipment.

005-0500	TBIP	\$21.90
005-0505	TBMP	38.00

Side Plates.

Aircraft alloy and hard anodized for longevity & durability. Use for drilling cross holes & mounting holes. Sold in pairs.



Order #	Item #	Description	Catalog Price
005-0470	M4	Schlage "L" Mortise	\$329.90
005-0475	M6	Corbin/Russwin	353.90
005-0480	M7	Sargent	353.90

LOCKSMITH TOOLS

A-1



Installation Tools

Installation Innovation!



K100.Overhead Magnet Clamp The Kelly-Klump

Your third hand for installing overhead magnets

Order #	Item #	Catalog Price
005-0145	(U) K100	\$149.00



WT-1. Waffle Trays

Time proven design allows efficient organization of work space. Keeps pins, springs and plug neatly separated. Compact and stackable. Plated metal construction.

005-0170	WT-1	\$43.00
----------	------	----------------

Extractors

KP-1. Key Puller Set.

A high quality broken key extractor set fitted in a genuine leather case. One each: hook, standard, spiral & saw tooth.



005-0125	KP-1	Dealer Price: \$39.90
----------	------	------------------------------

IC Core Tools

Capping Press/Blocks

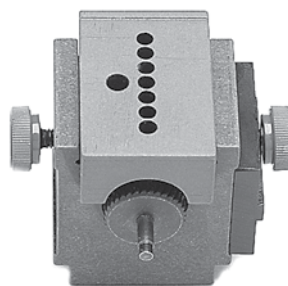

TB-2

TB2. Capping Block

Has two tops to cap Best, Eagle, Arrow & Falcon. It's a work station for interchangeable cores.

005-0154	TB-2	\$180.00
----------	------	-----------------

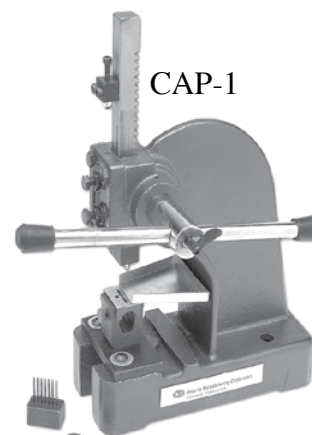

CAP-1

CAP-1. Capping Press Plus for IC Core

The only press which allows you to dump interchangeable cores in the same smooth manner as capping.

Caps Cores Manufactured by:

- Best • Arrow • Eagle • Others. Caps 6 or 7 pin.

005-0201	CAP-1	\$990.00
----------	-------	-----------------

QP. Quickpull

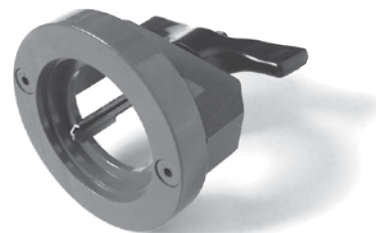

Cylinder Removal Tools for Kwikset & Dexter.

Snaps cylinders out from front of key-in-knob locksets in seconds. No damage to Kwikset 400 series. Dexter 3200 series will require replacement of retainer clips.

Order #	Item #	For	Catalog Price
005-0131	QP	Kwikset/Dexter	\$159.90
005-0615	QP-2	Schlage F Series	\$179.90

Hardened Replacement Steel Blades

for Quick Pull.

005-0235	QPBL	\$9.90
----------	------	---------------

AMERICAN

American Lock Co.

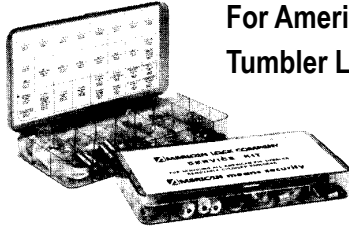

For American Rekeyable Pin
Tumbler Locks. **\$169.18**

Service Kits

Order #	Item #
425-0244	SK-8

CCL

**CCL
Disc Tumbler
Keying Kits**

KK125. Contents:

Service tumblers; Escutcheons; Master tumblers; Plug nuts; Cams; Stop cams; Lock retainers; Tumbler springs; Cylinder nuts; Lock washers; Pronged washers.

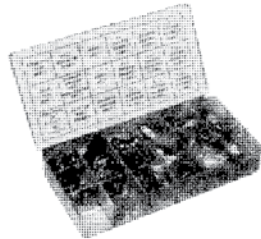

200-0664	COR-KK125	\$149.50
----------	-----------	-----------------

Century®
DRILL & TOOL CO., INC.



**Bi-Metal Hole
Saw Sets**

Variable Pitch Tooth, Cut
1-3/8" Deep Holes

4 Piece Metal Door Lockset

Four piece set includes 1" and 2-1/8" Bi-Metal Shark Tooth Hole Saws, thread adapter and arbor. For use on all metal doors.

Order #	Item #	Catalog Price
203-0001	05910	\$37.98



CHICAGO

Now Profits

Come in 10 New Colors! Price: \$4.88 pk/5

Key Handle Covers are made of a durable, strong plastic that press-fit any ACE II key. "User Friendly" because of the larger size that allows for better grip and overall control of the key. Easy "add-on" for extra profit on every sale.

Ace II Key Handle Covers

Order #	Item #	Color	Order #	Item #	Color
180-0510	D9645	Light Blue	180-0515	D9650	Blue
180-0511	D9646	Yellow	180-0516	D9651	Purple
180-0512	D9647	Orange	180-0517	D9652	(U) Tan
180-0513	D9648	Green	180-0518	D9654	Brown
180-0514	D9649	White	180-0519	D9653	Rust

Ace Tools

COMPX Chicago

Original Ace Quality Service Parts Now Together in a Convenient Kit!

Ace factory original parts to service your customers' needs are now available in a convenient kit.

Ace Tumbler Service Kits

Order #	Item #	Price
180-0500	CHI D9630	\$151.72

Pin Kits

With Original Chicago Lock Quality Parts:

Keyway frames, tumblers, springs, keys, washers, nuts & clips.



Order #	Item	Description	Price
180-9094	CHI-D9094	Single Bitted KIT	\$105.04

LOCKSMITH TOOLS

UN-DO-IT®



One Way Screw Removers.

Set of three UN-DO-IT sizes to fit all one-way screws

790-0800	DVS-800P	\$78.00/set
----------	----------	-------------

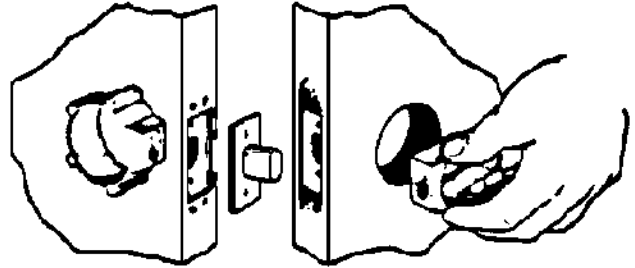

Ames Door & Lock Supports

Firmly anchor deadbolts & knob locks in hollow metal doors. 1-3/4"

245-0001	ODDA1346	\$9.00
----------	----------	--------



ESP. CJ-34 Multi-Tools

A unique tool with hundreds of different uses. Pull small springs - especially on mortise locks or knob tension springs on Schlage K locks or any lock where there's no room to use your fingers or pliers. Great to take tru-arc rings off of cylinders and taking the caps off key-in-knob cylinders and rim cylinders. Other uses include depressing the pin to remove Corbin and Russwin knobs and taking the wedge out of Schlage A80 cylinder locks. Particularly useful with the GMRT-88 Steering Column Compression Tool and GMRR-88 Retaining Ring tool.

As you work with the Multi-Tool, you'll discover uses we never even thought about. Developed by a professional locksmith. The handiest tool to come down the road in years.

Order #	Item #	Catalog Price
245-0005	CJ-34	\$15.00

Magnifying Tools

Magni-Focuser

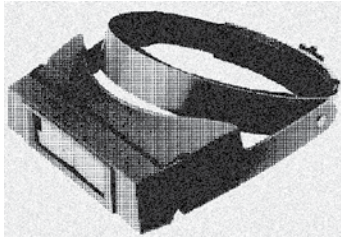

by Edroy Products

Adjustable comfort-design headband rugged construction. Auxiliary lens also swings up and down for additional magnification.

Regular Models:

Order #	Item #	Working Distance	Power	Price
255-0103	EDR-103	14"	1-3/4	\$45.00
255-0105	EDR-105	8"	2-1/4	45.00
255-0107	EDR-107	6"	2-3/4	45.00
255-0110	EDR-110	4"	3-1/2	47.40

Auxiliary Lens Models:

Order #	Item #	Working Distance	Distance with Aux. lens	Power with Aux. lens	Price
255-0113	EDR-113	14"	4"	4-1/4	47.00
255-0115	EDR-115	8"	3"	4-3/4	54.30
255-0117	EDR-117	6"	2"	5-1/4	47.00

FALCON

IC Core Tools
Interchangeable

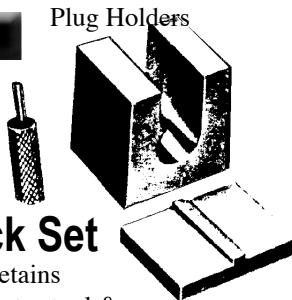

Core Pinning Block Set

Consists of pinning block that retains core while pinning, tamping/ejector tool & tapping plate for securing cover.

285-1141	FAL-A01411	\$143.56
----------	------------	-----------------

Interchangeable Core Keying Kits

A complete keying kit (A2 system) in a wood case. Includes , pins, wafers, spring covers, caps, key gauge, pinning block, pinning block set, tapping plate, ejector tool and instructions. (Replaces old 1410 kit.)

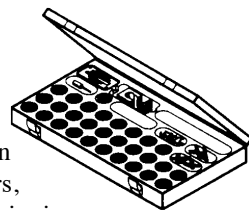

285-1410	FAL-1404	\$858.60
----------	----------	-----------------

Hinge Doctor

Hinge Adjustment Tools Save You Time & Money

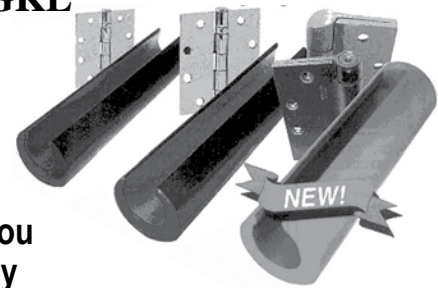

The Hinge Doctor Hinge Tools are specifically designed to adjust worn or improperly adjusted commercial and institutional hinges.

Adjusts Sagging Doors in Seconds.

With these Hinge Doctor Tools, you can adjust those distorted hinges and hinge mounting plates back to their original positions in less than one minute with no removal of the hinge from the door.

Best of all, these tools can be used over and over!

- HA1.** For 4-1/2" x 4-1/2" Hinges
- HA3.** For Ball Bearing and Large Hinges
- HA4.** For Prison and Institutional Hinges and Standard Spring Hinges

Order #	Item #	Catalog Price
335-0001	GKL HA1	\$100.00
335-0003	GKL HA3	99.90
335-0004	GKL HA4	179.90

• **GKL Hinge Screws: See Repair Parts.**



Residential and Small Format Hinge Adjuster Tool

Order #	Item #	Catalog Price
335-0002	GKL HA2	\$131.90

GKL Snap-In Bridge

Used to install Adams Rite MS locks.

Just push and turn with the spanner key (below), and its installed. Includes thin metal shims to bring the faceplate flush with the door's surface.

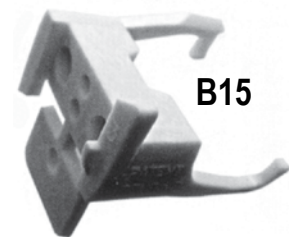

Order #	Item #	Catalog Price
335-0005	B15	\$11.00

GKL Spanner Key

Used to install hole filler discs & bridges

335-0006	SK1	\$20.00
----------	-----	----------------



LOCKSMITH TOOLS

Grobet File Company

Swiss Precision Round Files

Gradually tapered, cut and workable to the point.

Order #	Item #	Description	Handle	Price
340-0062	ZR62	6" Round #2 Cut	1 or 2	\$34.20
340-0064	ZR64	6" Round #4 Cut	1 or 2	40.00
340-0084	ZR84	8" Round #4 Cut	1	55.20



GROBET

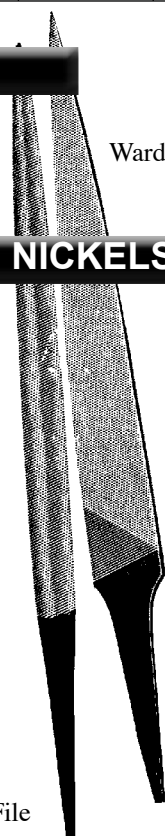

Warding File

NICKELSON

Pippin File



NIC-1, 2, 3, 4

File Handles:

Files:

Order #	Hole Opening		Price
625-0010	NIC-1	5/16"	\$3.58
625-0020	NIC-2	1/4"	3.12
625-0030	NIC-3	3/16"	2.80
625-0040	NIC-4	1/8"	2.42

Order #	Size & Type	Item #	Fits Handle	Price
625-0016	6" Pippin	NIC-PIP-6	NIC-1	\$80.60
625-0004	4" Warding	NIC-WBF-4	NIC-2	\$11.46
625-0006	6" Warding	NIC-WBF-6	NIC-1	\$11.92
625-0008	8" Warding	NIC-WBF-8	NIC-1	\$16.48

NEW

GENERAL®



RESCUE+ONE

Auto Emergency Tool + Flashlight

- Shatters automotive side windows for emergency escapes.
- High-visibility red flashing emergency light.
- Magnets hold the tool to the vehicle.
- Bright white LED flashlight helps you see at night.
- Safety blade cuts seat belts.
- Includes: 3 "AAA" batteries.

Individually carded or 6 piece Display Unit

Order #	Item #	Catalog Price
325-0001	7902	\$17.78
325-0006	7902D Counter Display	95.98



HPC Code Cards
for HPC 1200CM MACHINE
Foreign Auto Code Cards

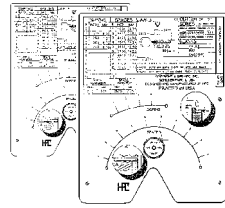

Japan "XF" Cards \$29.90 Each

Order #	Description
190-1068	CF68 Mazda 10 cut. 1989+ Mazda MPV van, MX5 Miata, 323, X188, X200, Ford world markets Protetege 323. Various Fords X201 Code series: 10100 to 12099.
190-1073	CF73 HONDA, ACURA. Double-sided. All locks 1982 up. 1001-2700 & 3001-4481 series. X128, X129, X130, X164.
190-1074	CF74 HONDA, 1988-up. Latest 8 disc CIVIC, CRX etc. 5001-8442 series. X182. Use CW-47MC cutter.
190-1087	(U) CF87 TOYOTA, DBL-sided "8-wafer". '86 up Celica lift back, '87 up Tercel. S0001-2878 series. TR39. X151.
190-1088	CF 88 TOYOTA, MITSU, GEO, etc. Use CW47MC cutter. Tay X174, X176, X184, X185, X192.
190-1089	CF89 Geo Tracker 1989+ Geo Tracker & Suzuki Sidekick. X180, X186 Suzuki Sidekick 1990+ Isuzu - pickup truck, Rodeo models, X198 and Isuzu U.S. produced only. Code series: 18100 to 19299.D4001-6000.

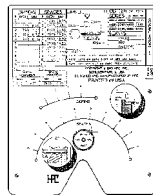

Domestic "X" Cards \$29.90 Each

190-4006	CX6 EMHART, Corbin, Russwin conventional Stytem 70.
190-4014	CX14 STEEL CASE, (Chicago), Small pin.
190-4032	CX32 HUDSON, Single-sided disc tumbler
190-4059	(U) CX59 CHRYSLER, Double-sided 1989 & up Spirit & Acclaim. All domestic in 1990. F,G 0001-1394 series. Mstr,valet. P1789.
190-4060	CX60 1993 Chrysler, Jeep, Eagle. For J0001-3580 codes. P1793/Y155 Keyway. Service manual & codes included.

Miscellaneous "CF Cards \$29.90 ea

190-1205	(u) CF205 GM PONTIAC LEMANS (S) 88+
----------	--



HPC Code Cards for 1200CM Key Machine
\$29.90 Each

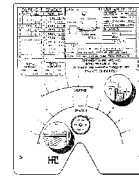

Order #	Item	For:
360-2213	C13	(U) Corbin Pre-System 70 X-Class
360-2214	CX14	(U) Corbin Pre-System 70 Z-Class
360-2005	CMC81	(U) Yamaha Cycle '77-'86
360-2221	CF302	(U) Hyundai 8 cut (S,T Series)
360-2222	CF303	(U) Ford Aspire (Kia) 10 cut B Series
190-0031	C31X	Standard Kwikset Titan

Schlage Everest Code Card

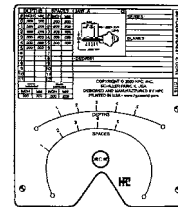

HPC's Card C116 is designed to cut the new Schlage Everest Small Format Interchangeable Core Keys. Schlage Standard Cylinder can use the Large Pin card, C45. For use with all HPC 1200CMB Machines.

Order #	Item #	Catalog Price
360-1116	C116	\$29.90

HPC Chrysler 8-Cut Code Cards

Now available for both 1200CM Series Code Machines and the 1200PCH Punch Machines

The new Chrysler 8-Cut key will soon be in all Chrysler, Plymouth, Dodge, Jeep, and Eagle vehicles. **\$29.90 Each**

Order #	Item #	For
360-2002	(U) CARD-PX102	1200 PCH
360-2006	(U) CARD-PF304	1200 PCH
	Nissan Pathfinder '96+	

(U) Available while supplies last

LOCKSMITH TOOLS



CO-10. The Slim Jim

Tool does not enter inside car. Opens door by "feel" not sight. For GM, Ford & Chrysler cars. Clock-spring steel, hand finished.

360-0057	HPC CO-10	\$17.20
----------	-----------	---------



CO-11. Super Jim

Opens most GM, Ford & AMC car doors. Chrysler products after '74, have locking mechanism protected by a sheet metal, box-shaped lock cylinder clip and cannot be opened with this tool. Made wider and thicker than CO-10, and is bright nickel plated.

360-0058	HPC CO-11	\$17.90
----------	-----------	---------

CO-18. The Sir James

Deluxe version of the Super-Jim



with permanently stamped depth grid on blade for marking steps. Leather covered handle secures pad of paper to record opening information by vehicle, model and year.

360-0059	HPC CO-18	\$35.00
----------	-----------	---------

Peg Leg Jim

1980 GM with cover over cylinder & linkage, works on older cars also.

360-0060	HPC CO-20	\$26.90
----------	-----------	---------

CO-22. The Jim Dandy

GM models other than "X", great on most Japanese cars & trucks.

360-0062	HPC CO-22	\$24.90
----------	-----------	---------

CO-24. The Big Jim

Specialty is "X" type GMs, but opens almost everything Slim Jim will.

360-0063	HPC CO-24	\$21.90
----------	-----------	---------

CO-52

Opens almost any auto with vertical linkage. Used simultaneously with the Super Jim (CO-11) or Slim Jim (CO-10). Comes with graphic, understandable instructions. Most thru handle Fords.

360-1206	HPC- CO-52	\$31.60
----------	------------	---------

The Super "J"

HPC Car Opening Tools (All have complete instructions).



Beretta Entry

Tool CO-59

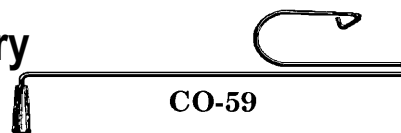

Designed to unlock either door of the 1988 Chevrolet Beretta in less than 60 seconds with no damage to any part of the auto.

360-1214	(U) CO-59	\$37.90
----------	-----------	---------

Caddy Killer™ CO-60

Operates like CO-59, but has a few dimensional modifications. Width of arc has been decreased to accommodate cars with narrower door panels, length of opening arm has been increased in proportion to amount of window clearance inside window cavity. Works on Sedan DeVille, Coupe DeVille & Eldorado, also Buick Riviera & Olds Toronado.

360-1260	HPC- CO-60	\$35.50
----------	------------	---------

CO-61

Long Killer

Longest possible.

Based on CO-59 & CO-60. 1.5" longer. Opens '88 & '89 Buick Regal, Pontiac Grand Prix, Chevy Astro, etc....

360-1261	HPC- CO-61	\$35.50
----------	------------	---------

CO-68.

"Over Hook"

Designed to hook onto horizontal control rods inside car door, including some that might be located behind window, etc. Tool can go down, then back up, behind window to hook onto a control rod. Then twisted to make it bind the rod. While binding rod, it is pivoted to move the control rod. Contact point for some horizontal control rods may be where rod is bent so that its at an angle, not horizontal. Primarily used on GM cars, can also be used on other vehicles, including several foreign cars.

Order #	Item #	Price
360-1273	HPC CO-68	\$30.20

CO-70. "Super Killer"

Extra length and greater strength, can be used to open a wide variety of vehicles. (Almost all of the vehicles that the CO-59, 60 & 61 can open plus several that are beyond the reach of these tools.) By inserting this tool at an angle, it can get under the deepest windows and then go over the highest and widest inside car door padding to reach the inside door lock indicators. Strength is such that it can be used to push, pull or lift lock indicators, even those operated by power door locks. Smooth, rounded surfaces eliminates any risk of scratching the car. Opens many vehicles, especially GMs.



Order #	Item #	Price
360-1274	HPC CO-70	\$36.50

CO-71. Stretch Double "L"

Upward hook on one leg and outward hook on the opposite leg so it can easily grab and bind vertical linkages from above or below. Both hooks are laminated with a slip resistant coating. It is able to lift, lower or rotate bell cranks and lazy pawls. It is also able to reach around many shields. Works best on doors with thick door panels. It can be used on all GM, Ford Lincoln Mercury, Mitsubishi, Mazda, Honda, Hyundai, Chrysler/Plymouth, Toyota, Nissan, BMW, Jaguar and many more!

360-1371	HPC CO-71	\$27.50
----------	-----------	----------------

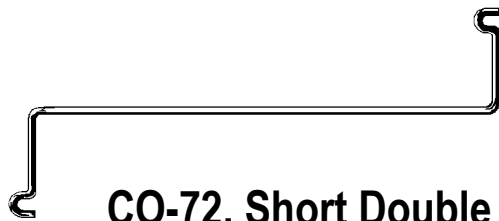

CO-72. Short Double "L"

Upward hook on one leg and outward hook on the opposite leg so it can easily grab and bind vertical linkages from above or below. Both hooks laminated with a slip resistant coating. Able to lift, lower or rotate bell cranks and lazy pawls. Also able to reach around many shields. Works best on doors with narrow door panels. Can be used on all GM, Ford Lincoln Mercury, Mitsubishi, Mazda, Honda, Hyundai, Chrysler/Plymouth, Toyota, Nissan, BMW, Jaguar and more!

360-1272	HPC CO-72	\$26.00
----------	-----------	----------------

CO-73. Lasso™

The Lasso™ tool is for vehicle entry when the lock button is visible. It is made of high quality "poly-flexo" material with a durable string. The tool allows you to wrap the string around the lock button and lift up to unlock the door.

360-1276	HPC CO-73	\$16.50
----------	-----------	----------------

Clutch Car Openers

Unlike any others on market. When handle of tool is pulled apart, hook at end of tool is pulled inward, causing tool to grip or bind linkage rod. Helps simplify "in-the-door" method of vehicle entry.



CO-75

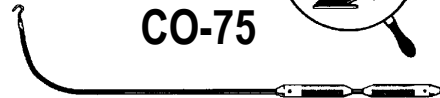

CO-76



Two different styles are available: The Vertical Clutch™ for vehicles with vertical linkage and the Horizontal Clutch™ for vehicles with horizontal linkage.

Price:
\$71.90
Each

Order #	Item #	Description
360-1275	HPC CO-75	Horizontal Clutch
360-1376	HPC CO-76	Vertical Clutch



CO-79. Instant Explorer Tool

Opens a wide variety of vehicles, but was specially designed to open Ford Explorers in seconds! The CO-79 easily slides under the handle and grips the vertical rod under the button. Then, with a slight push on the foam handle the button pops up. Tool is a must for locksmiths in need of quick entry into the most popular sport-utility vehicles on the road today.

Order #	Item #	Price
360-1379	HPC CO-79	\$29.30

LOCKSMITH TOOLS

CO-83. The Fishing Pole

**Shift and Shape!
Twist and Turn! Flip &
Flex! Grip & Grab!**

The Fishing Pole (CO-83) is HPC's most flexible tool ever. At 7 feet (2.13 meters) long, the Fishing Pole easily reaches across almost any car. Its bendable body can be configured to any shape. When the handles are separated, the working end curves and flexes up to a 90-degree angle - that you can twist in any direction. Comes with three screw on tips including a bendable Posi-Form Wire Loop, a Super-Pull Catch, and a large Sure-Grip Hook. If you want to wiggle and worm your way through quicker car opening, us a **Fishing Pole!**

Order #	Item #	Price
360-1283	HPC CO-83	\$129.00

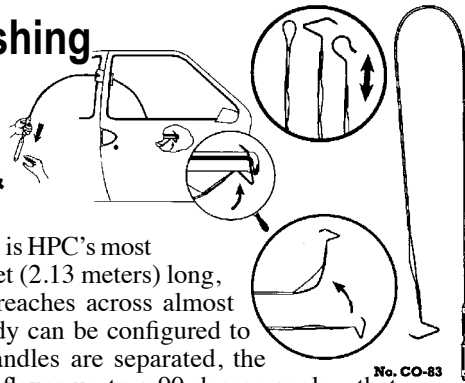

Car Opening Tools

HPC

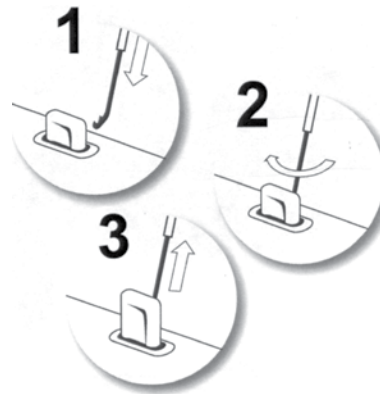

CO-84 Flexi-Jim

Helps you to maneuver around shields and window rails allowing you to reach the right vertical rods and unlock your door. The spring steel laminated body holds stiff while the super flexible end bends into position as you pull up on the cord. Switching the position of the cord adds a gentle twist to the tool for hard to reach rods.

Order #	Item #	Cat. Price
360-0065	CO-84	\$59.90

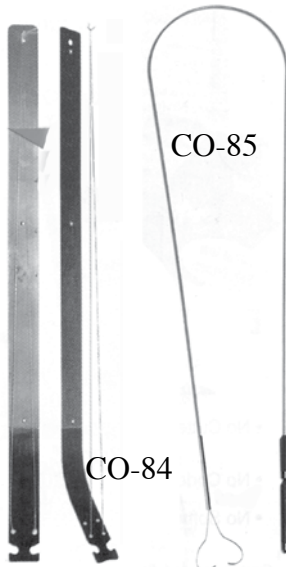

CO-86: Fish Hook

The new Fish Hook tool is for vehicle entry when the lock button is visible. Used with an HPC Wedge, the tool enters the auto interior, engages the button and with a simple twist, raises the button. This unique design features a long reach memory-flex rod for bending to the required shape.

METHODS OF ENTRY:

* Through Car * Under Button Style

CO-86 OPENS:

CHEVY	CHRYSLER	DAIHATSU
DODGE	FORD	GEO
GMC	HONDA	INFINITI
ISUZU	LEXUS	LINCOLN
MERCEDES	MERCURY	MITSUBISHI
NISSAN	OLDSMOBILE	PORSCHE
ROVER	SAAB	SUBARU
SUZUKI	TOYOTA	
VOLKSWAGEN		

Plus, many more!

Order #	Item #	Catalog Price
360-1265	CO-86	\$69.90

CO-85 Twin Hooks

Reaching across vehicles and grabbing door handles has never been easier. The new HPC Twin Hooks has a double-hook end that opens and closes with a simple push and pull of the tool handle. The two hooks overlap each other as they close giving twice the strength and a solid hold. Twin Hooks securely grabs onto door handles from as far as 7 feet away.

Order #	Item #	Catalog Price
360-0066	CO-85	\$135.50



HPC AUTO KILLER KITS Car Opening Tools

Button Clutch™ Killer Kit No. AKK-BC

The Button Clutch™ is a money-saving point-of-purchase packaged kit that Includes:

- Button Clutch™ No. CO-87
- Ultimate Auto Wedge No. AW-38
- AutoSleeve™ No. AS-1

Available Separately

Button Clutch™ No. CO-87

Similar to HPC's patented Vertical and Horizontal Clutch™ Tools and Super Snare, this compact action tool will grab lock buttons and not let go! Combined with an HPC Air Wedge®, this hybrid tool will make your next auto opening quick and effortless!

Order #	Item #	Catalog Price
360-0320	AKK-BC	\$71.98
360-0315	CO-87	\$59.98



Skinny Flipper™ Killer Kit No. AKK-SF

The Skinny Flipper™ Killer Kit is a low-cost point-of-purchase packaged kit that includes:

- Skinny Flipper™ No. CO-89
- AutoSleeve™ No. AS-1

Available Separately

Skinny Flipper™ No. CO-89

The Skinny Flipper™ is made of superbouncy spring steel and the laminated body allows you to manipulate the working end from outside of the car. You'll flip when you use this new HPC solution to tight door seams!

Order #	Item #	Catalog Price
360-0340	AKK-SF	\$75.98
360-0335	CO-89	67.98



Skinny Twister™ Killer Kit No. AKK-ST

The Skinny Twister™ Killer Kit is an economically priced point-of-purchase packaged kit that Includes:

- Skinny Twister™ No. CO-88
- AutoSleeve™ No. AS-1

Available Separately

Skinny Twister™ No. CO-88

When faced with vehicles that won't wedge open, flip to the new twist in car opening. The thinnest through-car tools available, they slide between windows and weather-stripping where rod tools just can't fit. The Skinny Twister™ has two different working ends and can be bent into almost any configuration. It can twist and turn as it squeezes inside the vehicle. A quick pull of the cord helps you locate the latch and open more cars.

Order #	Item #	Catalog Price
360-0330	AKK-ST	\$39.98
360-0325	CO-88	31.98



Gold Finger Killer Kit No. AKK-GF

The Gold Finger Killer Kit is a sharp priced point-of-purchase packaged kit that includes:

- Gold Finger No. CO-90
- Original HPC Air Wedge® No. AW-100
- AutoSleeve™ No. AS-11

Available Separately

Gold Finger No. CO-90

5-foot long bendable car opening tool has two special working ends. The hook end is designed to mimic your finger action pulling levers and flipping rockers. The opposing end is perfect for grabbing switches that must be pushed. Bright yellow ends are easy to see in dark interiors and the super strong steel body will outlast similar tools.

Order #	Item #	Catalog Price
360-0355	AKK-GF	\$79.98
360-0350	CO-90	\$39.98



LOCKSMITH TOOLS

HPC AUTO KILLER KITS Car Opening Tools

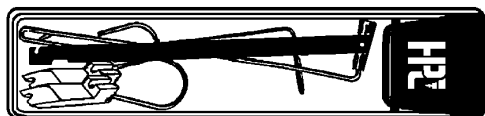

Starter Killer Kit

Includes the Super Jim (CO-11) for vertical rods, Jim Dandy (CO-22) for under button, Horizontal Hook (CO-39) for horizontal linkages, the Stretch Killer (CO-61) for under and over style openings, and 3/8" auto wedges (AW-38). All of these tools come complete in a clear view plastic case.

360-2301	HPC AKK-55	\$99.00
----------	------------	---------

Pro Killer Kit

Includes all the tools in the Starter Kit, plus the Safari Joe (CO-62) for horizontal offset linkage, the Collapsible Opener (CO-6) for through the car, Mercedes Benz Opener (CO-21) for vacuum locks, Flex-A-Light (FAL-15) and 3/4 auto wedges (AW-34). Complete in a clear-view plastic case.

360-2302	HPC AKK-66	\$277.50
----------	------------	----------



Quick-Grip Swivel Mirrors No. SM-100

Reflect on this new tool! This polycarbonate mirror is practically unbreakable! It sticks on the opposite window of the vehicle door you are trying to open. It reflects the interior so that you can easily see the levers, buttons and handles that you are trying to reach. The new HPC Quick-Grip Swivel Mirror bends and spins to any angle needed.



Order #	Item #	Catalog Price
360-0365	SM-100	\$99.98

Classic Killer Kit

Includes everything in the Deluxe Killer Kit, plus the HPC classics including the Ultra Jim (CO-55), the Flexible Peg Leg (CO-56), the J-Flex (CO-57), the original Slim Jim (CO-10), the Super Killer (CO-70), the Caddy Killer (CO-60), and the

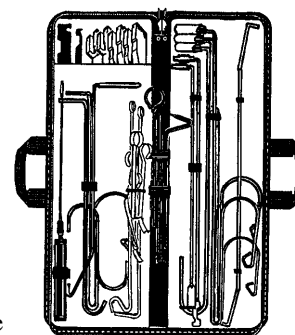

Beretta Opener (CO-59). Complete in a deluxe highly durable custom-made carrying case.

360-2304	HPC AKK-88	\$750.00
----------	------------	----------

Ultimate Killer Kit

Includes everything in the Classic above, plus the Over Hook (CO-68), Reverse Over Hook (CO-67), Stretch Double "L" (CO-71), Short Double "L" (CO-72), Lasso (CO-73), Trip Tool (CO-74), and Novice Pick Set (PIP-13). Complete in a deluxe highly durable custom made carrying case.

360-2306	HPC AKK-99	\$840.00
----------	------------	----------

HPC's Jam-Packed Thru Car Killer Kit

Contains All of HPC's Thru Car Opening Tools.

AKK-TC:

- Collapsible Opener (CO-6)
- 5 Foot Super Snare (CO-78)
- Switch Stick (CO-80)
- AutoSleeve (AS-1)
- Original Air Wedge (AW99)
- Power Wedge (PW-100)

Plus:

- Thru Car Clutch, • Super Thru Car Clutch,
- Interactive Car Opening Authority • Fishing Pole,
- How-To-Master Car Opening for the Security Specialist.

Protect your customer's vehicle by using the right tool for the job!

Order #	Item #	Catalog Price
360-0030	AKK-JPTC	\$599.90

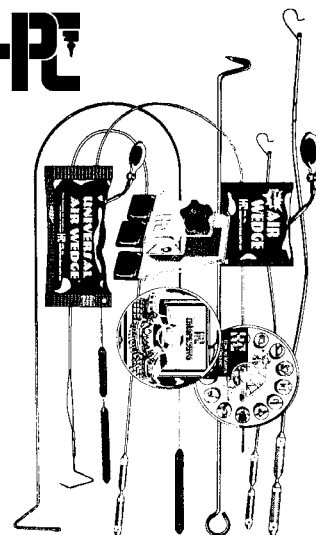

Wedges



Universal Air Wedge®

Slides between the vehicle door and the weather stripping on the door frame. Then the pump is squeezed, inflating the Air Wedge and separating the vehicle door from the frame providing more than ample room to insert a car opening tool. The increased width of the Universal Air Wedge gives you a larger gripping area for inserting the wedge into the top corner of tighter fitting doors. Equipped with a release valve.

- Thickness, not inflated: .08" (2mm)
- Thickness, maximum inflated: 2.75" (7cm)
- Dimensions: 11" (28cm) x 5.125" (13cm)

Order #	Item #	Catalog Price
360-1210	HPC AW-100	\$68.50

Auto Wedges

Designed for smooth, safe insertion without risk of dropping into door cavity. Because taper ends before stop, no risk of it popping back out. Features "Illumination Hole", allowing most flex lights to pass through.

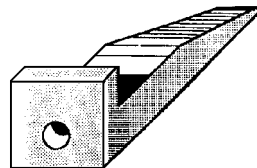

Order #	Item #	Price
360-1338	HPC-AW-38 (3/8")	\$20.90
360-1334	HPC-AW-34 (3/4")	20.90

PW-100. Power Wedge

An advanced vehicle opening aid for security professionals.

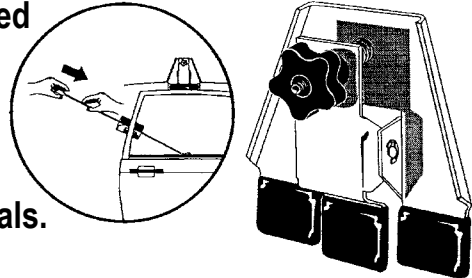

A revolutionary auto entry device designed to aid in opening even the most difficult vehicles. A spring loaded compound lever that safely spreads a vehicle door away from the body allowing for the easy entry of a "Through the Car" opening tool. The Power Wedge slides into the opening between the vehicle's door and frame at the top of the door. Rubber coated tips protect the vehicle, and the adjustment knob allows you to control the width of the door opening. Simply turn knob clockwise and watch as the door slowly opens giving you room to use a car opening tool. Made from 14 gauge steel. **Just slide it in, crank it open, and insert your tool!**

Order #	Item #	Price
360-0305	HPC PW-100	\$99.00



AW-99. The Air Wedge

Unlike anything else on the market. The Air Wedge slides between the vehicle door and the weather stripping on the door frame. Then the pump is squeezed, inflating the Air Wedge and separating the vehicle door from the frame. This provides more than ample room to insert a car opening tool. The Air Wedge is made of a sturdy vinyl and equipped with a release valve.

Order #	Item#	Price
360-1207	HPC AW-99	\$57.90

LOCKSMITH TOOLS



Clip Removal Tools

For door handle & window cranks. (GM, Ford & AMC). Removes hard to reach retaining clips without damage.

360-0016	HPC AST-3	\$18.50
----------	-----------	---------

Clip removal tool for door trim. Removes the trim pads without tearing out the nylon retainer clips.

360-0017	HPC AST-4	\$35.70
----------	-----------	---------

Automotive door panel clip removal tool. The new offset design with longer handle allows you to reach clips toward the center of the panel.

360-1425	HPC AST-5	\$36.90
----------	-----------	---------

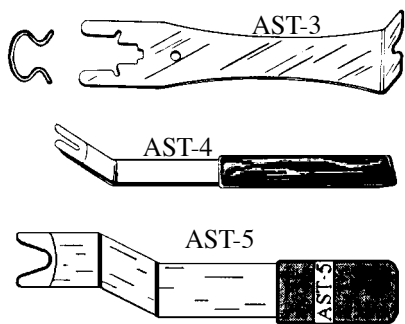

Auto Lock Pliers

ALCP-10. Grips like a bulldog! Remove auto lock face caps in seconds.

360-0011	ALCP-10	\$63.30
----------	---------	---------

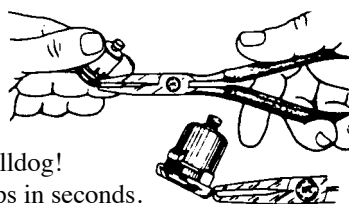

KIKR-100 Key-in-Knob Removers

Occasionally locksmiths need to service a locked door that they cannot pick open. Based on the HPC Lever Handle Remover, the new Key-in-Knob Remover removes ball, tulip and standard style knobs for servicing without damaging the lockset! Perfect when picking is not an option! A must-have tool for all security professionals.

Order #	Item #	Catalog Price
360-0102	KIKR-100	\$398.00



Lock Plate Compressors

Tilt & Telescopic steering columns. Specially designed lockplate compressor for tilt & telescopic columns used on GM. Assures an easier access to ignition lock retainer after steering wheel is removed.

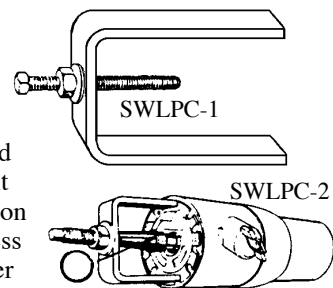

360-0420	SWLPC-2	\$37.50
----------	---------	---------

HPC Steering Column Lock Plate Compression Kit. SWLPC-1

Complete kit, includes both standard & metric threaded screws.

360-0418	SWLPC-1	\$156.50
----------	---------	----------

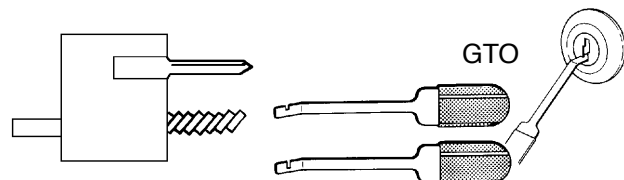

ITF-4. Ignition Drill Template for Ford

Allows swift, precise removal of side-bar so that replacement can be done almost immediately. Uses keyblank as a guide.

360-1280	HPC ITF-4	\$81.50
----------	-----------	---------

GTO. Gateway Tools

GTO. 2-piece set, holds dust cover on auto door locks, exposing entire keyway. Two sizes cover all major domestic as well as many imports.

360-1330	HPC GTO	\$15.00
----------	---------	---------

Lever Handle Removers

Lets You Quickly Remove Locked Lever Handles When Picking is Not an Option.

Designed to quickly remove locked lever handles for servicing, it is ideal when picking the lock is not an option. To use, place the tool's specially designed hub over the lever, and using an easy procedure of manipulating a few bolts and screws, you are able to remove the handle, open the door, and service the lock. Simple to use with amazing results.

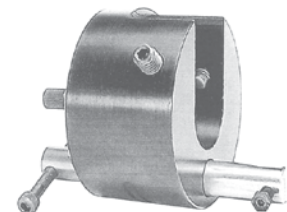

Order #	Item #	Price
360-0100	LHR-100	\$430.00

A simple concept that is a great ideal! Patent Pending



Books & Manuals

Car Opening Authority

Opening information on over 650 vehicles all in just one binder.

A multifaceted user-friendly manual that serves not only as a reference book, but also as an educational aid and opening index. It clearly depicts and explains all of the different techniques of the 13 styles of car opening. It shows you how to open virtually every vehicle for the past 15 years, including ALL of the current cars, vans, and SUV's found in the USA and Canada, as well as many from around the world.

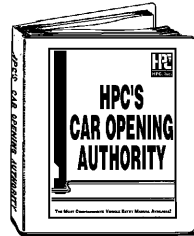

Concise, compact, fully illustrated and easily updatable.

For the beginner, it will show you that one or more of the 13 opening methods can open many vehicles. Once you learn how to perform each of these opening methods, you will learn how to identify which techniques to apply to which vehicles.

For the experienced car opening professional, who knows the value of space in a work vehicle, this is the ideal book.

Models Index. Lists more than 650 vehicle models by year for the past 15 years. This spreadsheet formatted index points you to one or more opening techniques for each vehicle and alerts you to any vehicle-specific information.

Opening Methods Pages. The 13 Opening Styles and techniques use precise illustrations to take you through all of the different opening methods. Each technique gives a list of recommended and optional tools, as well as any style-specific precautions.

Tools Page. This section gives a pictorial listing and description of ALL of HPC's car opening tools.

Plus. In an effort to keep you current with the latest car opening issues, sections on Side Impact Airbags and Ignition Anti-Theft Systems, as well as a list of the car manufacturers' road side assistance telephone numbers are included.

Order #	Item #	Catalog Price
360-1277	HPC COA-22	\$378.00

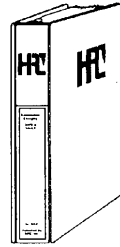

Safe Combination Changing

HPC-SCC. A collection of original direction sheets that explain how to operate and change combinations, written by the safe lock manufacturers. It contains 85 pages and hundreds of illustrations and diagrams. Combo changing info for Diebold, Eagle, HHM, S & G, Yale and York safe locks manufactured during the last 75 years. This

book helps the user get the best results in the shortest possible time by using the proper procedures.

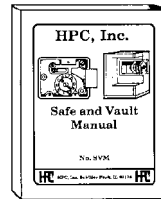

Safe & Vault Manuals

HPC-SVM. The "Safe Man's Bible"

Whether you are new to safe work or just interested in broadening your knowledge of safe locks, you will find this book contains valuable information covering a wide variety of safe lock topics. It contains

over 250 illustrations, 1000 factory try-out combinations and a section on original factory methods of safe & vault combination changing.

This book includes: Hand Changing; Key Changing; Drilling Locations; Lock Servicing; Internal Drawings; and Time Lock Operation.

The Art of Manipulation

HPC-TOAM-2.

Open Combination Locks

Without Drilling, Burning, or Forcing.

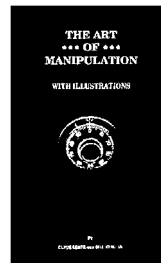

Written for locksmiths and safe professionals in order to improve their technique and knowledge of opening and servicing safes. This manual will familiarize you with why manipulation is possible and how it is accomplished.

Illustrates the step-by-step procedures needed to manipulate lever type fence locks. Also explains the methods used in the rotary fence gear driven, rotary fence spring loaded, straight in tailpiece, bottom drop, and off-set gear driven type locks.

Sale restricted to established Safe Men and Locksmiths.

360-0569	SCC	Safe Combo Changing	\$74.00
360-0571	SVM	Safe & Vault Manual	114.00
360-0572	TOAM-2	Art of Manipulation	242.00

LOCKSMITH TOOLS

Books & Manuals

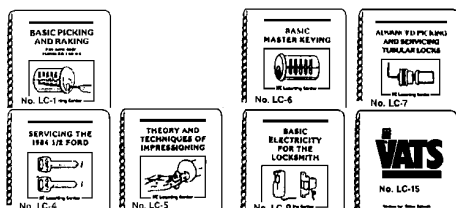

Learning Center Library Reference Collection

A series of technical manuals designed with the security professional in mind. All manuals are written clearly and feature meticulously detailed exploded view drawings. The spiral binding allow the manual to be opened flat, compliment the convenient 6" x 9" format.

LC-1. BASIC PICKING.

Describes in detail the theories and techniques for picking standard pin and wafer tumbler locks. All the necessary tools - such as picks and tension wrenches - are listed and fully illustrated for convenient cross-reference.

LC-5. BASIC IMPRESSIONING

Explains the essential theories and methods for making a key by impressioning. The proper technique for blank preparation (spacing), obtaining marks and the ability to recognize marks are covered in detail.

LC-6. BASIC MASTER KEYING

Introduces the locksmith to the theories and principles associated with master keying. Includes such techniques and 1 and 2 Step Progression, Incidental Master Keys, etc. Fully explained and illustrated.

LC-8. BASIC ELECTRICITY for LOCKSMITHS

Describes fundamental electrical theory. Describes procedures which are necessary to determine the compatibility of electrical strikes, transformers, etc., through the use of Ohm's law. Electrical components and their corresponding symbols, as they are represented in schematic diagrams, are also discussed.

Order #	Item #	Cat. Price	Description
360-1230	LC-1	\$59.90	Basic Picking
360-1240	LC-5	75.90	Basic Impressioning
360-1245	LC-6	119.90	Basic Master Keying
360-1250	LC-8	69.00	Basic Electricity for Locksm

SEE: Software section for CD versions.

Router Bits

HPC RD-1. Fits any electric drill. Cuts own starting hole & any shape in any direction tool is moved. Cuts wood, plastics, non-ferrous metals. Saws, Drills, Routes & Files.

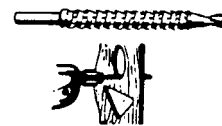

360-0312	RD-1	\$24.80
----------	------	---------

Key File Set

KFS-6. Set of 6 Swiss Pattern Files. Round tapered, warding tapered, rectangular straight, 3 sq. tapered, square tapered, half-round tapered.

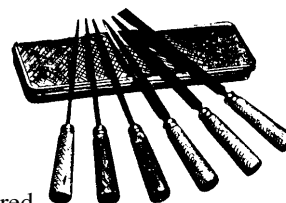

360-0218	KFS-6	\$59.00
----------	-------	---------

Case & #4 Cut Impression Files

360-0182	HPC IFH-4	\$73.00
----------	-----------	---------

Safe Tools

NST-6. Set of 6 tools to open most popular safe locks after burglary has been attempted. Entering thru existing hole, they not only align wheel pack, but also hold relocker aside so that safe can be opened quickly & easily.

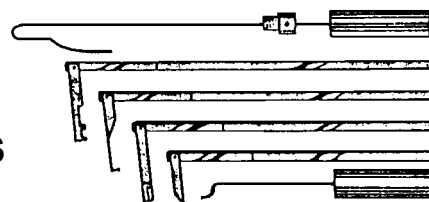

360-1222	NST-6	\$223.00
----------	-------	----------

Safe Drills

The SHPD-6 and SHPD-8 are economical bits designed for one time use on steel hardened to Rockwell C-40. The SHPD-12 and SHPD-14 are premium quality tungsten tip drill bits designed for multiple use on steel hardened to Rockwell C-40 up to C-64.

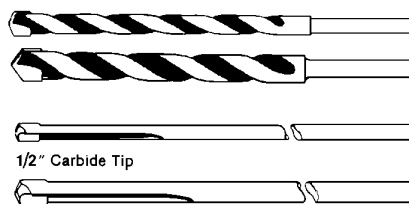

Order #	Item #	Hole size	Length	Tip	Price
360-0342	SHPD-6	3/8"	6"	Carbide	\$20.00
360-0343	SHPD-8	1/2"	6"	Carbide	23.00
360-0344	SHPD-12	1/4"	8"	Tungsten	159.90
360-0345	SHPD-14	3/8"	8"	Tungsten	174.00

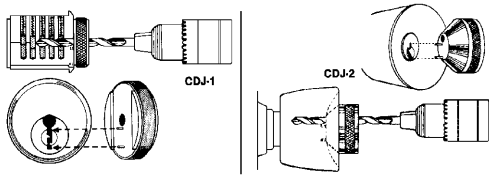
HPC

HPC Cylinder Drill Jigs

Cylinder Drill Jig & Drill Bit for a flat face cylinder.

360-0047	HPC-CDJ-1	\$34.50
----------	-----------	---------

HPC-CDJ-2. Cylinder Drill Jig & Drill Bit for recessed Tulip design types.

360-0048	HPC-CDJ-2	\$34.50
----------	-----------	---------

Center Key (Top to bottom)

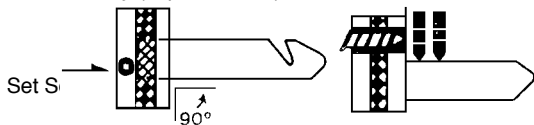

Cylinder Drilling Jig for Removable Core Locks

Ingenious device is absolutely essential for professional locksmiths who service removable core locks.

360-1430	HPC CDJ-3	\$53.00
----------	-----------	---------

Nose and Door Pullers for Safe Deposit Boxes

Heavy wrought & bar steel set expertly machined & finished to effectively pull out a lock core. Turn screw into center of core's keyway to act as an anchor; slip spacer block into place & tighten by turning knurled knob slowly clockwise until entire core is drawn out. Use guard key & disengage bolt. If door does not open, then use DP-7B (shown below, DP-7B set includes the NP-4B set). Can also be used towards removing plug from a padlock.

360-0258	HPC-NP-4B	\$204.00
----------	-----------	----------

DP-7B Door Puller Set.

Complete door puller set in position & ready to pull out the safe deposit box door. After lock core has been pulled and use of the guard key has not opened the door, then it is time to apply the Door Puller set. Set includes Nose Puller set NP-4B (above), all in a carrying case.

360-0120	HPC-DP-7B	\$572.50
----------	-----------	----------

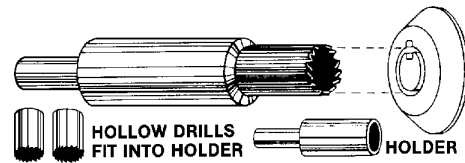
HPC**HPC**

HPC Tubular Lock Drills

These hole saws destroy pins at the shear line. Available for standard & oversize keyways. Fit 1/4" electric drill. Saw life is approximately 3 openings. Not for locks with hardened pins or ball bearings in the keyway.

360-0009	AG-1	Std. Size tool + extra saw	\$72.00
360-0010	AG-2	Oversize tool + extra saw	72.00
360-0155	G-1	Replacement saw for AG-1	23.70

Flat, Round Spring Steel Assortment

HPC-FRS-4. Contains different sizes of most popular flat and round blue steel. Cut into 9" lengths and is packaged in a see-thru round plastic container. 1/2 pound, over 50 pieces.

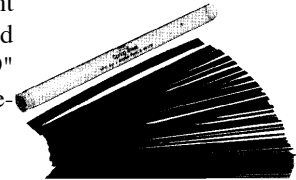

360-1350	HPC FRS-4	\$107.70
----------	-----------	----------

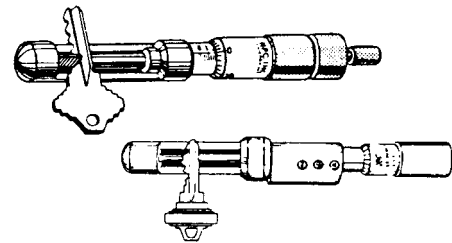

KEY MICROMETERS

SKM-1. Measures Depths of Cuts on Flat Steel & Cylinder Keys. Straight Yoke Type. Supports cut key while checking the depths. Has a hardened anvil, thin enough to check all cylinder keys & flat steel keys with cuts as narrow as .030" in width. Encased in a genuine leather pouch.

360-0346	SKM-1	\$329.00
----------	-------	----------

SKM-2D. "The Ultimate in Key Micrometers". New feature gives instant readings of depths of cuts, without eye strain. Friction thimble keeps user from over-tightening. Satin chrome plated, heavy duty for years of service.

360-0348	SKM-2D	\$686.00
----------	--------	----------

LOCKSMITH TOOLS

HPC Convertible Truarc Ring Pliers

Can quickly & easily convert from ring compressor (external) to ring spreader (internal). Pliers also feature an adjustable stop that limits the jaw opening for both external and internal operation. They can be used on internal rings in sizes of 1/4" to 1" (6.5 to 26mm); and on external rings 1/8" to 1" (3 to 26mm). The TRU-99 comes with 5 pairs of interchangeable tips and a plastic case.

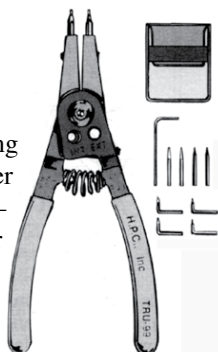

Tips included:

- (2) Silver .047" (1.2 mm)
- (2) Black .036" (0.9mm)
- (2) Copper .023" (0.6mm)
- (2) Silver 90° (2) Black 90°

381-1234	HPC TRU-99	\$55.00
----------	------------	---------

Truarc Ring Pliers

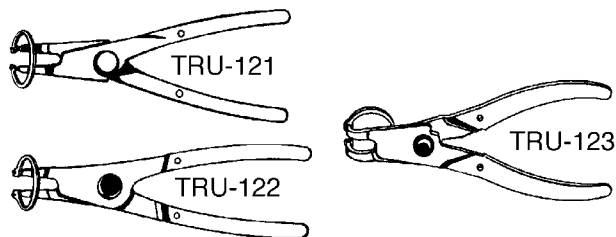

Order #	Item #	Description	Price
360-0497	TRU-121	Ring Compressor	\$39.90
360-0498	TRU-122	Ring Spreader	39.90
360-0499	TRU-123	Ring Compressor	47.00

TRUARC RING PLIERS

HPC-TRU-55.

Two pivot centers - dual operation. No. 1 center is for compressing and No. 2 is for spreading action. Changeovers are made quickly and easily.

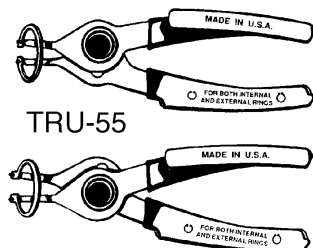

360-0496	(U) TRU-55	\$55.00
----------	------------	---------

Truarc Ring Assortments

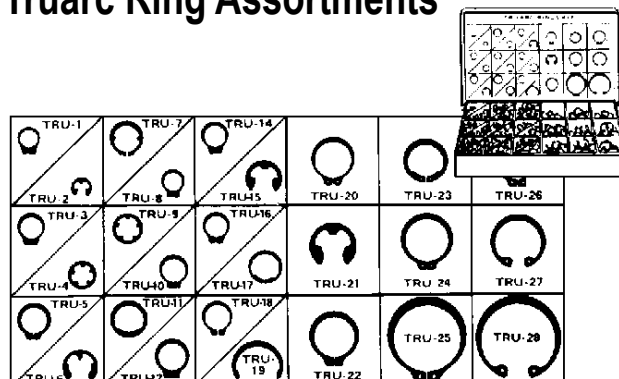

Contains 260 rings in 27 different styles and sizes of Truarc rings and retainers. Made of carbon spring steel for long lasting tension or compression. Helpful for servicing Arrow, Best, Corbin, Dexter, Ilco, Lockwood, National, Schlage and many more.

360-0500	TRU-275	\$195.00
----------	---------	----------

PIN TUMBLER

Tweezers

Groove in tip provides firm, non-twisting grip on cylinder pins for easy loading. Tip is milled back so outside diameter of a standard .115 diameter pin extends past tip. Permits "butting" pin against end of plug follower when loading upper chambers, providing added control when holding tip or master pins of varying lengths. 6" long.

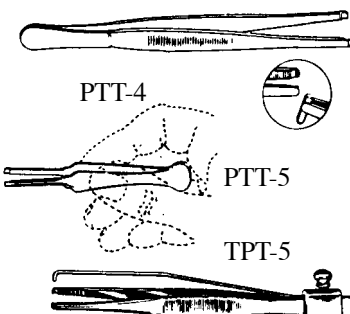

360-0302	PTT-4	\$22.50
----------	-------	---------

PTT-5. Compact Pin Tumbler Tweezer. 4" long . Milled tips firmly grip pins.

360-0303	PTT-5	\$19.00
----------	-------	---------

TPT-5. Improved Pin Tumbler Tweezer has a pin pushing attachment that makes it easier to load top pins into a cylinder.

360-0452	TPT-5	\$41.10
----------	-------	---------

Plug Followers

Adjustable Follower

Spring loaded action bar, fits all standard locks .495" to .600". Handles 90% of all locks.

360-0412 | HPC SUT-22 | \$45.00

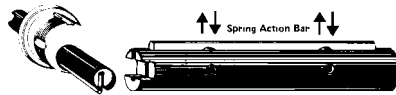

Hollow Brass Follower Set

This set contains three popular sizes of medium-hard, zinc plated, hollow brass followers. Each fits into the other and into their case. Compact.

360-0410 | HPC-SUT-14 | \$39.90

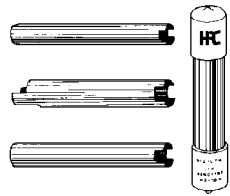

HPC-SUT-0. .395" diameter:

360-0406 | \$15.00



HPC-SUT-1. .495" diameter:

360-0407 | \$19.00

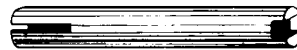

HPC-SUT-3. .500" diameter:

360-0408 | \$19.00



HPC-SUT-10. .550" diameter:

360-0409 | \$17.00



HPC-SUT-47. Set of four:

One each of SUT-0, SUT-1, SUT-3 & SUT-10. 4 followers. Will fit 99% of the rim or mortise cylinders and cylinder units currently in use.

360-0415 | HPC SUT-47 | \$61.00

Plug Follower & Holder Guide Charts

Manufacturer	Follower	Holder
Acrolock	SUT-1	CPH-10
Almont (Peanut cyl)	SUT-0	CPH-15
Arrow	SUT-1	CPH-10
Corbin	SUT-1	CPH-10
Corbin oversize	SUT-10	CPH-20
Corbin (small pins)	SUT-0	CPH-15
Dexter	SUT-1	
Eagle		CPH-10
Eagle (small pins)	SUT-1	CPH-15
Ilco	SUT-1	CPH-10
Ilco (4019 rim cyl)	SUT-3	
Ilco (peanut cyl)	SUT-0	CPH-15
Keil	SUT-1	CPH-10
Keil (#30 rim cyl)	SUT-3	
Kwikset	SUT-1	CPH-10
Lockwood	SUT-1	CPH-10
Lockwood (956 rim cyl)	SUT-3	
National of Rockford (except KNK)	SUT-1	CPH-10
National of Ozone Park	SUT-1	CPH-10
Nesco	SUT-1	CPH-10
Russwin (.5" dia.)	SUT-1	CPH-10
Russwin oversize	SUT-10	CPH-20
Sargent	SUT-1	CPH-10
Schlage	SUT-1	CPH-10
Segal	SUT-1	
Taco	SUT-1	
Taylor	SUT-1	
Weiser (all but Beverly)	SUT-1	CPH-10
Weiser Beverly	SUT-23	CPH-10
Welch	SUT-1	
Weslock (except KNK)	SUT-1	
Yale	SUT-1	CPH-10
Yale (small pins)	SUT-0	CPH-15

Double "D" Metal Punch & Die Sets

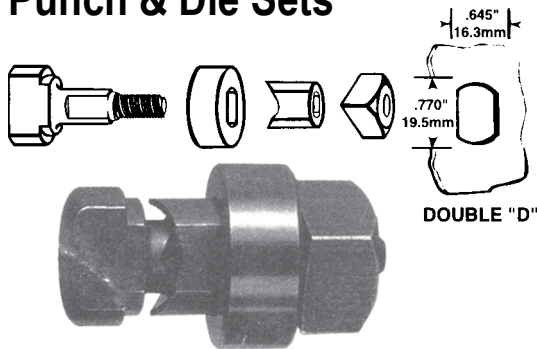

Punches a double "D" hole. A necessary aid to locksmiths installing vending machine and cam locks on metal cabinets, lockers, filing cabinets, and cas boxes made of single wall, sheet metal of 18 gauge or lighter. Punches a .645" x .770" hole in 18 gauge mild steel.

360-0162 | HDPS-4 | \$267.00

Plug Holders

Multiple Cavity Bench Type.

360-0074 | CPH-9 | \$78.20

Multiple Cavity Vise Type

360-0072 | CPH-5 | \$78.20

.510" Hole. Hardened bar stock, black oxide finish.

360-0075 | CPH-10 | \$31.50

Adjustable Plug Holder

The universal adjustable plug vise, adjusts its own hole size from .350" to .600".

360-0417 | \$113.00

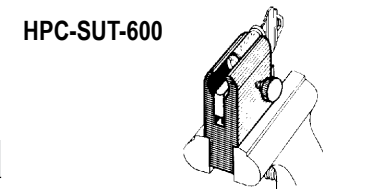
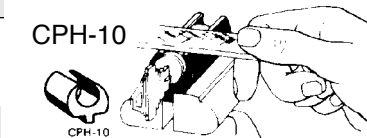
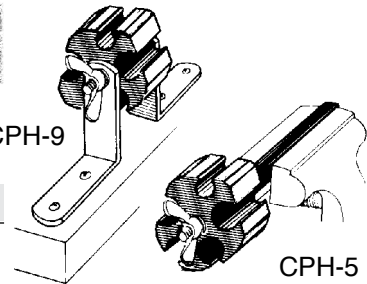

LOCKSMITH TOOLS

HPD-10: Hockey Puck Defeaters

The Hockey Puck Defeater allows you to drill a precise shear line in the cylinder on hockey puck style padlocks without the drill bit walking around the face of the plug. It takes the guesswork out of finding the proper drill point!

Order #	Item #	Catalog Price
360-0630	HPD-10	\$198.00



RPD-10: Round Padlock Defeaters

The Round Padlock Defeater allows you to drill a precise shear line in the cylinder on circular type padlocks. This enables you to bypass the trap door without the drill bit walking around the face of the plug, taking the guesswork out of finding the proper drill point. Another unique feature allows you to effortlessly push the security nut through the trap door for easy removal of the cylinder. The leverage handle allows you to get a good grip on the padlock holder.

Order #	Item #	Catalog Price
360-0635	RPD-10	\$198.00

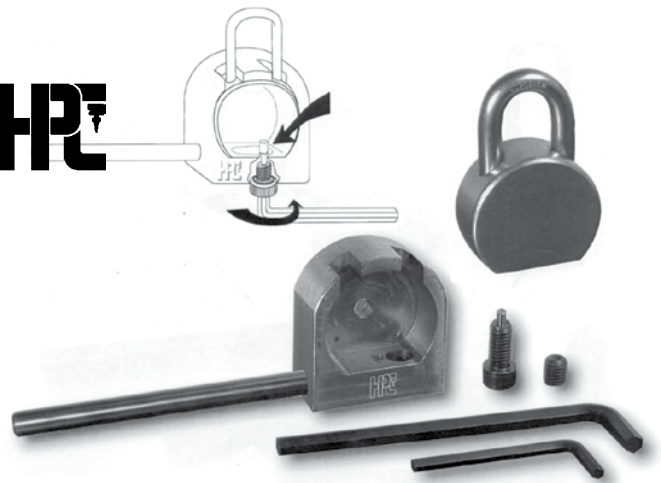

SPD-10: Square Padlock Defeaters

The Square Padlock Defeater takes the guesswork out of finding the proper drill point on square or rectangular hard-body type padlocks. Bypass the trap door and drill the shear line in the cylinder without the drill bit walking around the face of the plug. Alternatively, this tool enables you to effortlessly push the security nut through the trap door to easily remove the cylinder. The leverage handle allows you to get a good grip on the padlock holder. The Square Padlock Defeater comes with a set of removable shims to fit the most popular size padlocks.

Order #	Item #	Catalog Price
360-0640	SPD-10	\$198.00

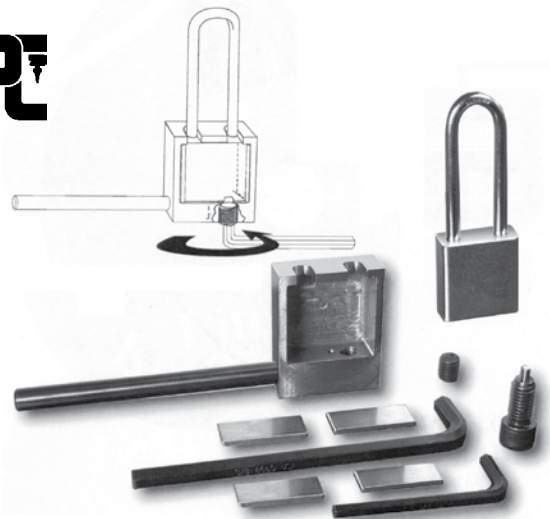



SSM-36: Sturdy Strike Markers

The Sturdy Strike Marker easily marks strike location on wood and steel jambs. It features durable solid steel construction with replaceable hardened steel tips.

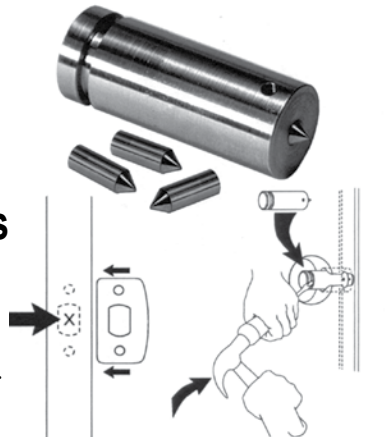

Order #	Item #	Catalog Price
360-0625	SSM-36	\$119.98

EBM-234: Easy Backset Marker

The Easy Backset Marker marks backset location for 2 3/4" and 2 3/8" backset. It includes edge boremarks and is quick and easy to use! Installing locksets and deadbolts is an everyday occurrence. This new tool makes it easy to accurately mark the backset on the door when a jig is not available.

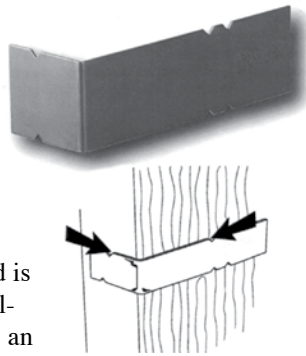

Order #	Item #	Catalog Price
360-0620	EBM-234	\$12.20

FSR-T100: F Series Remover

The design of the F series cylinder can make it difficult to pick. The F Series Manipulation Tool allows you to defeat these locksets with ease. Manipulate F Series leversets through the existing opening in the back of the handle. Open F Series knoblocks the same way after making a small hole in the lock neck. The HPC F Series Manipulation Tool is designed so that You Only Need This One Tool to open either levers or knobs regardless of the handing of the door. It even works great around tight jambs where other tools don't fit.

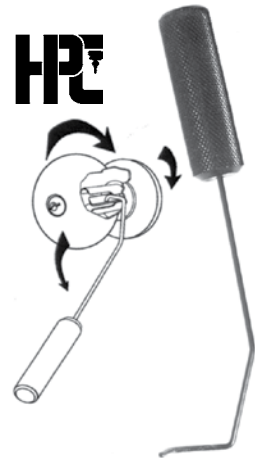

Order #	Item #	Catalog Price
360-0610	FSR-T100	\$45.98

FSR-100: P Series Remover

The F Series Pliers are designed to punch a small hole in the neck of F Series knobs so that the manipulation tool can be used to open the lock. These pliers are specifically designed to work around tight jambs like no other tool. This specially designed tool cuts a small crescent hole and pushes the metal away. After opening the lock the metal can be bent back to cover the opening with a flat blade screwdriver.



Order #	Item #	Catalog Price
360-0615	FSR-P100	\$159.98

The F Series Pliers are not needed for opening F-Series Leversets.



Cylinder Eater™ No. CE-6000

This drill attachment will chew up every cylinder you put in front of it! The replaceable tips allows you to instantly devour mailbox locks, knoblocks, deadbolts, IC and more, gnawing through shear lines with fool-proof accuracy.

The optional carbide bit gobbles up high-security cylinders as well. Throw away all of your cylinder jigs and open everything with just one tool! The HPC Cylinder Eater™ is a must-have for every security specialist who must bypass locked cylinders! Comes with drill attachment and 3 tips (.395, .500 and .550). Additional tips and bits coming soon for Medeco®, Kaba, Primus®, GM and more!



Order #	Item #	Catalog Price
360-0300	CE-6000	\$499.98

LOCKSMITH TOOLS



Illuminated Pin Stations



This station secures to your table top and comes with a multi-size plug holder and illuminated followers that brighten up the inside of cylinder housings with natural light. Illuminated followers are also available separately.

Order #	Item #	Catalog Price
360-0174	IPIN-99	\$279.90

Illuminated Followers

Order #	Item #	Size	Catalog Price
360-0170	IF-395	.395	\$49.00
360-0172	IF-495	.495	49.00
360-0173	IF-550	.550	49.00

Top Pin Loader

This tool makes loading top pins and springs easier than ever. One side is .495, and the other is .550. Perfect for your most popular rekeying jobs.



Order #	Item #	Catalog Price
360-0440	TPIN2	\$151.90



Clean Grip Impressioning Tools

Holds onto the center of the key blank, not the face. This eliminates the possibility of scratching the key blank, while providing a firm hold. It has a unique locking mechanism with a retaining pin that ensures a tight grip on the key blank. The cushioned handle is comfortable and easy to hold. This tool will hold a variety of key blanks and has been designed to be simple, quick, and dependable - with a professional end result. With the key blank locked in place, you are ready to impression securely.

Order #	Item #	Price
360-0110	CGIT-10	\$147.00



Key Decoders

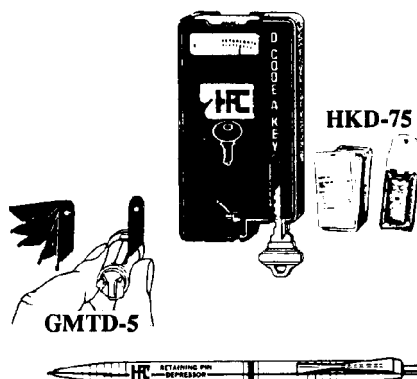

Pocket sized decoder kit determines original factory depths of most popular domestic pin & disc tumbler cylinder & automotive keys. Insert correct information card into top slot of decoder. Lowering depth pin into each cut, from bow to tip, will indicate correct depths, in window at top.

360-0164	HKD-75	\$399.90
----------	--------	----------

GM Tumbler Decoder Gauges

GMTD-5. Eliminates guess work reading GM tumblers. Press inward on side bar & rake tumblers until side bar moves in to unlocked position. Place gauge pin over each wafer until shoulder stop butts against top of plug.

360-0161	GMTD-5	\$23.30
----------	--------	---------

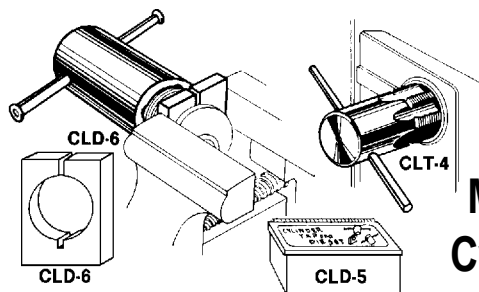

Mortise Cylinder Lock

Tap and Die Sets

CLD-6. Cylinder re-threading die holding fixture.

360-0049	CLD-6	\$157.00
----------	-------	----------

CLT-4. Lock Case Re-tapping Tap.

360-0050	CLT-4	\$157.00
----------	-------	----------

CLT-5. Complete Tap & Die Kit with Cylinder Holding Fixture & metal box. Re-Thread Cylinders and Cases.

360-0051	CLT-5	\$339.90
----------	-------	----------

Safe Change Keys

Diebold

SLC-19. Double end key series 180
177 & 900 (2 keys in one)

Order #	HPC #	Price
360-0371	SLC-19	\$62.00

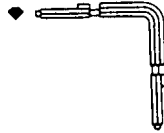

Mosler

360-0361	SLC-9	\$62.00
----------	-------	---------

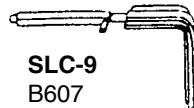

HPC/ La Gard

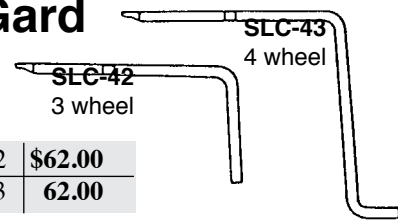

360-0391	SLC-42	\$62.00
360-0392	SLC-43	62.00

Sargent & Greenleaf

SLC-4 (Same as SLC-31) 6720, 6721, 6722, 6723,
6725, 6726, 6730, 6732, 6735, T8410MP, T8415MP,
ET8410MP, ET8415MP

360-0356	SLC-4	\$62.00
----------	-------	---------

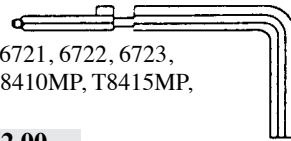

Lighting Tools

Flex-A-Light™

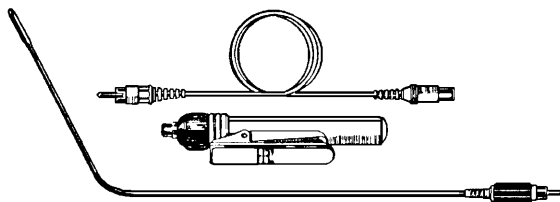

Stop Working in the Dark!

Speed up your opening jobs, Reduce hassle & frustration:
FAL-10. 10" Flex-A-Light and Power Handle

360-3010	HPC-FAL-15X	\$123.00
----------	-------------	----------

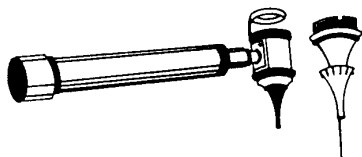

Magna Scope

MGS-1. An economically priced Oscope ideal for magnifying and illuminating hard to see areas. Packed with three speculas, pin depressor assembly and soft plastic carrying pouch. Uses "C" batteries (not included).

360-0244	HPC MGS-1	\$284.00
----------	-----------	----------



Multi-Purpose Spotlight No. MPS-300

The Multi-Purpose Spotlight is a heavy-duty super bright gooseneck light that is ideal for all types of vehicle work and can be used in a van as a portable shop light. Equipped with long lasting LEDs, you can count on both of these to lighten your load!



Order #	Item #	Catalog Price
360-0360	MPS-300	\$139.98

Dual-Mode Illuminator No. DMI-300

Stop working in the shadows!
This light will illuminate the dark interiors that haunt your late-night openings!

The Dual-Mode Illuminator, with twist-on suction cup can be bent and turned in any direction, shining three times brighter than others do. Plus, the strobe-mode can be used to alert oncoming traffic when you have to work on the street side of a locked car.



Order #	Item #	Catalog Price
360-0370	DMI-300	\$75.98

LOCKSMITH TOOLS

Ace Tools

Tubular Lock Picks

TLP-GUARD. Stationary Guarded Locks



Designed to defeat those tubular locks equipped with dome-shaped shroud or "guard" that require a special, long shank key. It operates like the TLP-CMOD-B and is also effective on standard 7 pin locks. Aluminum handle with feeler reset lever, stainless steel barrel and spring steel feelers. With leather case and TKPD-1 decoder.

360-1417	HPC-TLP-GUARD	\$399.90
----------	---------------	----------

TLP-CMOD-B. Standard 7 Pin Tubular Locks



Aluminum handle, stainless steel body and spring steel feelers. Opens most locks in seconds. Employs a collet and O-ring. This design permits infinitely variable tension against the feelers. Most widely used tubular lock pick in the industry. In a genuine leather case with the TKPD-1 decoder.

360-0436	HPC-TLP-CMOD-B	\$173.70
----------	----------------	----------

TLP-PEANUT. Standard 7-pin Tubular Locks

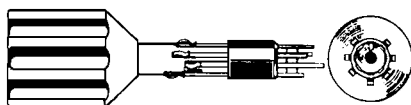

HPC's most economical tubular lock pick, yet it offers numerous features, making it a highly effective tool. The barrel is composed of Delrin which enables the wall thickness to be minimal without the brittle tendency of most metals. Also, a silicon O-ring is utilized to maintain steady feeler tension. A spring loaded center pin enables locks to virtually pick themselves. The TKPD-1 decoder included.

360-1400	HPC-TLP-PEANUT	\$98.70
----------	----------------	---------

HPC Pick Sets

Double Sided Disc Tumbler Lock Picks

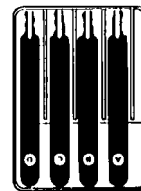

DSP-1. Set of 4 picks used on the most popular dbl. sided, disc tumbler, showcase, cam and padlocks.

360-0126	HPC-DSP-1	\$34.70
----------	-----------	---------

Pocket Killer Kit. AKK-P17.

16-piece assortment (10 picks, 4 tension tools, and 2 extractors). Pocket size kit includes CO-58 collapsible car opener. Leather Case.

\$154.00

360-1450	HPC-AKK-P17
----------	-------------

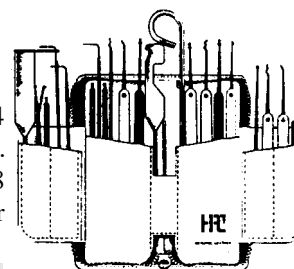

Computer Generated Picks

Contains Nine (9) Computer designed picks and 2 tension tools, made of hardened stainless and spring steel components.

Designed for more picking possibilities.

360-0070	HPC-COMP-1	\$139.50
----------	------------	----------

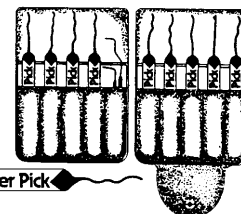

HPC Computer Pick

Padlock Shim Picks

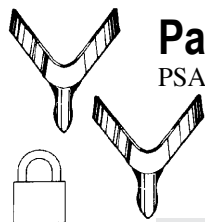

PSA-20, 20 piece padlock shim assortment.

Alternative to picking and in many situations, the only way to open a laminated padlock in seconds.

\$58.50 SET

360-1004	HPC-PSA-20
----------	------------

Warded Padlock Pick Set

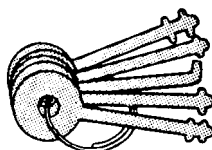

Compact set efficiently opens warded padlocks. 5-picks on a key ring

\$19.90

360-0295	HPC-PKS
----------	---------

HPC Pick Sets Extractors Tool Set

The ultimate in broken key and pick removal. Tools are designed to slide next to broken keys along the side mill and ride along the bottom pins to hook into a cut in the key. Tools can be bent to side angles to reach around many obstacles. High grade stainless steel body.



Key Pullers

ES-2000. 4 piece set in a leather case.

360-0995 | HPC-ES2000 | **\$51.50**

Extractors sold individually **\$9.30 each:**

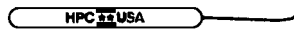
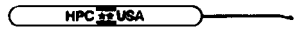
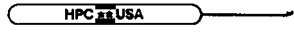
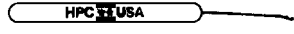
	360-1000	SSX-10
	360-1001	SSX-11
	360-1002	SSX-20
	360-1003	SSX-21

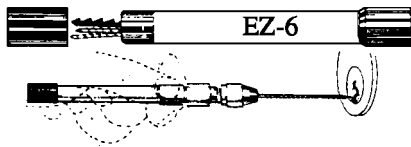

Changeable Vise Head Key Extractor Set

Four changeable blades stored inside hollow handle.

360-0142 | EZ-6 | **\$37.00**

Extractor replacement blades (10 /pack)

360-0143	EZ-7A	Saw type	\$22.00 pk
360-0144	EZ-7B	Round, .040"/1mm. dia.	28.80 pk
360-0145	EZ-7C	Round, .050"/1.27mm. dia.	28.80 pk
360-0146	EZ-7D	Assortment: 4 of 7A, 4 of 7B, 2 of 7C	22.60 pk

PIP-2000 Pick Sets

Consists of 9 picks & 4 extractors, which have been engineered to outperform any other tool on the market.

Design permits easier access into even the most restrictive keyways. Leather case.

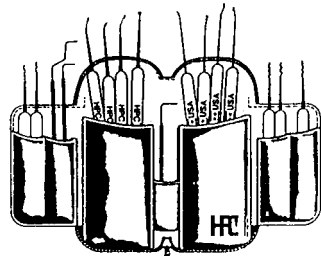

360-2000 | HPC-PIP-2000 | **\$159.90**

On-Call Belt Pick Sets

Comes complete with 16 picks, 2 tension tools, and 2 extractors.

The case is made of genuine leather with an official Locksmith I.D. badge on the front.

The case is secured on your belt by an adjustable leather strap

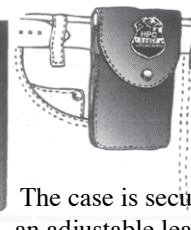
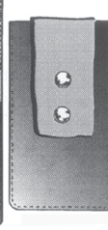
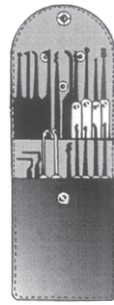

360-1204 | HPC OC-16 | **\$122.00**

On-Hand Belt Pick Set

Complete with 8 picks, 2 tension tools, and HPC's EX-6 Changeable Vise Head Key Extractor Set. The case is made of genuine leather and is secured on your belt by two adjustable leather straps.

360-1205 | HKPC OH-8 | **\$122.00**

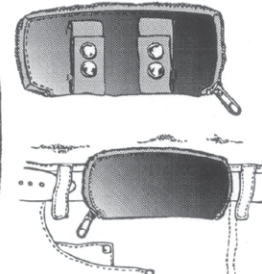
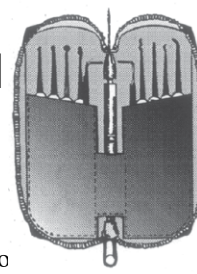

Jackknife Pick Sets HPC JKP-5

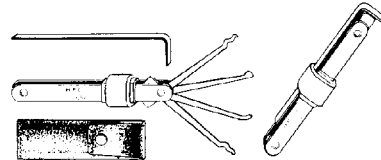

Pocket Knife shaped Compact pick set has 2 rakes, 1 diamond, 1 hook, & 1 tension wrench. Folds into a compact case (sold below).

360-0185 | HPC-JKP-5 | **\$31.90**

CASE for Jackknife Pick Set.

360-0186 | HPC-JPO-1 | **\$14.00**

Belt Pick Sets

Fits directly onto belt, can be worn anywhere. Comes equipped with six new tools (3 picks, 1 extractor, and 2 tension tools). Overall length of each tool is three inches. Tools lie flat in leather crafted case. Case is only 3.5" long by 2.25" wide, can be worn discreetly.

360-1460 | HPC-KGB-1 | **\$62.00**



LOCKSMITH TOOLS



Pick Sets

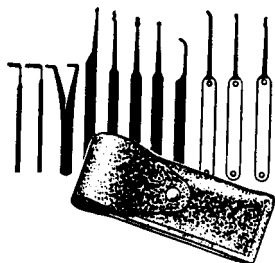

Novice Pick Set. PIP-13

Contains 11 picks, tension wrenches, and a broken key extractor in a cowhide leather case.

360-0293	HPC-PIP-13	\$37.90
----------	------------	---------

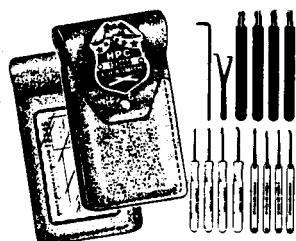

I.D. Badge Pick Set. PIP-23

14 picking tools, badge inscribed with personal I.D. number.

360-0294	HPC-PIP-23	\$106.20
----------	------------	----------

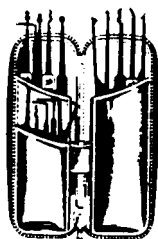

Deluxe Pick Sets NDPK

Shirt pocket size (2-5/8" x 6-3/8" closed). Top grain leather case. Spring steel tools. 16 picks, tension tools, & extractor.

360-0254	HPC-NDPK	\$73.50
----------	----------	---------

Pro-Mixer Pick Sets NDPK-24

24 picks & tension tools in a black leather zipper case. Mixes HPC regular tools & "2000" Series. Shirt pocket size (2-5/8" x 6-3/8" closed).

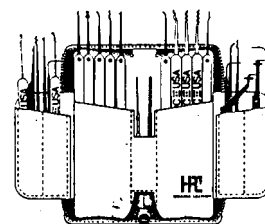

360-1445	HPC-NDPK-24	\$119.98
----------	-------------	----------

Superior Pick Set. NDPK-32

Hip pocket size, grain leather case. Spring steel tools. Hand finished components. 32 picks, tension tools & extractors. Closed case measures 2-5/8" x 6-3/8". Leather case with full zipper.

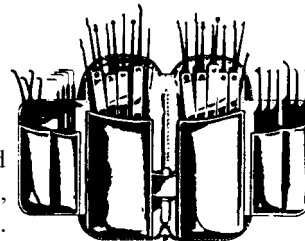

360-0255	HPC-NDPK-32	\$109.50
----------	-------------	----------

Professional Pick Sets NDPK-60

60 picks, tension wrenches & extractor. A general assortment of the most popular. Closed case measures 4" x 6-1/2". Leather case with full zipper.

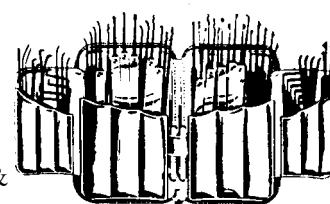

360-0256	HPC-NDPK-60	\$206.00
----------	-------------	----------

Paramount Pick Set NDPK-100

Contains 100 picking tools. This set is for the discriminating locksmith who desires an extensive assortment of lock picking tools, so that replacement will be unnecessary for some time. Contains a wide choice of full, half and 3/4 rakes and diamond tips; half, single and double ball picks; light, medium, and heavy weight tension wrenches; hook and saw type key extractors and a set of warded padlock pick keys. Tool kit size is 6" x 9" closed. Genuine leather case with full zipper.

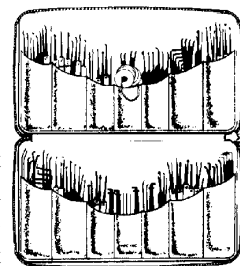

360-0257	NDPK-100	\$338.00
----------	----------	----------



HPC Color Coded Picks

Make Your Job a Little Easier

The series includes a different color for each type of pick: red for rakes, blue for hooks, green for balls, and gold for diamonds.

Make Your Own Pick Sets: (Cases not included)

15 Piece Color Coded Pick Pack

Contains: 2 Tension Tools

- 4 Rakes . . Red Handle
- 2 Diamonds . . Gold Handle
- 2 Extractors . . Silver Handle
- 3 Hooks . . Blue Handle
- 2 Balls . . Green Handle

Order #	Item #	Price
360-1500	CCPK-15	\$45.90

25 Piece Color Coded Pick Pack

Contains: 4 Tension Tools

- 4 Hooks . . Blue Handle
- 3 Balls . . Green Handle
- 3 Extractors . . Silver Handle
- 8 Rakes . . Red Handle
- 3 Diamonds . . Gold Handle
- 3 Extractors . . Silver Handle

360-1501	CCPK-25	\$73.90
----------	---------	----------------

35 Piece Color Coded Pick Pack

Contains: 5 Tension Tools

- 5 Hooks . . Blue Handle
- 5 Balls . . Green Handle
- 5 Extractors . . Silver Handle
- 10 Rakes . . Red Handle
- 5 Diamonds . . Gold Handle
- 5 Extractors . . Silver Handle

360-1502	CCPK-35	\$95.90
----------	---------	----------------

Individual Color Coded Picks

\$3.70 Each (Pictured top to bottom)

Order #	Item #	Pick Type
360-1510	CLPX-11R	Red Rake
360-1511	CHLPX-11R	Red Rake
360-1512	CLPX-16R	Red rake
360-1513	CLPX-15R	Red Rake
360-1514	CPX-31H	Blue Hook
360-1515	CLPX-12H	Blue Hook
360-1516	CHLPX-12H	Blue Hook
360-1517	CBPX-41B	Green Ball
360-1518	CBPX-5B	Green Ball
360-1519	CLPX-10D	Gold Diamond
360-1520	CHLPX-10D	Gold Diamond

HPC's Color Coded Pick Sets

Makes finding the pick you need quicker than ever. No need to fumble through all of your picks to find the rake you're looking for, the red rakes in your set are so vibrant that you won't miss them.



HPC's Color Coded Pick Set includes a different color for each type of pick:

- 10 Rakes . . Red Handle
- 5 Hooks . . Blue Handle
- 5 Diamonds . . Gold Handle
- 5 Balls . . Green Handle
- 5 Extractors . . Silver Handle
- 5 Tension Tools
- 1 Case

COLOR-35 includes HPC's soft leather NKPK case and 35 Piece Color Coded Pick Pack.

Order #	Item #	Price
360-0035	COLOR-35	\$129.00

LOCKSMITH TOOLS



Hands-Free Tension Tool Kit

Refines the Art of Lock picking

HPC's Hands-Free Tension Tool Kit takes the difficulty out of picking. No need to fumble with the tension. Simply slip the tool into your cylinder keyway (vertical or horizontal), slide and set the weight to adjust the amount of tension, and then let go! All that's left is raking the pins. Kit is complete with a Hands-Free Tension Tool and a matching 2-sided rake/diamond. The Tension and Picking tools clip together with a specially designed holder.

Order #	Item #	Price
360-0003	HFTT-KIT	\$98.00

Hands-Free Tension Tool Kit

Picking is no longer a two handed job!

Tension Tools

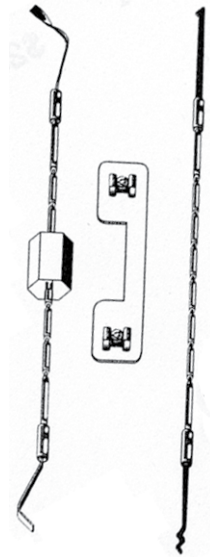

Glow Picks

Lighten up your work with this changeable pick with built in flashlight. Comes with 14 different stainless steel pick ends.

Order #	Item #	Catalog Price
360-0158	(U) GLOW-14	\$171.00



(U) Available while supplies last

Tension Wrenches

Light Tension: \$3.98 each

360-0460	TR-9	5-1/4"
360-0458	TR-7	3-1/4"

Medium Tension: \$3.98 ea

360-0466	TR-23	3-1/4"
360-0468	TR-25	5-1/4"

RIGID TENSION

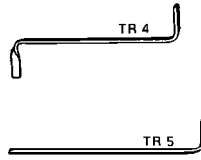

Rigid Tension: \$3.98 ea

360-0455	TR-4	2-1/4"
360-0456	TR-5	3-3/4"

Tension Tools

LIGHT TENSION

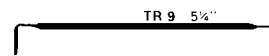

MEDIUM TENSION

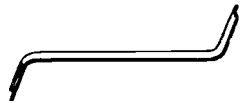
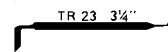

RIGID. Double Sided Grooved. 2"
360-0510 | VV-6 | \$6.30 ea

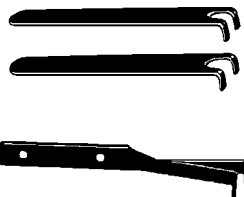

Double-Sided Tension Wrench
Medium Tension

360-0425	TEN-7	3.80
----------	-------	------

Variable Tension

360-0405	STW-3	4.30
----------	-------	------

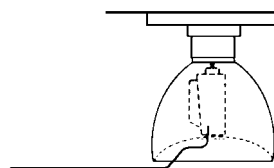

Tension Tools for Tulip Knobs
Rigid Tension

360-0453	TR-2	\$3.98
----------	------	--------

Medium Tension

360-0465	TR-22	3.98
----------	-------	------

Letter Box Type:

\$3.50 each

360-0424	TEN-5	1-1/2"
----------	-------	--------

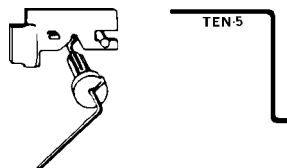

RAKES:

Stainless Handle:

360-0232	LPX-11 (.022)	3.10
360-0166	HLPX-11 (.025)	3.20

360-0234	LPX-15 (.022)	3.20
360-0235	LPX-16 (.022)	3.20

Vinyl Handle:

360-0080	CPX-11	3.60
----------	--------	------

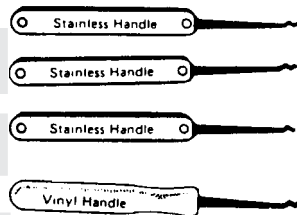

EXTRACTORS:

360-0138	EZ-1	\$4.80
360-0141	EZ-5	6.70
360-0139	EZ-2	2.10
360-0140	EZ3	4.90

DIAMONDS:

360-0231	LPX-10 (.022)	3.10
360-0165	HLPX-10 (.025)	3.20
360-0079	CPX-10	3.60

HOOKS:

360-0233	LPX-12 (.022)	3.10
360-0167	HLPX-12 (.025)	3.20
360-0081	CPX-12	3.60

Replacement Pick Needles

360-0269	P-3 Curved (.022)	\$2.80
360-0268	P-2 Straight (.022)	2.80

LOCKSMITH TOOLS

HPC Pistol Pick

Pick Guns

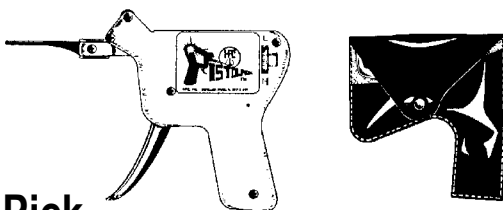

Replacement Pick Needles:		
360-0269	P-3 Curved	2.80
360-0268	P-2 Straight	\$2.80

Designed with the locksmith in mind Picks pin & disc tumbler with ease. All parts, including the main housing are nickel plated cold rolled steel for protection against rust, and provide an attractive high quality true pistol finish. Moving parts can easily be replaced- Pistolpick can be opened with a screwdriver. (ordered thru HPC Service Center). Comes with picks & tension tool.

360-1440	HPC HPG-10	\$69.90
----------	------------	---------

Optional Case: HPG-CASE (Black Holster)

360-1441	HPG-CASE	\$30.68
----------	----------	---------

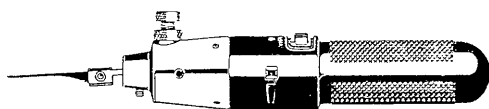

HPC Electric Pick Guns

Cordless rechargeable Electric Pick Gun, EPG-1. Duplicate exact raking motions many times per second. Rakes open pin & disc tumbler cylinders using rapid up & down striking movement, causing tip & bottom pins to separate, meeting shear-line. Adjustable thumb-screw controls up & down motion. With charger (for bench/wall mount), 3 raking & 2 tension tools.

360-1439	HPC-EPG-1	\$282.00
----------	-----------	----------

12-Volt Charger

This 12 volt DC charger enables the HPC Electropick to be recharged in your mobile lock shop. (Note: Electropick is sold separately.)

360-1438	HPC-EPCG-12	\$95.90
----------	-------------	---------



Plug Spinners

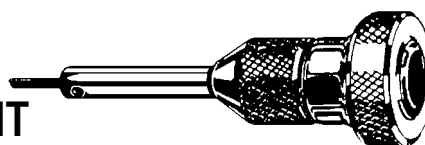

HPC FLIP-IT

FIT-2. When picking a lock in the wrong direction (intentionally or by error) Flip-It will flip cylinder plug past upper pins and save you the job of re-picking. Two pin Quick Lock/Release feature allows for easy release of rotating action. Sure stop feature prevents over winding in either direction. Carries HPC's new HQ (High Quality) 5 year warranty.

360-1465	HPC-FIT-2	\$99.90
----------	-----------	---------

Pick Grip Handle



This soft foam pick grip is for picks with or without metal handles. Its unique design grips tools without any adhesive. 3/16" round, the inside diameter expands to also hold: files, wire cutters, tweezers, car openers, etc. Provides maximum pulling strength for key extractors.

360-2447	Pick Grip	\$13.30	pack of 10
----------	-----------	---------	------------

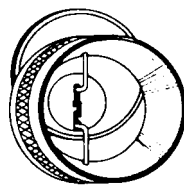

Front View



TNT-15

TNT-20

Tension Tools

Tension wrench is improved version of TNT-15. TNT-20 incorporates spring activated tension that is utilized in the TNT-1 thru 4. Also has spring-loaded adjustable tension prongs, which can be adjusted to the size of the keyway. Works well on small keyways that are flush with the shell (such as those

found on padlocks & file cabinet locks), as well as standard rim & mortise cylinders. Also works with some foreign and domestic cylinders.

360-2445	HPC-TNT-20	\$93.00
----------	------------	---------

Order #	HPC-#	Description	Price
360-0451	TNT-15	Regular house cylinder	\$37.50

Door Jak, a door installation cart that allows one worker to transport and install a heavy and/or over-size door easily, safely, and quickly.

Hardnox
Door Jak

The Door Jak has been tested and improved on commercial construction sites for years. Used properly, one worker can install fire-rated, lead-lined, solid-core and commercial-grade doors* in less time, more safely and easily than two workers using conventional methods. Adjustments perfectly align the door to fit the door jamb. Using the Door Jak as instructed can save time and reduce the risk of worker injury, while increasing productivity. Collapsible for convenient storage, the Door Jak is heavy duty and powder coated.

* Up to 4'x7' x 1-3/4", 250 lbs. Additional worker should accompany larger, heavier door.

Order #	Item #	Price
367-0001	Door Jak	\$5990.00



Who Needs a Door Jak?

- Health Care facilities
- Commercial General Contractors
- Tool Rental Companies
- Government Facilities
- Building Maintenance Crews
- Commercial Finish Carpenters
- University Maintenance Crews
- Flooring Installation Crews.

Weight: Approx. 125 lbs.
Limited one year warranty



Transport it . . .



to the jamb . . .



hang it . . .



on to the next one!

Hardnox Door Jak 50

The sturdy, portable door installation cart.

The Door jak is the only professional door installation cart that allows one worker to safely transport and install heavy commercial and residential doors.

- Folds to 26" x 45" x 7" for storage and transport.
- Wide Wheel Base insures safe and stable use.
- Heavy Gauge Door Support Pad, with slip proof surface.
- Powder Coated. • Safety Wheel Locks.
- Door Height Adjuster, fine tunes door position within 1/64" and has a 2" overall lift.
- Attachment Strap, will not scratch pre-finished doors.
- Release Pin, moves door from a 75° transport angle to an upright 90° installation position easily.

Order #	Item #	Catalog Price
367-0002	Door Jak 50	\$1370.00



More info at www.doorjak.com
(Assembly required)

LOCKSMITH TOOLS

THE DOOR DOLLY™

Door Installation Made Easy!

Hang one door or 100 doors in half the time, and move granite or 4x8 plywood by yourself. No need for an extra pair of hands.

Finally a low cost device which makes transporting and installing doors easier. The Door Dolly will hold a door securely in a horizontal position while hinges are mortised and installed. Then, it allows you to swing the door up to a vertical position while hinge pins are installed on the door jamb. Afterwards, simply roll the door into place for final installation and adjustment. Heavy gauge aluminum construction and easy clamping devices protect the door from damage while holding it securely in place. Easy, quick release feature when done.

Door installation made easy.

Protective rubberized padding on clamping devices protect even the most expensive solid wood doors from damage.

The Door Dolly handle telescopes and collapses for installation support and easy storage.

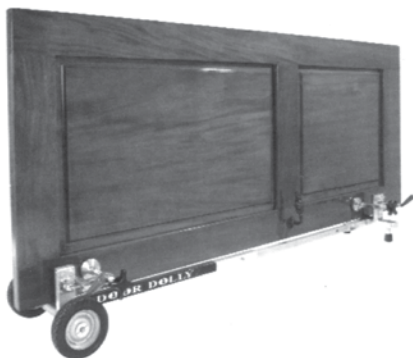
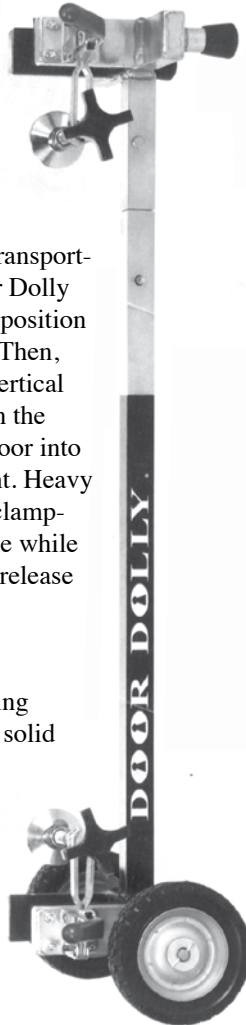

Protective paddings

Order #	Item #	Catalog Price
966-0005	WDG	\$698.00

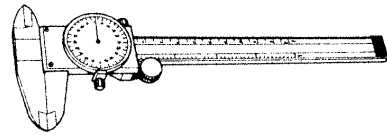

Micro-Dial Calipers

Gives instant foot depth measurements, reading from back of key blank to depth of cut. Checks center of cut from bow key stop and distance from center to center of cuts on the key blank with the cut key in the plug. Checks length of the pin required.

400-2180	884-00-21	\$259.20
----------	-----------	----------

ILCO Replacement Pick Blades:

for Electric Lockpick (# 817-00-8X)

400-7002	817-01	\$5.26 each
----------	--------	-------------

Ilco



Rekeying Tool For Titan Locks

In order to re-key the Titan lock, you must cut one of these re-keying tools to the proper change key in order to remove the cylinder.

\$.64 Each

Order #	Item #	Catalog Price
400-2181	1176RK	\$1.16 each

KEEDEX

Installation Tools

Installation Template

for Adams Rite

Tool allows you to make precise installation of Adams Rite 1850, 4530, 4710 & 4711 series locks.

It also works with the International DH1822 & DL4511.

For 7/8", 31/32" and 1-1/8" backsets.

Includes guide for Adams Rite exit indicator 4089 Has cutout for BBW #5024 & International HB4085 flush bolts. Designed to be used with a 1/2" router guide with a 1/4" bit.

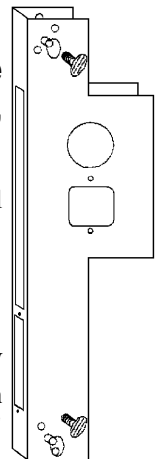

435-0080	KEE K-TMPA/R	\$118.16
----------	--------------	----------



Tamper Resistant Screwdrivers

Invaluable for

- Automotive Work
- Access Control
- Commercial & Institutional Locksmithing

Keedex has a new Tamper Resistant Screwdriver. This screwdriver comes with eleven interchangeable tips. Includes the following:

- **Six torx tips** (T10, T15, T20, T25, T27, & T30)
- **Three hex tips** (5/32", 3/16", & 7/32")
- **Two Spanner Tips** (#6, & #8)

All tips fit into the screwdriver's storage handle.

Order #	Item	Catalog Price
435-0115	TRS	\$80.08

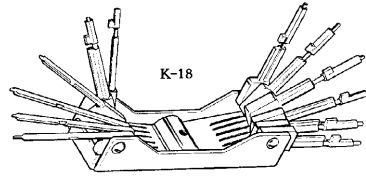
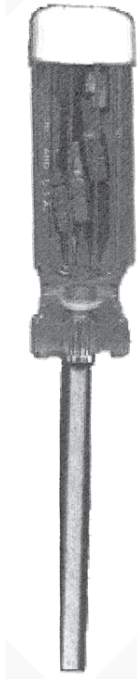

K-18. Set of 12 most common change keys in handy case. Keys fold out "knife style". Case engraved with description of uses. Keys made of stainless steel.

Safe Change Keys Change Key Sets

- Diebold 177-4 Wheel
- S&G Padlock-3 Wheel
- LaGard-3 Wheel
- LaGard-4 Wheel
- LaGard AMSEC-3 Wheel
- Mosler 35-4 Wheel
- Mosler 302-3 Wheel
- S&G AMSEC 3 Wheel
- S&G 6720-3 Wheel
- Diebold 180-3 Wheel

435-0018	K-18	\$196.00
----------	------	-----------------

GSA Type Change Ket Set:

Designed for those working in the GSA environment. Contains the keys needed for servicing GSA rated containers. Keys are made of cast stainless steel. Case is engraved with description of uses.

Contains the following Keys:

- | | |
|-----------------------------------|-------------------------|
| #1 Phillips head | #2 Mosler 302 |
| #3 LaGard-Metal Wheel | #4 LaGard-Plastic Wheel |
| #5 S & G 4 Wheel (8400) | #6 S & G 3 Wheel (Std) |
| #7 8077 Reset | #8 8077 Reset |
| #9 8077 Change Key | #10 Flat Screwdriver |
| #11 Centi Spline Allen Wrench | |
| #12 Mosler Attaching Allen Wrench | |

435-0020	KEE GSA	\$200.12
----------	----------------	-----------------



K-22. Lever Opening Tools

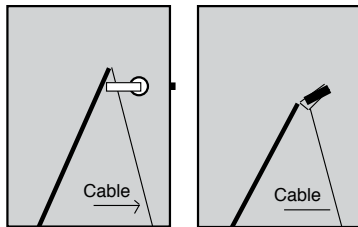

Opens lever style door knobs. If you can slide this tool under the door, you will open it.

Order #	Item #	Catalog Price
435-0022	K-22	\$58.10

Replacement Cable for K-22 Lever Opening Tool



Order #	Item #	Catalog Price
435-0023	K-22CABLE	\$16.14



GM Decoders

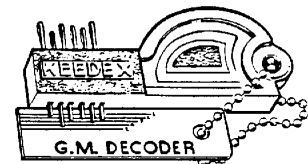

K-4. Decodes all tumblers in one step without disassembly of the lock. Pick sidebar down. Press the K-4 firmly into the 6 chambers of the lock. Read cuts with gauge provided. * Instructions & case included.

- * Guaranteed for life
- * Stainless steel fingers
- * Aluminum card

435-0004	K-4	\$35.08
----------	-----	----------------

KEEDEX "SPIN OUT" Screwdrivers for Mortise Cylinders

Designed to remove the most stubborn screws on mortise cylinders. Features a screwdriver with an oversized handle for extra torque. Four sizes of interchangeable screwdriver bits - two slotted and two Phillips. Includes stand with bronze bearing, to prevent screwdriver from slipping and causing injury. Allows constant, even pressure to screws. Prevents stripped out screw heads.

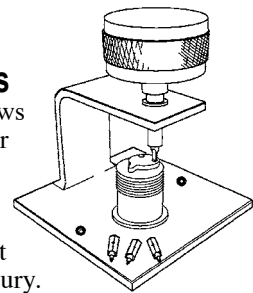

Order #	Item	Price
435-0010	SPIN OUT	\$159.62

LOCKSMITH TOOLS



Safe Tools

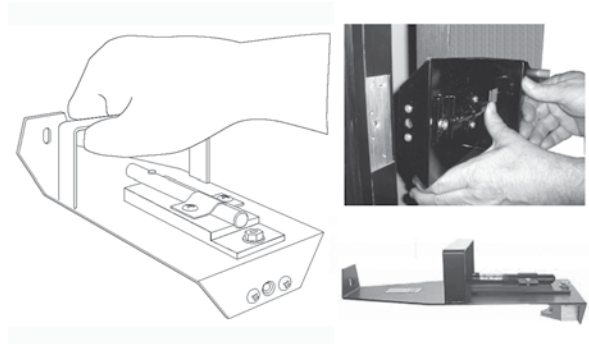
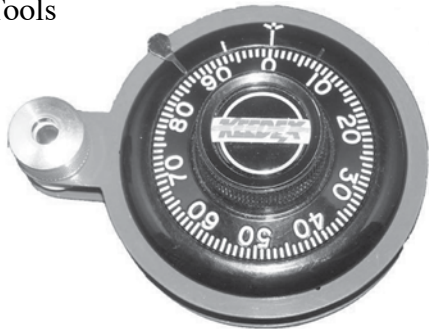

Installation Tools

Emergency Transfer Dial

Allows dialing of a safe away from the drill point.
 Easy transfer of gate to any position fast and accurately.
 Precise one-to-one ratio between dial and spindle.
 Easy to read large format dial.
 Attaches strongly with the use of rare earth magnets.

Order #	Item #	Catalog Price
435-0120	K-ETD	\$290.90

DoorLaser

The Affordable and Effective Tool for Core Drilling Doors

Use of Laser Sight assures accurate drilling.
 Includes 1/4" bit for drilling pilot hole

Order #	Item #	Catalog Price
435-0125	DRLSR	\$400.84

kwikset



**SMART KEY
SmartKey Reset Cradle
and Smart Key Tool**

- 1A. Before you begin, rotate lower dial to the right until it stops to align arrow on upper grip with start point on inner dial.
- 2B. Insert cylinder all the way into the inner dial
- 3C. Rotate lower dial half turn to the left until it stops, where the two arrows meet.
- 2A. Insert the SmartKey tool into the small hole on the cylinder face, and push with force until it goes all the way in, then remove the SmartKey tool
- 2B. Insert the key you want to learn in the plug, while being sure not to rotate the plug.
- 2C. Remove the plug from the reset cradle by gently pulling on the key.
- 3A While holding the cylinder body stationary, rotate the key back to the home position.
- 3B. Remove the key
- 3C. Reinstall cylinder in product



Order #	Item #	Catalog Price
455-3000	83060-001	\$47.60

kwikset

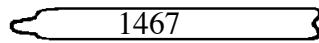
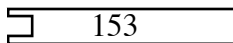

KWIKSET Followers:

455-1065	KWI-153	\$8.12
----------	---------	---------------

Cylinder Removing Tools:

455-1467	KWI-1467	\$1.68
----------	----------	---------------

kwikset

**Installation
Tools**



**138 Installation Kit
includes:**

- A. Quick drill bit adapter
- B. 1" heavy duty Dewalt spade bit
- C. Aluminum template measuring guide
- D. Mortise tools (strike, latch, & 780) with square and round corner blades
- E. Heavy duty it box
- F. 2-1/8" spade bit
- G. In line arm for wood doors
- H. 2-1/8" hole saw for metal and fiberglass doors
- I. 1-1/2" adapter ring
- J. Depth stop Guide
- K. Strike locator
- L. In line arm for metal and fiberglass doors
- M. 1-1/2" multi-spur bit

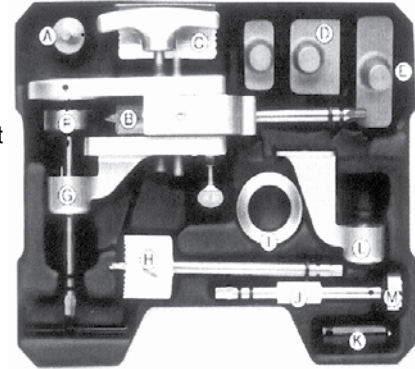

Order #	Item #	Price
455-0138	KWI 138 Kit	\$603.84

Kwikset Keying Kits

Majority of pins are **Color Coded** (pins not color coded are different enough in size to tell apart). Color coding keeps pins from getting mixed. **Anti-Pick Pins** have been added to provide greater security with the Ultra Max Grade 1 Deadbolt. (NOTE: no more than 3 anti-pick pins should be used in one cylinder at a time & only in the first 3 chambers.) Low Profile Deadbolt Spring Cover - used when rekeying Society Brass Low Profile Deadbolt. Kit no longer contains depth keys & Control Key Blanks (rekeying tool)



Order #	Item \$	Price
455-0272	KWI 272	\$235.80

Rekeying Tools

455-7255	21-7615 brass coated, Titan	\$1.28
455-1804	81804 UltraMax Security for Key in Lever	1.62

LOCKSMITH TOOLS

Interchangeable Core Kit (A2)



BFK108

Contents:

- Master/Top Pins: Sizes 2-19
- Bottom Pins: Sizes 0-9
- Spring Caps, 2 Styles, Machined and Stamped
- Spring Covers for 6 & 7 Pin Cores
- 2 Different Length Springs - 108B-Long(Best), 108F-Short(Falcon)
- LKGIC ICore Key Gauge for A2/A3/A4



Features:

- New Tray with Extra Deep Tool Pocket to store your LAB Annex or other large ICore Tools.
- LAB Guaranteed Quality Pins
- Finest Quality Brass Raw material
- Universal Design suitable for all ICore Cylinders that use Brass Key Blanks
- Color-coded for Easy Identification and use

Order #	Item #	Price
465-0580	BFK108	\$225.00

Schlage Kit

SPK115

CONTAINS LAB BRAND ORIGINAL SCHLAGE PINS

Contents:

- Nickel Silver Bottom Pins #0-9: 10 Sizes
- Brass Master Pins #2-9: 8 Sizes
- Brass Top Pins #1-3: 3 Sizes
- Cylinder Cap Pins & Springs
- Cylinder Springs (C503-113)
- "F" Series Top Pins (F506-451)
- "F" Series Compressible Cylinder Springs (F506-453)
- LFT000 Plug Follower for Schlage Cylinders



Features:

- New Layout Chart includes Bitting Information
- Comprehensive Location Chart
- Up to date part identification • Large Capacity Parts Tray
- Extra room for spare parts and tools

Order #	Item #	Price
465-0575	SPK115	\$246.00

Keying Kits

Common Features for, BFK108, KPK115, & SPK115:



- New Wedge Box Design
- Dimensions: 11-13/16" x 8-3/4" x 3-1/2"
- Heavy steel construction with HARDCOAT finish
- Prevents Pin Migration
- Makes kit truly portable
- Seal-tight Cover with Double Latch Protection

Kwikset Kit

KPK115

CONTAINS LAB BRAND ORIGINAL KWIKSET PINS

Contents:

- Brass Bottom Pins: 6 Sizes
- Brass Master Pins: 6 Sizes
- Brass Top Pins: 2 Sizes
- Anti-Pick Top Pins (.160 & .180)
- Stainless Steel Cylinder Springs
- Cylinder Removal Tool



- Plug Follower

Features:

- New Layout Chart includes Bitting Information
- Color-coded Pins • Makes pinning easier
- Complies with New Industry Specifications
- Comprehensive Location Chart
- Up to date part Identification
- Large Capacity Parts Tray
- Extra room for spare parts and tools



Order #	Item #	Price
465-0570	KPK115	\$174.00

LED EAR LIGHT

LABLED.

- Great for picking and wafer reading in low light areas.
- LED high intensity focused beam - vertical and horizontal adjustment.
- Weighs less than one ounce.
- Two replaceable CR-2016 lithium batteries included.
- Comfortable padded universal fit around the ear.



Order #	Item #	Catalog Price
465-0001	LABLED	\$22.50



Keying Kits

Semi Pro Series

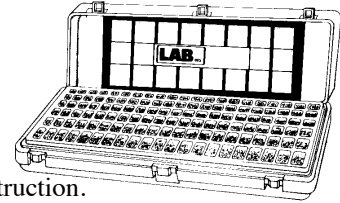

Cylinder Cap Removers. LCR-001

Use short end for Schlage, long end for Weiser-Falcon.

465-0250	LAB-LCR-001	\$60.00
----------	-------------	---------

Mini-Kit Measures
8" x 6"
Ultra thin: 5/8"

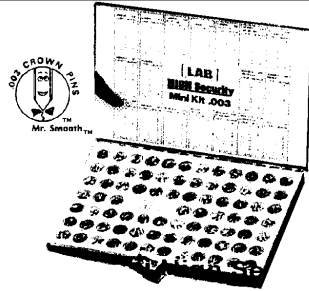

Mini-Kits

.003 Increments. Holds

81 sizes (pins included).

Top: .030 - .090. Bottom Crown: .156 - .333

465-1003	LAB-LMK-003	\$168.00
----------	-------------	----------

.005 Increments. Holds 81 sizes (pins included).

Top: .010 -.200. Bottom: .155 - .360

465-1005	LAB-LMK-005	\$168.00
----------	-------------	----------

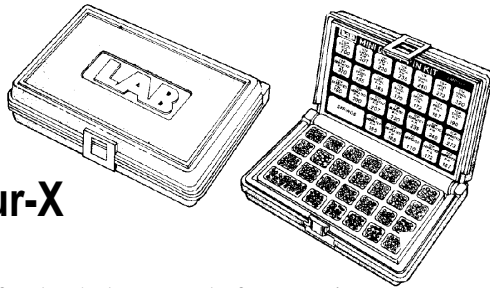

Mini Dur-X Pin Kit

- Super Tuff Polyethylene • Platform Design Insert
- Location Chart • Size: 7.5" x 4.5" x 1.5"
- Includes Springs & Pins (Only original manufacturer's pins)

Item #	Order #	FOR	Price
LMD ACE	465-0555	Ace	\$102.00
LMD WSR	465-0565	Weiser	102.00
LMD KWK	465-0535	Kwikset	102.00
LMD SCH	465-0540	Schlage	102.00
LMD SGT	465-0545	Sargent	102.00
LMD YLE	465-0550	Yale	102.00

Pinning Block

LAB-LPB001. Made of Apple Wood. 5 plug availability. Use with fingers or tweezers.

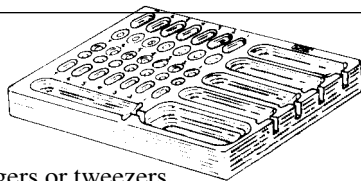

465-0530	LAB LPB001	\$48.00
----------	------------	---------

An excellent in-training pin kit. Polyethylene construction.

LAB-LDKU3, 102 sizes. Semi-Pro .003 Pin Kit

465-0505	LAB-LDKU3	\$270.00
----------	-----------	----------

LAB-LDKZ5 Semi-Pro .005 Pin Kit, 79 sizes.

465-0520	LAB-LDKZ5	\$270.00
----------	-----------	----------

LAB Mini Dur-X Pin Kit

for Repinning Interchangeable Core A2 System

465-0033	LMDICC	\$102.00
----------	--------	----------

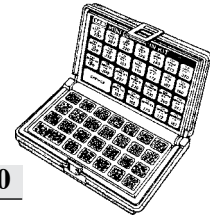

LAB Kit for Schlage and Kwikset Cylinder Repinning Combination Kit In a Metal Box Affordable and Convenient!

Features

Contains only the specific sizes required to service the original Manufacturer's Cylinders. Each Kit is constructed of steel with HARDCOAT finish and Seal-Tight Covers.

Schlage Sizes

- 10 - Nickel Silver Bottom Pins
- 8 - Brass Master Pins
- 3 - Brass Top Pins
- Cylinder Springs



Kwikset Sizes

- 6 - Brass Bottom Pins
- 6 - Brass Master Pins
- 2 - Brass Top Pins
- Cylinder Springs

Order #	Item #	Price
465-2001	LSK2N1	\$240.00

Dur-X Series Professional Pin Kits

Polyethylene construction, lightweight with center handle. Pull out tool drawer. Three double secure latches. Seal tite construction.

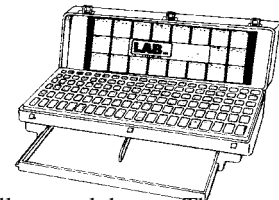

Order #	Item #	Size	# Sizes	Price
465-0510	LDK005	.005	102	\$405.00
465-0525	LDK003	.003	124	\$405.00

LOCKSMITH TOOLS

LAB Emerald WEDGE The Ultimate Pin Kit

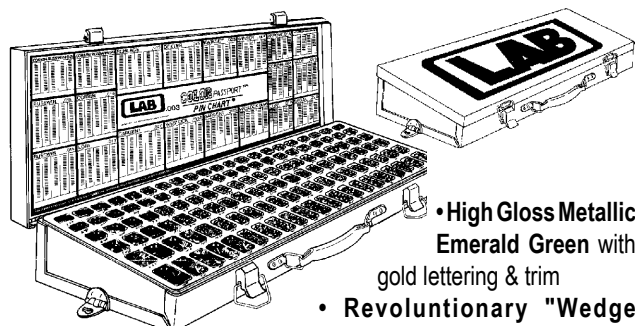

- High Gloss Metallic Emerald Green with gold lettering & trim
- Revolutionary "Wedge Shape" allowing a plain view of all pins from a

- **Color Passport™ Pin Chart** - All numbers are color coded to the corresponding pin size in the clear see-through plastic tray.
 - **Plastic Coated Chart** prevents deterioration and allows locksmith to write on and wipe off any information needed.
 - **Clear Plastic Tray** with new larger numbers inserted underneath for easier reading and long life - they will never wear off.
- "The WEDGE™"** most up-to-date technology for better locksmithing. Consists of a metal box with green metallic finish and gold logo and trim. The box measures 21-1/2" x 7-11/16" with a 10° angle (1-3/4" front and 3 inch back).

EPK 003: 003 increments in 124 sizes, top pins .010 to .200 and bottom pins from .156 to .360.

EPK 005: 005 increments in 102 sizes, top pins .010 to .300 and bottom pins from .150 to .360.

Order #	Item #	Size	Price
465-0605	EPK005	.005	\$345.00
465-0603	EPK003	.003	345.00

Benchmate Wood Line Pin Kits

Master crafted quality construction. Triple latch; Natural full grain wood. Center slide out drawer. Specially designed "Oval" pin pockets for easy finger tip pin selection.

LAB-LWK003 **Woody 3** .003 Pin Kit, 96 sizes.

465-0500	LAB-LWK003	\$510.00
----------	------------	----------

LAB-LWK005 **Woody 5** .005 Pin Kit, 91 sizes.

465-0515	LAB-LWK005	\$510.00
----------	------------	----------

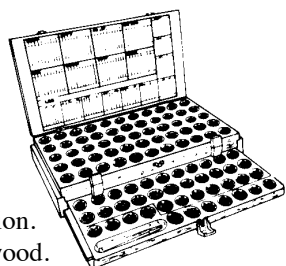

Keying Kits

Super Wedge Pin Box with Tool Drawer

- One Piece solid metal construction
- Tool Drawer • Color Passport® Pin Chart
- Dura-view® pin tray with longlife numbers printed underneath the insert.
- Emerald Wedge Design and Color.
- Pin Block and Vial not included.

Pins Not Included.

Comes without pins to allow you to:

1. Purchase all or only those pins you need.
2. Transfer from your old pin kit(s).
3. Purchase the new LAB Pin Kit Refill Pack

Price: \$330.00 Each

Order #	Item #	Size
465-0003	LAB EPD003	.003
465-0005	LAB EPD005	.005

Pin Kit Refill Pack

.003 Increment pins:
124 packs/50 per pack of LAB tumbler pins.

Tops: 010 - .200; Bottoms: .156 - .360

465-0013	LAB LPP003	\$210.00
----------	------------	----------

.005 increment pins:

102 packs/50 per pack of LAB tumbler pins. Tops: 010 - .300; Bottoms: .150 - .360

465-0015	LAB LPP005	\$ 180.00
----------	------------	-----------

IC CORE SLIDE CHART IC Core Tools

Handy pinning chart (master keying too) for Arrow, Best, Eagle & Falcon interchangeable core cylinders.

465-0247	LSC001	\$34 .00
----------	--------	----------

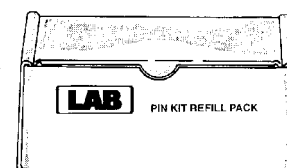
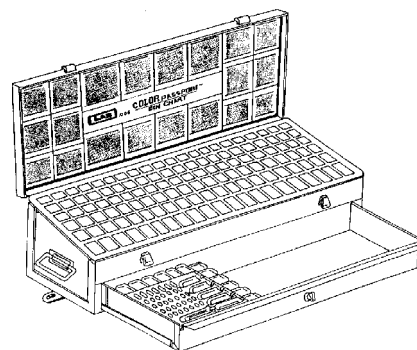



**Medeco®
Pin Decoders**

**Decodes MEDECO®
Biaxial® Pins**

**Identify and Sort, medeco
Biaxial bottom pins according to Length, Angle & Skew**

Medeco Biaxial bottom pins are designed to configure into 36 different positions. Once removed from factory packaging, it is almost impossible to accurately identify the position an individual pin represents.

Additional Features

- Accurately measures/identifies master and driver pin lengths
- Determines key cut depths
- Identifies fore and aft key cut positions

There is no other tool on the market with all of these features! Patent Pending

Order #	Item #	Catalog Price
465-0620	LPDMED	\$108.00

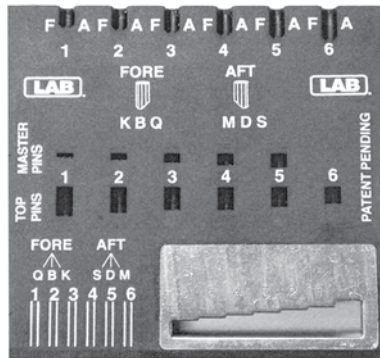

Keying Kits



The Smart WEDGE is Here

**What makes this kit different than
LAB's Universal Pin Kits?**

... Its 40% SMALLER SIZE

Includes:

- 3 Sizes of Spool Pins (J160, J165, J180)
- Schlage "T" Pin for F Series Cylinders
- Schlage "T" Pin Spring for F Series Cylinders
- 2 New Type .115 Long and .115 Short "Tangle Resistant Springs"

Additional Features:

- 40% Smaller Size (21-1/2 x 7-7/8 vs 13-1/4 x 10-1/2)
- Oversized Pin and Spring Pockets - Holds up to 200+ pins per size, 500 springs per size (over double the old capacity)
- Injected Molded Pin Tray
- Famous Patented "Wedge" Design
- Large Tool Pocket
- Large Slid-Out Tool Drawer
- 100% Larger Printing on Pin Tray
- New "Color Passport Pin Chart" - Updated pinning information

Order #	Item #	Cat. Price
465-0610	LSW 003	\$420.00
465-0615	LSW 005	420.00

**ANNEX®
A Superior Inter-
changeable Core
Service Center.**

Offers the simplest method for the loading and unloading of interchangeable core pins, springs and caps, using only one instrument for both functions. A second time saving feature is a Slideout Code Book below the area where the plug or core is slid into place. This allows the user to unload the plug of pins, springs and caps into a confined area without spilling parts in or around the work area. The Slideout Code Book also can be used to retain pin stacks (combinations), allowing you to identify the control pins.

- Capping Instrument
 - Pin-Stack Evictor
 - with Slideout Code Book • Patent pending
- IC Core Tools

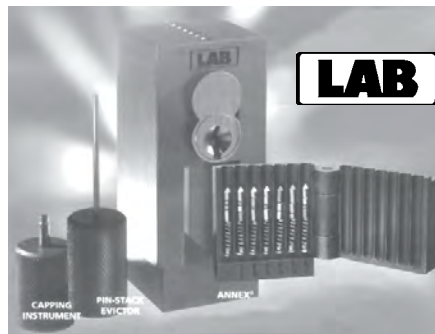

Order #	Item #	Catalog Price
465-4008	LICCB	\$297.00

LOCKSMITH TOOLS



BEST A2 System!

Institutional and Commercial Keying Kits

FEATURES:

- Contains All Original Design Pins for "509" and "552" Plugs
- Brass Top Pins
- Nickel Silver Bottom Pins
- Springs • Caps
- New Large Pocket Design
- Exclusive Wedge Design
- Dual View® Pin Tray
- Comprehensive Pinning Information chart
- SealTight Cover Prevents Pins From Leaking

**LIKCR
Corbin Russwin
System 70 (DH
and Z Class)**



Metallic Chrome Finish

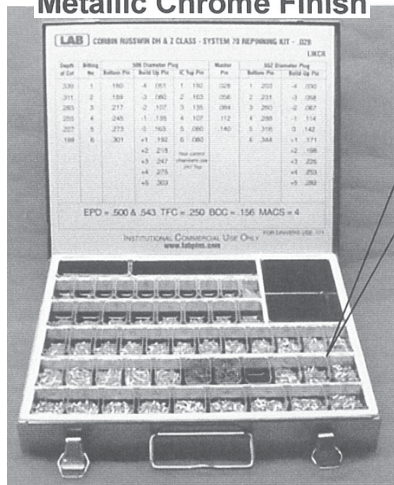

LIKCR Cor/Rus

Interchangeable Core BEST A2 System

Features:

- Contains All Original Design Pins for A-2 System
- Brass Top Pins • Nickel Silver Bottom Pins • Springs • Caps
- Exclusive Wedge Design • New large Pocket Design
- Dual View® Pin Tray • Exploded View Contents Chart
- SealTight Cover Prevents Pins From Leaking
- Top Pins 2B- 19B Brass; Bottom Pins 0A- 9A Nickel Silver

**Designed by and
for Institutional
Locksmiths**

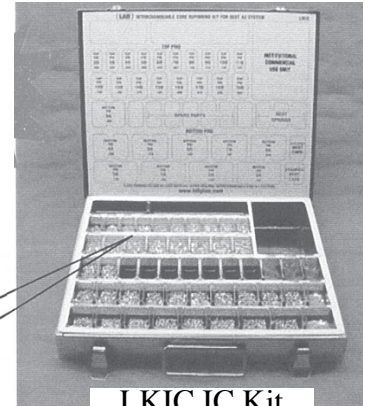

LKIC IC Kit

Dual View® Pin Tray

Pin sizes are enlarged and printed under the clear plastic tray, both above and inside the pin pockets for easy viewing at all angles.

Ordering Information

Order #	Item #	Price
465-0585	LIKCR Cor/Russ	\$375.00
465-0590	LKIC IC Kit	375.00



LAB Universal Classic Pro Pin Kit

.003- Metal Case

LAB Universal Classic Pro Pin Kit- .003- with Metal Case

UNIVERSAL Pins - "The New Standard"

Universal kit, with color coded pins for easy identification. The lid of the generous size kit displays pinning charts, one for each of the most common lock manufacturers.



- 124 Pin Sizes
- 1 Spring size
- Tops: .010 - .200
- Bottoms: .156 - .360



Order #	Item #	Catalog Price
465-0300	LPK003	\$390.00

Casey Tool

Car Opening Tools

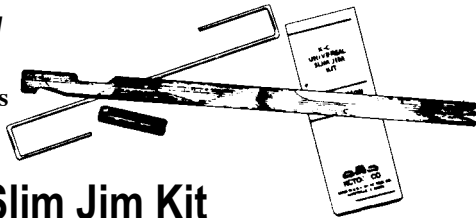

Universal Slim Jim Kit

KC-80. Unlocks over 90% of automotive door locks on the road today. Includes the S-Hook Jim which works on GM, Ford, and foreign door locks with lift buttons. instructions.

427-0008	KC-80	\$20.00
----------	-------	----------------

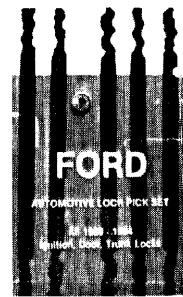

Ford Auto Rocker Lock Pick Sets

Five piece pick set allows easy start-up of ignition, door & trunk locks of all Ford, Lincoln and Mercury models (including vans and trucks) for model years 1969 through 1984. Tempered spring steel. In vinyl case with instructions.

427-0010 (U)	KC-300	\$69.90
--------------	--------	----------------

Automaster Super Lock Pick Sets

A 25 piece automotive super lock pick kit, consisting of five Ford rocker picks, six Chrysler rocker picks, six wafer picks, six new foreign rocker picks, #330 tension wrench, #106 gas cap pick tool. All 25 pieces are made from quality tempered spring steel for long use. Packaged in a custom leatherette case with operating instructions.

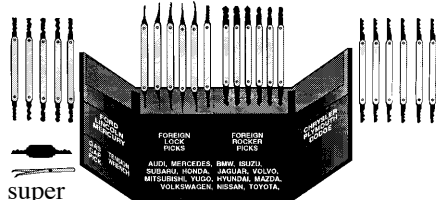

Order #	Item #	Price
427-0340	LOT-340A	\$179.90

Casey Tool Lock Reforming Tools

Fits: GM, Ford, Chrysler and most foreign cars. Tool instantly reforms damaged lock openings to original contours.

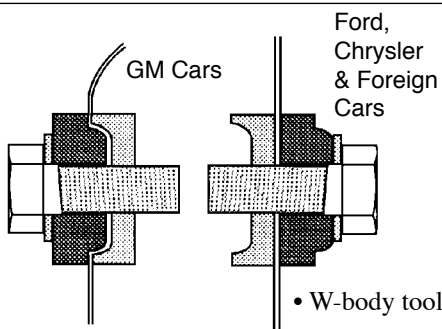

427-0700 (U)	LOT-700	\$69.90
--------------	---------	----------------



Car Opening Tools

Trip Jim. KC101

Works on all models of Ford vans & Dodge pickups. Also on: Porsche, Datsun, AMC, Honda, Mercedes, Saab, Volvo, BMW, Renault, Toyota, Ford, VW, GM, Chrysler.

427-0004 (U)	KC-101	\$11.00
--------------	--------	----------------

LCN

ADA Accessibility Force Guages

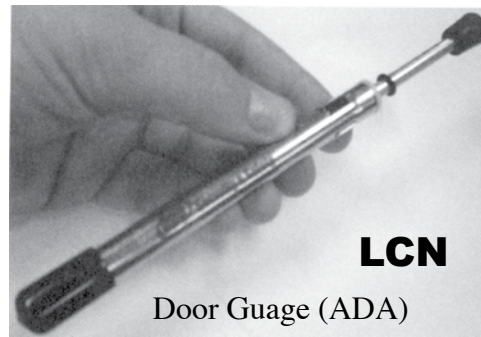

Door Gauge (ADA)

A reference tool that can be used to measure the opening and closing force on door openings in order to meet ADA requirements.

- Up to 35 lbs of compressive force measurement makes it suitable for a wide range of applications
- Compact Size makes it easy to store and transport - can be put in a tool box, desk drawer, or a shirt pocket.
- Quick measurement - takes only seconds per door.
- Cost-effective • Device is for reference only.

Includes: ADA Accessibility Gauge, Protective clear plastic tube with plastic end cap, Instruction sheet.

Order #	Item #	Catalog Price
460-1000	LCN ADA/FG	\$82.60

LOCKSMITH TOOLS



HIT-48 Series Carbide Tipped Hole Saws



Tired of drilling wood doors with hole saws designed for drilling steel? Tired of backing the hole saw out and cleaning the teeth? Then try the HIT-48 series hole saws designed to drill wood. The three carbide teeth will not gum or load up and are clean cutting. Hole saws can be used on your existing commercial type mandrel if the 1/4" diameter pilot bit is changed out to a longer one, see part # HIT-48-300, or just use with our mandrel.

**THESE HOLE SAWS ARE FOR WOOD ONLY!
NOT FOR USE ON STEEL.**

HIT-48-100

Three tooth 1" diameter carbide tipped hole saw designed for wood and fiberglass doors. Requires a mandrel with a longer than normal pilot bit. Use mandrel # HIT-48-310.

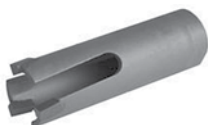

Order #	Item #	Catalog Price
527-0320	HIT-48-100	\$22.50

HIT-48-114

Three tooth 1-1/4" diameter carbide tipped hole saw designed for wood and fiberglass doors. Requires a mandrel with a longer than normal pilot bit. Use mandrel # HIT-48-320.



527-0325	HIT-48-114	\$25.00
----------	------------	----------------

HIT-48-138

Three tooth 1-3/8" diameter carbide tipped hole saw designed for wood & fiberglass doors. Requires a mandrel with a longer than normal pilot bit. Use mandrel # HIT-48-320.



527-0330	HIT-48-138	\$27.00
----------	------------	----------------

HIT-48-112

Three tooth 1-1/2" carbide tipped hole saw designed for wood and fiberglass doors. Requires a mandrel with a longer than normal pilot bit. Use mandrel # HIT-48-320.



527-0335	HIT-48-112	\$29.50
----------	------------	----------------

HIT-48-218

Three tooth 2-1/8" carbide tipped hole saw designed for wood and fiberglass doors. Requires a mandrel with a longer than normal pilot bit. Use mandrel # HIT-48-320.



527-0340	HIT-48-218	\$37.50
----------	------------	----------------

HIT-48-300

Replacement 1/4" diameter pilot bit. Drill Bits



Order #	Item #	Catalog Price
527-0345	HIT-48-300	\$6.50

HIT-48-310

Mandrel for use with our 1" diameter hole saw.



527-0350	HIT-48-310	\$31.00
----------	------------	----------------

HIT-48-320

Mandrel for use with our 1-1/4" and larger hole saws.



527-0355	HIT-48-320	\$43.00
----------	------------	----------------

MORSE

**MORSE
Hole Saws**

TAD03L Locksmiths Hole Saw Kit

Contents:
Four PD4 pilot drills.
One each of the following:
TAD12 (3/4");
TAD14 (7/8");
TAD16 (1");
TAD22 (1-3/8");
TAD24 (1-1/2");

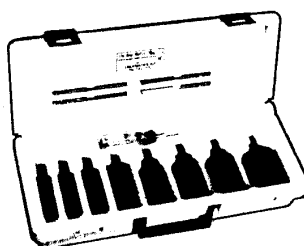

TAD26 (1-5/8");
TAD28 (1-3/4");
TAD34 (2-1/8")
SD10 (Screwdriver)

The Original High Speed Steel, Deep Hole Saw with Built-In Arbor

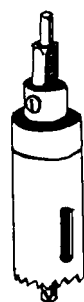

Order #	Item #	Price	Size
590-0004	PD-4	\$6.92	Pilot Drill
590-0012	TAD12	27.04	3/4"
590-0014	TAD14	27.04	7/8"
590-0015	TAD15	27.04	15/16"
590-0016	TAD16	28.32	1"
590-0018	TAD18	28.32	1-1/8"
590-0024	TAD24	30.88	1-1/2"
590-0026	TAD26	30.88	1-5/8"
590-0034	TAD34	46.98	2-1/8"

590-0030	TAD03L KIT	\$337.46
----------	------------	-----------------

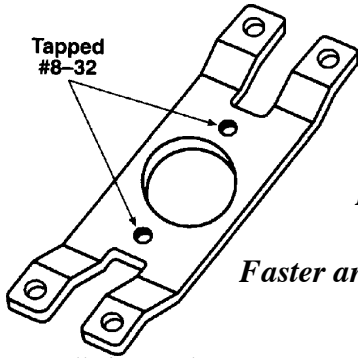

Major
MANUFACTURING, INC.



Install Cylindrical Knob Locks or Deadbolts on Metal Doors Faster and Easier Than Ever!
Lock Mounting Brackets

Installation Tools

Stamped from 12 gauge cold rolled steel for strength, installed with pop-rivets for convenience, and supplied with an adhesive template for accuracy. Cut out in the center to allow installations on metal doors with a center seam. Marked for 1 and 1-1/8" faceplate cutouts as well as for bracket mounting holes and center lines to locate the crossbore. Complete with template and steel pop-rivets.

Order #	Item #	Price
527-0240	MAJ LMB-01	\$10.50

Major Manufacturing, Inc

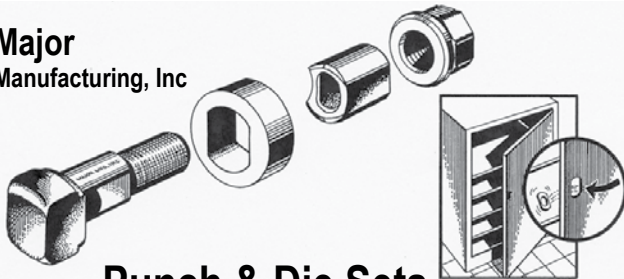

Punch & Die Sets

Punches a DOUBLE "D" hole in sheet metal cabinet drawers and doors. A must have tool for the locksmith working on vending machines, lockers, metal cabinets or any type of sheet metal door made with 18 gauge (.048) or lighter steel. To use, simply drill a 3/8" hole centered where the cam lock is to be installed, slide the punch through the hole and tighten down the hex nub with a 11/16" wrench. Punches a DOUBLE "D" hole size .645 wide by .770 high.

Order #	Item #	Catalog Price
527-0305	MDPS-4	\$252.50

Shim Stock

SS-25.

Flexible but tensile strength prevents creasing when shimming lock cylinder. Rustproof stainless steel, curved to conform to shape of lock plugs. 25/pk

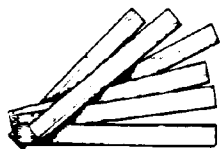

Order #	Item #	Price
245-0028	SS-25	\$8.50

A Combination Tool

SCT-3 Plug Followers

Combines a plug follower with a master wafer removing feature and a pin depressor.

Follower can be used on most cylinders with standard diameter plugs. Especially suited to be used on Schlage cylinders or any cylinder using a cylinder cap retained with a spring loaded pin. Simply depress the pin, remove the cap, turn the tool around and use as a standard follower. As an added feature, the pin depressor may be removed allowing the use of both ends of the follower when loading cylinder springs. Special grooves machined in the follower will also allow it to be used on Sargent 8 line cylinders and Almont Padlocks.

Order #	Item #	Price
527-0255	MAJ SCT-3	\$46.50

High Intensity Light Where You Need It!

Lighting Tools

Fiber Optic Attachment

A Handy Tool That Makes Jobs Easier.

Installs by simply sliding the rubber boot over the end of your mini-flashlight. Adjustable focus from flashlight will vary light intensity. No bulbs to burn out or break. Fits most AA aluminum flashlights. Available in two lengths.

Order #	Item #	Length	Price
527-0165	MAJ FOA-20	20"	\$36.50
527-0170	MAJ FOA-7	7"	27.50

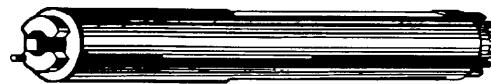

Makes a Frustrating Job Easier and Faster

Schlage Service Tool

Quickly service Schlage locks.

Side "A" will easily remove the threaded cap from Schlage cylinders including the new "B" series with the longer cam driver. The "B" side is used to depress the cylinder cap pin and turn the tailpiece on Schlage "A" series locks so the knob retainer can be depressed, and the knob removed. This method is used when a key is not available.

Order #	Item #	Price
527-0250	MAJ SCT-1	\$46.50

LOCKSMITH TOOLS



SPECIALTY Installation Tools

Every Installation is a Self-Portrait of the Person Who Did It. Autograph Your Work with Excellence.

For New Installation or to Redrill Misaligned Cylinder Holes!

Mortise Cylinder Tool

Until now, installing a mortise cylinder in the proper location was a hit or miss proposition. The HIT-22, it will always be in the right spot. Simply mark where the cylinder should go on the door and drill a 1/2" hole. Place the HIT-22 in the lock like a mortise cylinder, tighten the mounting screw and install the lock in the door. You will see the guide through the 1/2" hole in the door. Insert a 1-1/4" hole saw in the guide and drill the cylinder hole. A perfect installation or redrill every time. Includes

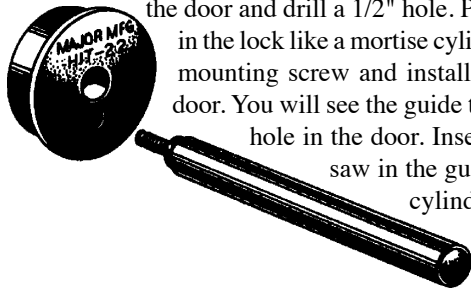

two drill guides, hole saw pilot and extractor handle.

Order #	Item #	Price
527-0175	MAJ HIT-22	\$78.00

MULTI-PURPOSE NUT DRIVER

Companion tool to HIT-1. Provides better grip & control when tightening the locking nut on the inside sleeve, than the plastic tool provided by the manufacturer. Machined Aluminum.

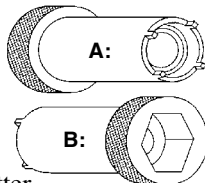

A: This end for Schlage Rhodes

B: This end for Assa Brooklyn, Arrow Sierra, Sargent LN.

Order #	Item #	Price
527-0002	HIT-2	\$55.00

Used to retrofit wooden and metal doors to accept cylindrical lever locks by Assa, Arrow, Sargent, Schlage, Corbin, Russwin & More!

INSTALLATION GUIDE/TEMPLATE

An all-around tool for ADA mandated retrofits.

Fits 1-3/8" to 2" doors with a standard 2-3/4" backset. Machined from 6061 aluminum with hardened steel drill guides.

Throughbolts can be drilled in one easy step because HIT's backplate protects the door from splintering.

Jig attaches to the door and permits easy location of all drill points; the throughbolt holes and anchor plate lugs can then be quickly and accurately drilled, sparing the usual laborious measuring and recalculating of hole locations.

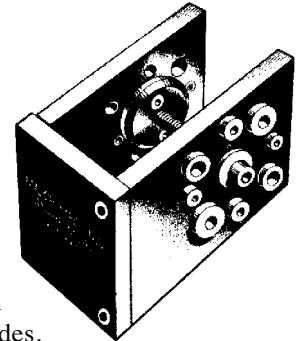

Order #	Item #	Price
527-0001	MAJ-HIT-111	\$389.50

1. MARK 2. CLAMP 3. DRILL

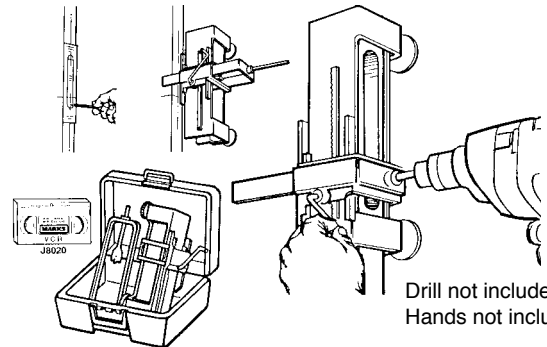

Drill not included. Hands not included.

SPEED MORTISER Mortise Lock Installation Tool

Prepares required mortise cavity using a series of drilled plunge cuts followed by several up and down cleanup passes with the drill bit. Fully adjustable for mortise height. Designed to self center on 1-3/8" and 1-3/4" doors. Shipped in a plastic carrying case with a 1" bit standard. Requires a 1/4" or larger electric drill. • Simplifies mortise lock installation.

- Professionally prepares mortise cavity.
 - Adjustable for any mortise lock.
 - Mortise depth can be adjusted.
 - Portable.

Order #	Item #	Price
540-8000	HIT-38	\$675.00



Installation Tools

**HIT-45. MODULAR
INSTALLATION SYSTEM
FOR DOOR HARDWARE**

HIT-45 CLAMP

At the center of this new installation system is the HIT-45 modular clamp.

Works on aluminum, wooden or hollow metal doors. Has a grip range from 1-1/4" to over 2-1/4". Clamping pressure is positive with the HIT-45 always being self centering by design. Works with any router or drill template shown.

Perfect backset calculated from center of door for FLAT, BEVELED, RADIUS.

Order #	Item #	Price
527-0185	MAJ HIT-45	\$466.50

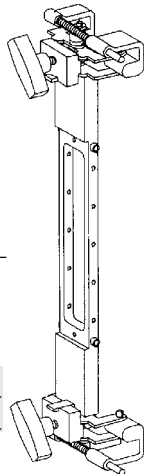

CHOOSE ACCESSORIES FROM THE FOLLOWING:

HIT-45AR1

Use this template and HIT-45 Clamp to route 1" x 6-7/8" faceplate openings used for Adams Rite locks and Latches.

Requires use of router equipped with 3/8" outside diameter guide and a 1/4" router bit.

Order #	Item #	Price
527-0190	MAJ HIT-45AR1	\$73.50



HIT-41 Series

Template for Installing Electric Strike in Aluminum Doors & Frames

Used to install Adams Rite 7100 Series 4-7/8" ASA Strike. Requires a router with a 3/8" outside diameter guide & a 1/4" router bit.

Order #	Item #	Price
527-0180	MAJ HIT-41AR1	\$277.50

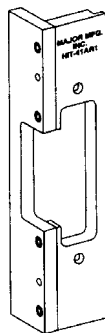

HIT-45AR4

Route cylinder and handle or paddle holes for Adams Rite locks and latches with a 31/32" or 1-1/8" backset. Will also locate mounting holes for handles and paddles with hardened drill bushings.

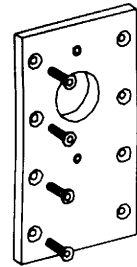

Requires HIT-45 Clamp and router equipped with 3/8" outside diameter guide and 1/4" router bit.

Order #	Item #	Price
527-0205	MAJ HIT-45AR4	\$163.00

HIT-45ML1

Two piece positioning fixture used when installing mortise locks. Using this tool will put the HIT-45 Clamp in the correct location and will assure accurate installations every time.

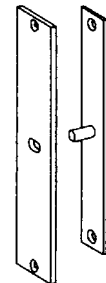

Order #	Item #	Price
527-0210	MAJ HIT-45ML1	\$132.50

Used with the HIT-45SL1 below:

HIT-45SL1

Makes short work when installing Schlage L locks. All holes needed for cylinders, posts, spindles, etc., are located with hardened drill bushings. Larger holes are first located and drilled with a 1/4" diameter hole. This hole serves as a pilot for the correct size hole saw.

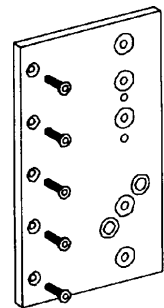

All hole locations on template are identified for use. Requires HIT-45 Clamp with HIT-45ML1 Locator.

Order #	Item #	Price
527-0220	(U) MAJ HIT-45SL1	\$292.50

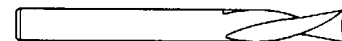

Router Bits

Special Titanium Coated 1/4" Down Shear Router Bit is used to route openings in aluminum doors and frames.

Order #	Item #	Price
527-0215	MAJ HIT-45RB1	\$41.50

LOCKSMITH TOOLS



Installation Tools

Drill Guide for Schlage Cobra

Accurately install Schlage Cobra pushbutton locks using the HIT-117 drill guide. This unit thru-bolts to the door using the existing 2-1/8" crossbore for alignment. All required mounting and function holes are located with hardened drill bushings on both sides of the template to allow drilling from either side of the door. Standard drill guide will accommodate doors up to 2" thick.

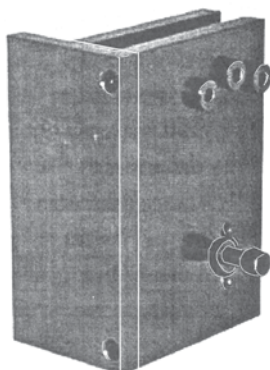

Order #	Item #	Catalog Price
527-0310	HIT 117	\$389.50

Drill Guide for Locknetics Computer Managed Cylindrical Lock CMC 5100 Series (New Style)

Installing the Locknetics CMC 5100 series is quick and accurate when using the HIT-103N. This unit thru-bolts to the door using the existing 2-1/8" crossbore for alignment and the required holes are located with hardened drill bushings. HIT-103N has drill bushings on both front and back plates to allow drilling from either side of door. Standard unit will accommodate doors up to 2" thick.

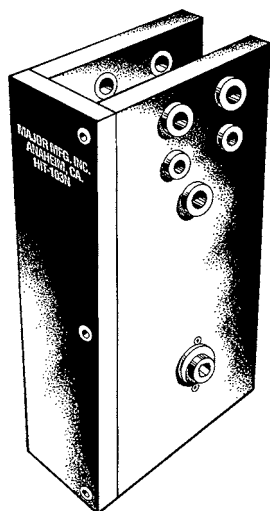

Order #	Item #	Catalog Price
527-0315	HIT-103N	\$389.50

Pit-Bull Mortising Tool for Hollow Metal Steel Doors.

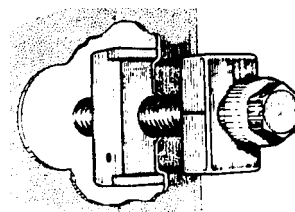

With Pit Bull (formerly Squeeze-Play), the installation of a standard 2-1/2" x 1" or 1-1/8" faceplate for dead bolt and cylindrical locks in most hollow metal steel doors is fast and easy.

602-0900	MDLT-1	\$315.00
----------	--------	-----------------

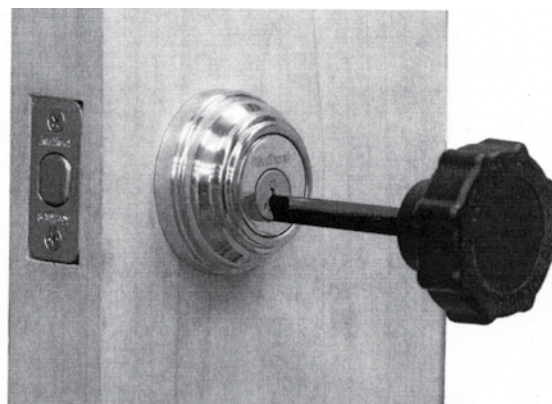

KTT-3 KWIK Torque Tool for Opening Kwikset® Smart Key™ Locks

Quickly open the Smart Key lock with the use of our KTT-3 Kwik Torque Tool. What could be easier or faster; just insert the tool in the keyway and turn. The lock will be opened in seconds! The only damage to the lock is the loss of the Smart Change Feature, in most cases the original keys will still work.

This tool sold only through locksmith distributors.

Order #	Item #	Catalog Price
527-0360	KTT-3	\$149.00

COMPX National

CompX/National Keying Kits

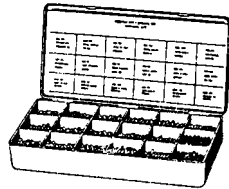

V70P-1 Pin Tumbler Kit.

- 100 pcs. ea. 1, 2, 3 & 4 drivers.
- 100 pcs. ea. 0, 1, 2, 3, 4, 5, 6, 7, 8 & 9 tumblers.
- 250 pcs. tumbler springs.
- 100 pcs. tumbler retainers.
- 50 pcs. ea. C3735 & C3738 plug retainers.

605-4150	V70P	\$153.86
----------	------	----------

V70P-2. Pin Tumbler Masterkeying Kit.

- 100 pcs. ea. 2, 3, 4, 5, 6, 7 & 8 master drivers.

605-4155	V70P-2	\$44.02
----------	--------	---------

V71D-3 Disc Tumbler Keying Kit.

- 100 pcs. ea. 00, 22, 44, & 66 tumblers. 250 pcs tumbler springs.

605-4160	V71D	\$33.90
----------	------	---------

V71D-4. Disc Tumbler Masterkeying Kit.

- 100 pcs. ea 02,04, 06, 20, 26, 40, 42, 46, 60, 62 & 64 tumblers.
- 250 pcs tumbler springs.

605-4165	V71D	\$67.24
----------	------	---------

PRG (Hudson)

Programmed Marketing (Hudson)



Wafer Keying Kits. PRG-KIT

Universal kit for non master keyed Hudson wafer locks

685-0001	PRG-KIT	\$133.34
----------	---------	----------



KEYING KITS

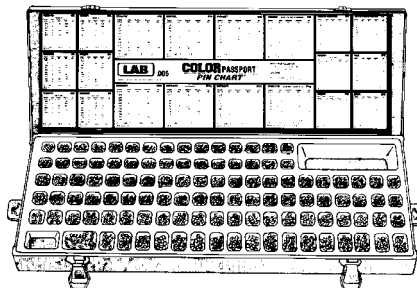

Plastic Coated Passport™ protects your chart from being soiled or worn. Can be written on with non-permanent marker and erased. Pin numbers on the chart are color-coded to match the actual color of the pin in the kit.

Hard Coat™ is a new metallic green paint that provides the best protective finish available.

Dura View™ Pin Tray is clear heavy-duty with larger print numbers that will never wear out.

Pin Tolerances. provides the "closest tolerance" Universal .005 or .003 pins manufactured.

Easy access pin compartments all on one level.

.003: Top pins .010 - .200 • Bottom pins .156 - .360

.005: Top pins .010 - .300 • Bottom pins .150 - .360

Order #	Pin Increments	Price
845-1005	.005	\$258.00
845-1003	.003	\$258.00

Standard Wafer Cam Lock Keying Kits.



SOU-S-SLK-401

845-0401	SLK-401	\$38.70
----------	---------	---------

LOCKSMITH TOOLS

Hurricane Door Upgrade Kits

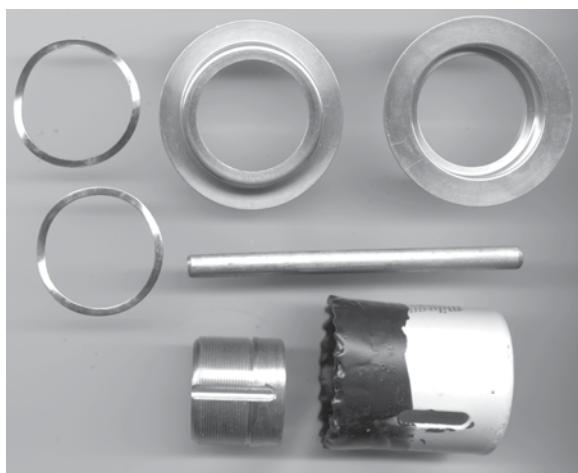

Allows you to maintain a key system without having to buy the more expensive 1-1/2" mortise cylinders.

Enlarge the size of the cross bore just enough for the ring to fit in the frame and the face of your cylinder will be just below the surface of the frame.

Works with Medeco and Schlage Primus/Everest cylinders.

Kit includes:

- Two cylinder rings
- Two wavy rings
- 1-9/16" hole saw
- 1/4" smooth Pilot bit
- Blank cylinder, predrilled

Order #	Item #	Catalog Price
845-8000	Hurricane Upgrade Kit	\$99.90

Hurricane Door Upgrade Rings

Two cylinder rings and two wavy rings.

Once you own the Upgrade Kit, just buy the extra rings.

Order #	Item #	Catalog Price
845-9000	Hurricane Upgrade Rings	\$50.00

TUNGSTEN CARBIDE Hole Saws - HG SERIES

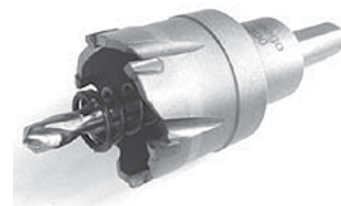

Product Overview

- This Hole Saw can easily and quickly perforate hard materials up to 3/16 inches.
- With its extremely sharp Tungsten Carbide tipped cutting edges it can be run at higher feed rates and speeds to create holes of exceptional quality and accuracy.
- The slug is spring ejected when cutting is finished.
- This type hole saw can be used on drill presses and electric hand drills.

Applications

- Stainless steel
- alloy steel
- iron
- copper
- aluminum
- brass
- F.R.P.

Ideal for:

- Locksmiths
- Plumbers
- Electricians
- Contractors

Order #	Item #	Size	Catalog Price
845-6050	HG602540	1"	\$48.00
845-6060	HG605398	2-1/8"	100.20

Template for installing Detex Alarms

845-7000	DET-5000	\$39.98
----------	----------	----------------



Similar to one pictured

Locksmith WOOD Chisels

1-1/8" high quality wood chisel, perfect for door lock installation.

845-4000	JBM CH118	\$29.98
----------	-----------	----------------

PRO-LOK

Padlock Drill Jigs



1. Clamp Padlock Drill Jig around the padlock. The exact 'X' alignment depth is specified on a chart that comes with the unit.
2. Drill on the centerline of the lock edge at 'X' (dimension listed on the chart).
3. The drilled hole is then tapped to 8-32. A brass or aluminum screw is inserted with Loctite™, cut off and filed smooth. The padlock is now ready for reinsertion of the serviced cylinder.

Padlock Drill Jig Guide

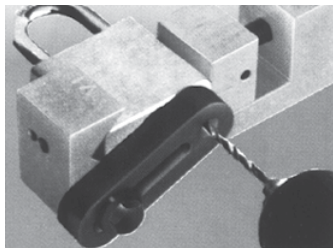

Used with the LT612.

1. Prior to clamping the jig in place, the face of the hardened oval nut is ground with a small abrasive wheel, ball or disc, breaking through the case-hardening.
2. Clamp Padlock Drill Jig around padlock and tighten vise to secure. Next, the drill guide is aligned until it is centered on oval nut, then it is tightened, locking it in place.
3. Drill out nut center post permitting you to open, remove, and service cylinder. Reuse lock by replacing nut.

Did you ever try to drill open a padlock while holding it steady with your other hand? Did it hurt?

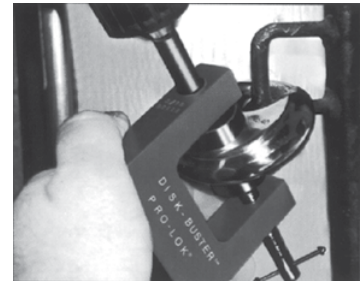

Disk Buster

Disk Buster™ is a drilling fixture for various brands & models of standard diameter disk-style padlocks. Small pin size and close proximity of the spacing increments makes disk-style padlocks difficult to pick or impression.

PRO-LOK Disk Padlock Drill makes this task easy.

1. **Position the Disk Buster.** Clamp the padlock so that the cylinder area is centered inside the alignment cup. This centers shear line.
2. **Drill the Shear Line.** Grip vise, holding whole assembly steady. Use your drill bit with the supplied stop collar and drill the plug.
3. **Turn the Plug.** After cylinder has been drilled, simply remove Disk Buster, turn the plug with a small pocket screwdriver. This draws the shackle into the body.

Ordering Information:

Order #	Item #	Description	PRICE
684-0615	LT605	Disk Buster	\$97.80
684-0620	LT612	Padlock Drill Jig	97.80
684-0625	LT612DG	Padlock Drill Jig Guide	32.60

Auto Opening Kits

AKLM98 Late Model Tool Kit

Don't be intimidated by new vehicles. The right tool makes your job easier. **29 piece** kit for late model vehicles. Contains all of the tools used in the PRO-LOK Car Opening Manual Volume 3 (1995, 1996, 1997) and those tools used in our 1998 update. Comes in a deluxe case with a tool instruction booklet.

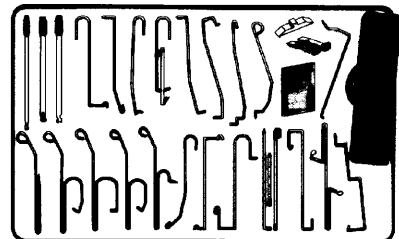

AKCOM98

AKCOM98 Complete Tool Kit

Never be without the right tool again. Kit contains every tool you could possibly need. The right tool makes your job easier. **43 piece** kit contains 1 of each of PRO-LOK tools and a selection of wedges in a deluxe case with a tool instruction booklet.

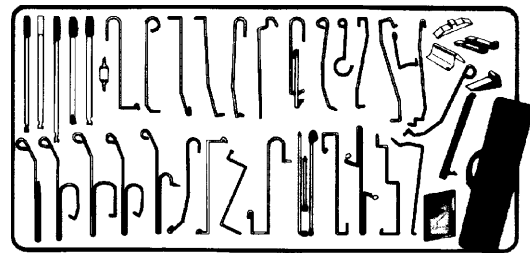

AKLM98

30% Savings Over Purchasing Individual Tools!

Order #	Item #	Price
684-0021	AKLM98	\$592.40
684-0022	AKCOM98	802.20

LOCKSMITH TOOLS

Car Opening Tools

Slide Lock Tool

Two tools in one. Opens both horizontal locking devices & vertical buttons.

684-0105 - A001 **\$31.40**



**AO-01
Slide Lock Tool**

Gas Cap Key

Use this tool to open almost any locked gas cap. Use tool like a pick.

684-0110 A004 **\$11.20**



**AO-04
Gas Cap Key**

Astro Tool

Opens Chevy Astro Van; several GM cars. The hook and reach make this tool extremely useful.

684-0115 A007 **\$19.20**



**AO-07
Astro Tool**

Original Slim Jim

This is the Original Slim Jim and still the best. Stainless steel.

684-0120 A010 **\$18.40**

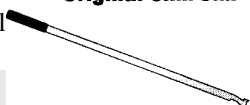

**AO-10
Original Slim Jim**

Super Slim Jim

Wider and thicker than the original. Opens many foreign and domestic vehicles. Stainless steel.

684-0125 A011 **\$19.40**



**AO-11
Super Slim Jim**

Under the Handle Tool

Used to push horizontal and vertical linkages accessed behind "pull up" type handles.

684-0130 A013 **\$19.20**



**AO-13
Under the Handle Tool**

Vent Window Mini Set

Operate the vent windows on car, truck and van doors. With 2 tools.

684-0135 A014 **\$20.80**

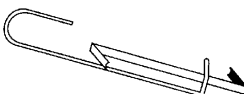

**AO-14
Vent Window Mini Set**

Toyota Tool

Perfect for opening the newer Toyotas with the metal boxes guarding the bellcrank.

684-0145 A021 **\$27.80**

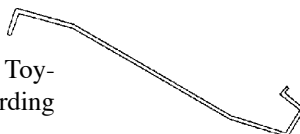

Dual Tool

Two tools in one. Opens many types of foreign & domestic vehicles like the Mazda RX7 & Subaru.

684-0155 A029 **\$27.80**



**AO-29
Dual Tool**

X-Long Slim Jim

Be able to reach even the deepest linkages. Just like the original, only longer. Stainless steel.

684-0160 A030 **\$20.00**



**AO-30
X-Long Slim Jim**

Separator Tool

Allows entry of the "under the window tool", where the inner panel deflector prevents entry.

684-0165 A033 **\$27.80**

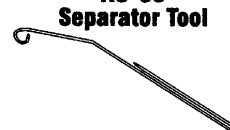

**AO-33
Separator Tool**

MCOT Tool

The original Multi-Car Opening Tool. Goes under the window and inside to open the door.

684-0170 A034 **\$27.80**



**AO-34
MCOT Tool**

MCOT Wide

Use on cars with wide door panels and cars where you push or pull.

684-0175 A035 **\$27.80**

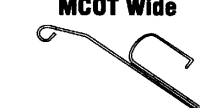

**AO-35
MCOT Wide**

MCOT Long

The longest MCOT allows maximum reach. Use on GM & other products.

684-0180 A036 **\$27.80**



**AO-36
MCOT Long**

Button Finger Tool

The original MCOT modified to operate vertical button cars. Works on many Toyotas and other imports.

684-0185 A037 **\$27.80**



**AO-37
Button Finger Tool**

Clear View System

3 piece wedge system designed to hold back the weather stripping and give maximum visibility.

684-0225 A063 **\$41.60**



**AO-63
Clear View System**

Car Opening Tools

Honda Tool

Used to open all '93 and '94 Hondas and a number of other foreign and domestic vehicles.

684-0190	A038	\$27.80
----------	------	---------

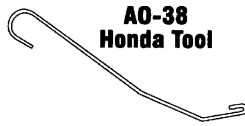

**AO-38
Honda Tool**

GM "L" Tool

Designed to gain quick entry into large bodied GM cars such as the Buick Park Avenue & Pontiac Bonneville.

684-0195	A040	\$27.80
----------	------	---------



**AO-40
GM "L" Tool**

Behind the Glass Tool

Solves the problem of gaining access to horizontal rods located above & behind the window.

684-0545	A041	\$27.80
----------	------	---------

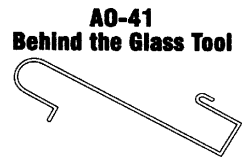

**AO-41
Behind the Glass Tool**

Long Reach Tool

Across-the-car entry tool. Allows to reach an activator on opposite door or retrieve the keys.

684-0205	A042	\$56.20
----------	------	---------



**AO-42
Long Reach Tool**

Double Sided Wedge

Made of high impact plastic. Different height on each side allows you to adjust to doors with varying flexibilities.

684-0215	A060	\$13.40
----------	------	---------



**AO-60
Double Sided Wedge**

HD Rubber Wedge

Made of heavy-duty non-marking high grade rubber.

684-0220	A061	\$23.60
----------	------	---------



**AO-61
HD Rubber Wedge**

Cap Clincher

Provides quick replacement of GM and other auto lock caps. Simply place the cap in the tool, position the lock, & squeeze to clinch the cap into place. Won't scratch surface of caps.

684-0440	LT740	\$62.80
----------	-------	---------



Mini Wedge Duo

These plastic Wedges make wedging even tight doors easy.

684-0230	A064	\$18.40
----------	------	---------



**AO-64
Mini Wedge Duo**

Euro Strip

Flexible tool allows you to bypass doors on Mercedes, BMW, & Volvo.

684-0235	A085	\$36.20
----------	------	---------



**AO-85
Euro Strip**

Mini Tech Manual

Resource book for understanding different auto locking systems & the tools needed to open them.

684-0240	A095	\$29.90
----------	------	---------



**AO-95
Mini Tech Manual**

Deluxe Auto Opening Kits for Any Situation

Highest Quality Materials, Stainless steel Slim Jims; Small Diameter for Easy Insertion, Zinc Plated to Resist Corrosion, MCOT Tools Feature Rubber Tips.

The Professional Kit

If you are outfitting a van, or need a spare kit for the shop, the AK04 is perfect. Tools included are 2 Slim-Jims, Slide Lock tool, 2 MCOT tools, a wedge, a gas cap key, Slide Jim, and the mini-tech manual. This is a basic 10 pc kit with the most requested tools included. 8" vinyl pouch for storage.

684-0005	AK04	\$141.20
----------	------	----------

The Premium Kit

14 of Pro-Lok's best sellers combined into a money-saving kit. This kit will allow you to open 98% of the cars in the Auto Opening Manuals. Features a heavy duty cloth pouch with custom compartments for each tool.

684-0025	AK92	\$340.80
----------	------	----------

Cap Clincher

Provides quick replacement of GM and other auto lock caps. Simply place the cap in the tool, position the lock, & squeeze to clinch the cap into place. Won't scratch surface of caps.

684-0440	LT740	\$62.80
----------	-------	---------

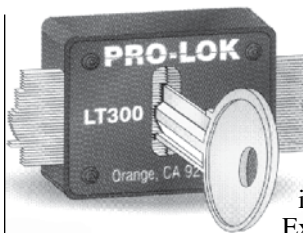

The Keycheck

Find the Right Blank Everytime!

Allows you to verify that you are duplicating a customer's key on the correct blank. Great for determining those difficult sectional keyways.

Excellent tool for new employees or those who are not expert at the key

board. Saves wasted work and dissatisfied customers.

684-0380	LT300	\$78.80
----------	-------	---------

LOCKSMITH TOOLS

Bushing Plates for Killer Jig

Replacement part for INJIG-KJ.
This set of 2 hardened plates are
used for locks requiring a cross
bore of 1-1/2" or 2-1/8".



Order #	Item #	Size	Dealer Price
684-0305	INJIG-124	1-1/2"	\$29.90
684-0310	INJIG-126	2-1/8"	29.90

TEMPLATES

Installation Tools

Lightning Fast Lock Installations
with the IN Series Hardware Templates.

Universal Clamp

The cornerstone of the Professional Installation Series. Holds all of the specialty templates without damage to the door's finish. Fabricated in milled aluminum. Complete with an easy to use 1.5" sure-grip knob for quick and positive hand tightening.

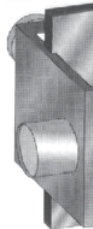

684-0260	INCL	\$150.00
----------	------	-----------------



IN 10 - Simplex 1000

Preps Simplex 1000 Series locks. Use with INCL Universal Clamp (sold separately).

684-0250	IN10	\$147.80
----------	------	-----------------

PRO-LOK

NEW

INBIT Router Bits

Use for installing the popular Von Duprin 99 series exit devices. Works with a plunge router and is perfect for installation on wood door applications.



Order #	Item #	Dealer Price
684-0300	INBIT	\$156.00

PRO-LOK

Stainless Steel Key Decoders

Decode cut depths on the most popular keys. Use for rekeying and code cutting. Uses stepped depths for exact decoding. **\$35.90 Each**



684-0265	KD01	Schlage, Kwikset Weiser, Weslock
684-0270	KD02	Medeco, Master American
684-0275	KD03	GM, Ford, Chrysler Ford 10 cut

Commercial/
Residential

Auto

Blank

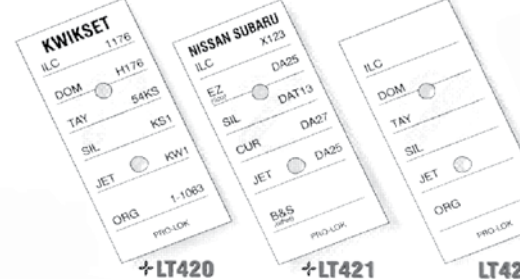

Key Tag System

Organize & identify your key blanks easily. The key tags go behind the hooks on your keyboard and allow you to quickly and easily identify your key blanks. Over 800 tags in the LT420. Over 700 in the LT421, and 96 tags in the LT422.

* Preprinted with hundreds of the most popular blanks.

Order #	Item #	Tags	
684-0390	LT420*	Domestic	\$87.40
684-0395	LT421*	Auto Key	87.40
684-0400	LT422	Blank (make your own)	17.60

Key Tag Systems

LOCKSMITH TOOLS PRO-LOK

TOOLS

HARDBODY

Car Opening Lights

Made from machined aluminum, they are lightweight and versatile. The Hardbody is turned on through a connection from the end of the wand to the head of the body. Connect the Hardbody and it's on. Comes with a carrying case, a suction cup clip - to hold it steady against the window, and a translucent sleeve bulb protector. Complete with a Lifetime Warranty (excluding bulb)



684-0035	AL10500	2 AA-Cell Broad Spectrum Bulb	\$73.40
684-0060	AL15500	3 AA-Cell Krypton Bulb	96.60

Lighting Tools

Heavy Duty Krypton Light

Widely recognized as one of the highest quality car opening lights made. Virtually indestructible.

Case is high impact plastic; wand is made from heavy duty coaxial cable; switch has a 50,000 cycle testing. Lifetime Warranty (every part except the bulb). Powered by 3 C-cell batteries. Use Krypton replacement bulb.



684-0065	AL2000	Light	\$167.80
----------	--------	-------	-----------------

Replacement Bulbs:

684-0040	AL12100	Broad Spectrum Bulb	\$17.80
684-0045	AL12110	Krypton Bulb	29.20

The Brightest Car Opening Light 6V Super Probe Light

Awesome illumination from this halogen light will change your car opening forever. Wand with 6 volt bulb. (Powered by either the AL3007 or AL3008, order separately, below)

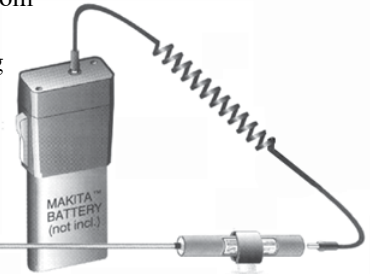

684-0070	AL3000	\$109.20
----------	--------	-----------------

Battery Holders for Makita batteries:

(battery not included)

684-0075	AL3007	7.2V	\$98.80
684-0080	AL3009	9.6V	98.80

Replacement Bulbs \$41.00 Each

684-0050	AL12120	6V for AL3000
684-0055	(U) AL12130	12V for AL4000

Lock & Safe Scope

This scope throws a strong beam of light, great for reading wafers and safe work. Made of impact resistant plastic. Comes with 3 tips, carrying case, and batteries.



Safe Tools
Magnifying Tools

684-0370	LT1202	\$79.80
----------	--------	----------------

Books & Manuals

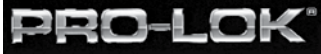

Over 15 years of research, PRO-LOK introduces the New Car Opening Volume: MABDVOL2006

Easy to Find Manufacturer. Each manufacturer is a different color tab. For example, the Acura section is red, Audi is blue... etc.

Easy Page Numbering Format. Each model is together, consecutively. This set up is so easy a table of contents is not necessary. For example: Mustang page 01 covers 1965-93 Mustang page 02 covers 1994-97 Mustang page 03 covers 1998-to current, if changed, page 04 will show the new opening method.

Easy to Update.

Alternate Methods. You don't have the right tool? Are you having trouble opening the car? At the bottom of each page there is an alternate opening method or tool if one is available.

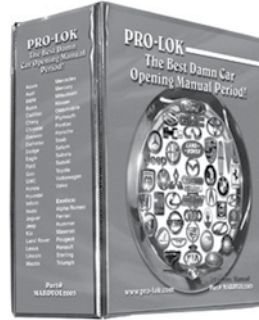

- 3 Ring Binder.
- Entire Book in Full Color.
- High Quality Gloss Paper.
 - Cross Reference Index.
 - Tool Index.
- Over 700 Pages.
- Over 450 Models.
- Over 40 Manufacturers.
- Over 400 Alternate Methods.
- Over 2200 Full Color Photos.
- Over 200 Full Color Illustrations.
- Covers 1980 - 2006

Order #1	Item #	Catalog Price
684-0012	MABDVOL2006	\$390.00



MABDUP2006 - 2006 Car Opening Manual Update

The 2006 Update covers the latest foreign and domestic vehicles on the road. The page size is 5 1/2" x 8 1/2". FULL COLOR photos of each and every vehicle. The PRO-LOK Car Opening

Update is the only manual that is completely printed in FULL COLOR! It is the best in the industry.

INCLUDES: Audi A3, Buick Lucerne, Cadillac DTS, Chevrolet Cobalt Coupe, Chevrolet HRR, Dodge Charger, Ford Fusion, Hummer H3, Honda Ridgeline, Hyundai Azera, Isuzu i280, Isuzu i350, Jeep Commander, Lexus IS 250, Lexus IS 350, Lincoln Zephyr, Mazda Mazda5, Mazda MX-5, Mercedes CLS-Class, Mercedes R-Class, Mercury Milan, Mitsubishi Raider, Pontiac Solstice, Subaru B9 Tribeca, Toyota Highlander Hybrid, and more!

Order #	Item #	Catalog Price
684-0013	MABDUP2006	\$78.00



2007 Car Opening Update MABDUP2007

2007 Update Facts & Features: The 2007 Update covers the latest foreign and domestic vehicles on the road. The page size is 5.5" x 8.5". FULL COLOR photos of each and every vehicle. The PRO-LOK® Car Opening Update is the only manual that is completely

printed in full color. It is the best in the industry.

Includes New Models:

- Chevrolet Silverado Classic
 - Dodge Caliber
 - Hyundai Entourage
 - Mazda CX-7
 - Isuzu i290
 - Isuzu i370
 - Saturn Aura
 - Lincoln MKX
 - Lincoln MKZ
 - Saturn Sky
 - Toyota Yaris
 - Toyota FJ Cruiser
 - Volkswagon Eos
 - Volkswagon Rabbit
- And More . . .

Order #	Item #	Catalog Price
684-0016	MABDUP2007	\$78.00

LOCKSMITH TOOLS

Books & Manuals

E-Z Picking Book

Packed with full color cut-away illustrations and detailed instructions. Understand the art and science involved in process of picking. Clearly written, easy to understand book on picking. 100 pgs.



684-0340	MAEZ2	\$75.60
----------	-------	---------

Pick Sets

PKX-11

Pick Set 11 Picks & Case

Set includes 3 picks with stainless steel handles, 3 standard picks, a double ended slim line pick, broken key extractor and 3 tension wrenches in soft luggage quality leather snap case.



684-0455	PKX-11	\$36.20
----------	--------	---------

PKX-14

Pick Set 14 Picks & Case

Popular pick set comes with 9 picks and a broken key extractor, all manufactured of tempered stainless steel and all with rivetless stainless steel handles, 4 tension wrenches in a soft luggage quality leather snap case.



684-0450	PKX-14	\$44.80
----------	--------	---------

PKX-20. Pick Set 20 Picks & Case

This set contains 14 assorted picks (6 with rivetless stainless steel handles), a broken key extractor and 5 tension wrenches in a soft luggage quality zipper leather case.

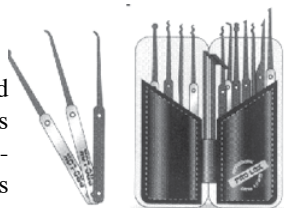

684-0460	PKX-20	\$75.00
----------	--------	---------

Pick Sets

PKX-32

Pick Set 32 Picks and Case

This large set includes a variety of tempered stainless steel hooks, rakes, balls, diamonds, key extractors, and tension wrenches in a soft luggage quality zippered leather case.

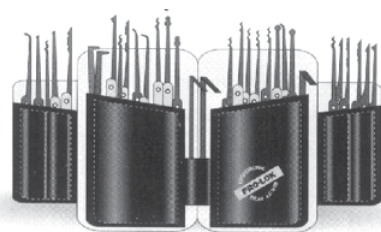

684-0465	PKX-32	\$108.00
----------	--------	----------

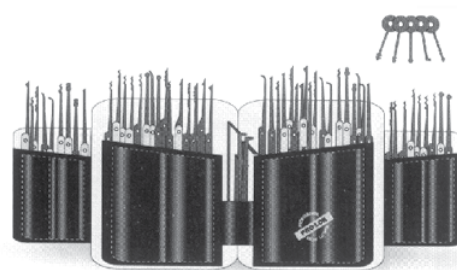

Open the quality zippered leather case and you'll find the finest lock picks made. The PKX-62 includes an array of hooks, diamonds, balls, rakes, and broken key extractors manufactured of tempered stainless steel and features rivetless stainless steel handles that provide maximum picking comfort, six tension wrenches, and a PKX-WP5 warded pick set.

684-0470	PRO PKX-62	\$241.60
----------	------------	----------



PADLOCK Shim Picks

A simple option to picking on many padlock styles. Many of the most commonly used less expensive laminated and solid body padlocks can be opened in seconds by circumventing the shackle locking points with these shims. The set contains 5 each of four different sizes.

684-0550	PRO PKPS	\$45.80
----------	----------	---------

Ace Tools Tubular Lock Picks

Ace Pick

A precision tool designed to allow you to easily open any standard Ace type lock. Simple to use.



684-0475 | PKA1 | \$141.40

Electric Pick Guns

The rechargeable Electric Pick Gun uses a consistent action to make picking many locks a very simple procedure. Comes with electric recharger.

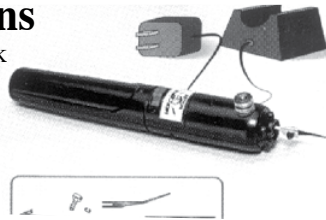

684-0480 | PKELPG | \$275.00

Manual Pick Guns

The best pick gun available. Allows you to pick a wide variety of locks. Comes with 3 tips and a tension wrench.



684-0485 | PKPG1 | \$121.40

Lifetime manufacturer's warranty

Ace Tools

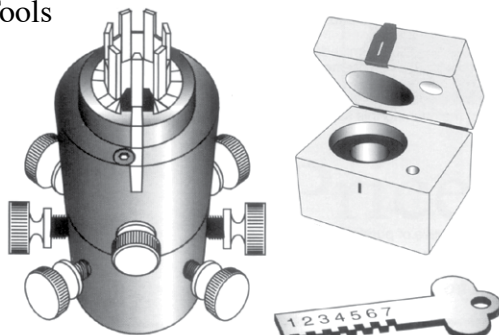

Deluxe Ace Pick

Locks can be picked by 2 methods (each pin individually or all at once). Picks left hand, right hand and center. Comes with its own decoder. Manufactured out of aluminum and 12L14 steel, with 1095 carbon spring steel picks. Glossy black anodized finish. Comes in a custom wooden storage box specially designed to protect your tool to last a lifetime. Similar to the old "Lee Pick".

Order #	Item #	Price
684-0490	PKA2	\$546.00

Impressioning Tools

Makes impressioning faster and easier. Maintains a true centerline and grips the key so it can't slip.

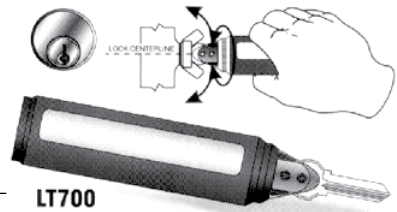

684-0425 | LT700 | \$77.00

Clip-Zip Tool

Makes door panel removal simple. Place the tool between the door clip and panel and squeeze the tool for easy clip removal. No more ripped panels or broken clips.



684-0385 | LT410 | \$73.60

Face Cap Pliers

Make the removal of face caps safe and trouble-free. Works quickly and effortlessly with no training or practice.

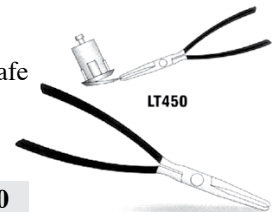

684-0410 | LT450 | \$67.00

Window Crank Tools

Makes removal of window cranks easy without damage to the door panel. Slip the tool behind the crank and push the retaining clip off the shaft.

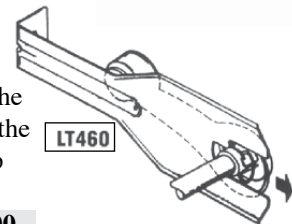

684-0415 | LT460 | \$16.00

Rhodes Nut Tools

Replaces the nut driver that Schlage provides with the Rhodes lock. Made from aluminum and its easy-to-grip design will allow you to quickly hand tighten the inside escutcheon nut.

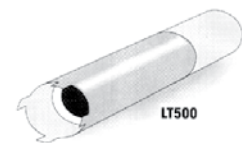

684-0420 | LT500 | \$54.60

No-Spill Key Hooks. \$47.80 per bag

Holds 25-30 blanks per hook. Improved design eliminates breaking & dropping. 100 hooks per bag.

Order #	Item #	Color
684-0280	KHBL	Blue
684-0285	KHBR	Brown
684-0281	KHTE	Teal

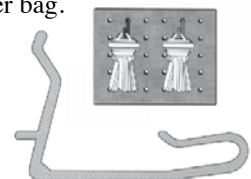

LOCKSMITH TOOLS

Pro-Lock

Deluxe

Zippered Case

Two sturdy loop handles, four individual storage compartments, unique Tool Positioners, a full length hefty zipper and heavy duty nylon cloth combine to store and protect your lockout tools*. The versatile design lets you arrange your tools in any layout. Double panel keeps wire or flat tools in position with our exclusive Velcro type Tool Positioners. Get this and get organized! *Tools not included.



684-0595	AO56	\$72.20
----------	------	---------

'97 Camry/ Lexus Tool

Car Opening Tools

Two tools
in one!



Redesigned '97 Toyota Camry offers a new challenge to lockout specialists. One end of tool overcomes protective panel in the front door to open it in seconds. Other end offers entry into rear door of '95, '96, and '97 Lexus LS 400 sedans.

684-0585	AO44	\$27.80
----------	------	---------



MP Removal Followers

Versatile follower can be used for rekeying most common commercial and residential lock cylinders. Also allows upper chamber master pin removal with a quick twist. Red anodized aluminum lets you find it easily in your toolbox.

684-0600	LT370	\$29.50
----------	-------	---------

4 Piece Follower Set

Made from high grade machined aluminum. Handsome red anodized color is easily found in your toolbox. Plug followers fit 90% of the Rim, Mortise, and Knob Cylinders on the market today. Contains:

LT371-395 (.395 dia.)	LT371-495 (.495 dia.)	
LT371-500 (.500 dia.)	LT371-555 (.550 dia.)	
684-0575	LT371	\$60.00

Cruiser- Kompressor Tool Double Ended Tool!

The short "L" end of the AD47 is designed to open the '91-'97 Toyota Land Cruiser and the '96-'97 Lexus LX450. The tip of the tool is used to activate a bell crank, unlocking the front door. The long "L" end is designed to manipulate the bell crank on the '97-'98 Mercedes SLK Kompressor.

684-0635	AO47	\$27.80
----------	------	---------

Drill Bits

Safe Tools

"Butter Bits" Safe Drilling Bits

Designed and manufactured in England with unique negative rake angle. Special design increases cutting ability while minimizing tip failure. Rapid penetration ability.

Order #	Item #	Size (dia. x length)	Price
684-0495	SB02	3/16" x 6"	15.60
684-0500	SB05	1/4" x 4"	16.40
684-0505	SB06	1/4" x 6"	17.60
684-0515	SB12	5/16" x 8"	23.60
684-0520	SB15	3/8" x 5"	25.40
684-0525	SB16	3/8" x 8"	28.40
684-0530	SB17	(U) 3/8" x 12"	39.00
684-0535	SB20	1/2" x 6"	33.60

Loop-D-Loop, Most BMW, Volvo, Mercedes.

Unique tool offers new approach to lockouts. Fed in under the window, the 'loop' is fixed around the smooth or mushroom style button head and pulled tight, then lifted up to unlock. Double ended, two reach-in-lengths.

684-0590	AO45	Loop-D-Loop	\$35.00
----------	------	-------------	---------

Key Decoders

Top quality stainless steel provides strength and durability for these individual key decoders.

The stamped depth increments will never wear off. Designed with Sure-Stop steps, each increment reflects factory specs and tolerances. Replaces worn out original decoders.



Order #	Item	For	Price
684-0605	KDIC	Best/Falcon IC A2	\$14.00
684-0610	KDSC	Schlage	14.00

RYTAN Pick Sets

**TYPE 2
SET 11**

Instruments.

RYT-RYP-13 Includes assortment of traditional size tools in popular styles with ergonomic handles, PLUS broken key extractors & adjustable tweezer tension wrenches. Durable case. (2-1/4 x 6-1/4")

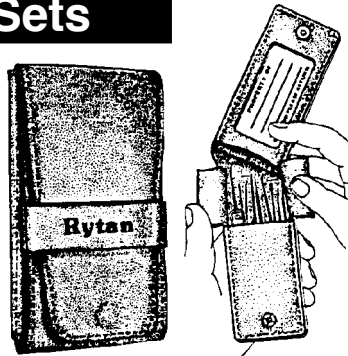

723-0090	RYP-13	\$54.60
----------	--------	---------

TYPE 4 SET 16 Instruments.

RYT-RYPK. Includes traditional size ball, hook, rake and diamond picks, PLUS new Tri-Ball, Bill DeForrest and Riffle designs. Assortment of tension wrenches and key extractors. Durable case. (3-1/4 x 6-1/2")

723-0095	RYPK	\$90.96
----------	------	---------

TYPE-3 SET "Mini-Blue".

RYT-MRPK-10. 10 Instruments. Picks with blades scaled down 20% compared to traditional picks, great for opening locks with small keyways, & for groovings that confine regular tools. Key extractors & tension wrenches included. Durable case.(2-1/4 x 6-1/4")

723-0055	MRPK-10	\$56.70
----------	---------	---------

RYTAN Individual Lock Picks

Traditional Picks (Ergonomic) Stainless Steel Pick Blades. **\$3.98 ea**



Miniature Picks (Ergonomic) Stainless Steel Pick Blades

	MBPX-5	Dbl. Ball	723-0030
	MBPX-10	Diamond	723-0035
	MBPX-11	Full Rake	723-0040
	MBPX-12	Hook	723-0045
	MBPX-14	B. DeForrest	723-0050
	RLPX-10	Std. Diamond	723-0060
	RLPX-11	Std. Full Rake	723-0065
	RLPX-12	Std. Hook	723-0070
	RLPX-14	Bill DeForrest	723-0075
	RLPX-15	Std. 3/4 Rake	723-0080
	RLPX-16	Std. 1/2 Rake	723-0085

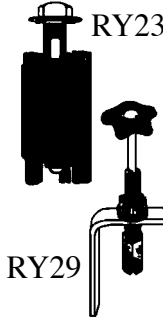

Roto Puller™

3 Tools in One

Is 3 steering Wheel Pullers in one. 3 different sets of built in puller bolts for three different thread sizes used on GM, Dodge, Ford and AMC cars. Standard threaded (Not Metric). Instructions included.

723-0023	RY-23	\$149.90
----------	-------	----------

Roto Pusher™ RY29

Only tool for telescoping steering columns made by GM. Access plate depressor works on GM standard, tilting & telescoping steering columns. Standard threading (Not Metric). Instructions included.

723-0029	RY-29	\$107.00
----------	-------	----------

Cylinder Removal Tools for Kwikset.

Pops out cylinders from 400 series knobs in a jiffy. Self-aligning design insures expanding tips come in direct contact with retainer clips every time.

723-0036	RYT-RY-36	\$51.50
----------	-----------	---------

DUAL FORD DRILL JIG

RY2525. Drill 1984-1/2 & newer side bar ignition locks, Plus Ford Taurus & Mercury Sable.

723-2525	(U) RY-2525	\$91.90
----------	-------------	---------

Rytan Plug Spinners RY-57

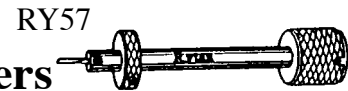

Unique Plug Spinner will turn plug rapidly past shear line without relocking. Won't overspin plug, as rotation is confined to 180° either left or right. Simply cock shaft knob, insert tip into keyway, & push button.

723-0057	RY-57	\$41.70
----------	-------	---------

5 Pack of Replacement blades:	723-0058	\$19.70
-------------------------------	----------	---------

RY 5798 Compact Plug Spinner

Same original Push Button technology in the famous RY 57 Plug Spinner. The RY5798 packs more WAL-LOP than the RY57, and it costs a lot less!

Order #	Item #	Price
723-5798	RY 5798	\$19.90

LOCKSMITH TOOLS



600T

PLATT Tool Cases

All Platt tool cases come with a practically indestructible pallet. Made of Texin, & exceptionally tough urethane elastomer material. Pockets are molded, without seams, stitches or rivets, forming a solid one piece unit.



TOOLS NOT INCLUDED.

PLT-600T. Our biggest seller. Has aluminum rim for extra strength, aluminum rivets, stainless steel hinges, heavy duty steel core handle, nickel plated brass key locks. Steel stays keep lid open with full load of tools. Measures 18.5 x 13 x 6", weighs 8.25 lbs. With two pallets. Black.

665-0600	PLT-600T	\$294.00
----------	----------	----------

PLT-605T. Same features as the 600T, but slightly smaller, measuring 18.5 x 13 x 4.25", weighs 6 lbs. Comes with one pallet. Black.

665-0605	PLT-605T	\$268.80
----------	----------	----------

SCHLAGE

Schlage Pin Kit 40-119. Keying Kits.

In Seal Tight Metal Box.

For pin tumbler locks. Contains: Bottom pins (0-9), master pins (2-9), Top pins, springs, cap retainer pins, retainer springs, cylinder caps, shim stock, tweezers, follower, bar, cap remover tool.



740-0126	40-119	\$411.84
----------	--------	----------

Schlage Key Gauges.

SCH-40-104

740-0125	40-104	\$17.28
----------	--------	---------

Decoders

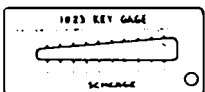

SCHLAGE

Competitive Keying Kits enable Schlage Residential "B" and "F" Series cylinders to be keyed into a competitor's key system.

**Kwikset Key Conversion
Kit # 40-090**

**Weiser Key Conversion
Kit # 40-094**



Many homes have 3 or 4 working Grade 3 Kwikset or Weiser entry locks on the house. Now you can offer the quality of Schlage "Just One Key" convenience and stay within a modest budget.

With the Conversion Kits, you can put a Schlage F entry lock or B deadbolt on a KW1 or WE1 system.

Kits contains Cylinder Plugs and Pins necessary for the conversion, as well as tweezers, follower bar, cap removal tool, key gage, retainer rings, retainer cap pins & springs.

Order #	Item #	Kit For	Catalog Price
740-4090	(U) 40-090	Kwikset	\$531.00

SCHLAGE

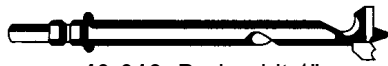

Drill Bits

40-019 Boring bit 1"

40-025 Boring bit 2 1/8"

40-028 Boring bit 1 1/2"

Boring Bits:



740-0118	1"	40-175	\$101.24
740-0119	2-1/8"	40-176	254.88
740-0121	1-1/2"	40-177	221.76

WEISER

WEISER Keying Kits

WEI-1418. Complete assortment of cylinder pins, springs, tailpieces, retaining rings, and instructions. Also: plug follower, cylinder cap removal tool, retaining ring pliers, tweezers, shim pick and key gauge.

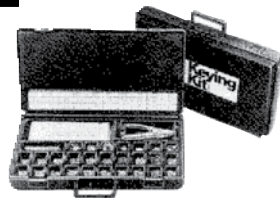

940-0008	WEI-1418	\$144.36
----------	----------	----------

Weiser Keying Kit



Weiser 1411 Keying Kit w/Master Wafers
Replaces 1387.

Order #	Item #	Catalog Price
940-0004	1400	\$270.84

Marking Tool Sets

WEI-1599

Precision, labor saving tool sets designed to locate and mark the latch face and strike outlines on wood doors and frames. A strike locating tool which locates the strike in perfect relationship to the latch is included in each set.

Strike Markers

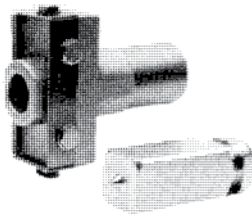

Contains: One marking tool, #A8924 (2-1/4 x 1").
One strike locator, #A8599-2.

940-0018	WEI-1599	\$95.16
----------	----------	---------

WEISER LOCK™

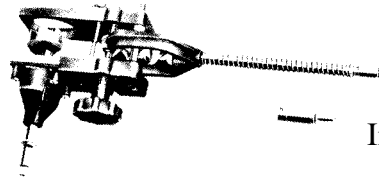

Installation Tools

Guided Drill Boring Jig

Pressure cast aluminum, rib-reinforced, tempered steel guide plates, instructions. With built-in bits. Drill adapter and bits included. 2-1/8" diameter side hole, 1" diameter latch hole, 2-3/8, 2-3/4 and 5" backset.

940-0057	WEI-1963	\$624.72
----------	----------	----------

Bit Guide Plate.

2-1/8" replacement guide for boring jig.

940-0192	WEI-9925	\$4.68
----------	----------	--------

Drill Bits

1483



Weiser Multi Spur Bits.

For Power Drill Use.

940-0016	WEI-1483	1"	\$149.28
940-0015	WEI-1482	2-1/8"	149.28



WEISER Shim Picks.

940-0011	WEI-1425	\$2.04
----------	----------	--------

3-WAY Cylinder Cap Removal Tool.

940-0191	WEI-1029	\$7.08
----------	----------	--------

Key Gauges

Decoders

for New Style Weiser Locksets

940-0003	12613	\$8.76
----------	-------	--------