



KEY CABINETS SECTION 7

KEY CABINETS

Key Cabinets

D

Digital KeySafe	11
-----------------	----

E

Emergency Key Box	3
-------------------	---

K

Key Box	3
Key Keeper	1, 3, 5, 6, 8, 9, 10, 11, 12, 13
Key Traps	8

M

Medi-Kab	5
----------	---

S

SlimKabs	4
----------	---

T

Tags	2, 5, 7, 14
------	-------------

V

Vendors	
BOMMER	1
HPC	2, 3, 4, 5, 6
MAJOR	8
MASTER	6, 7
OLYMPUS	13
SUPRA	9, 10, 11, 12
TELKEE	14

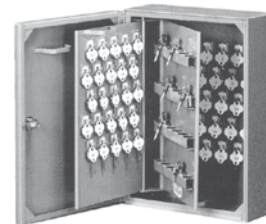

BOMMER

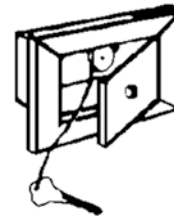

BOMMER Key Keeper

#5620-628
Aluminum construction.
Permits use of automatic locking street entrance doors for apartments, maintaining security but allowing mailman to enter building.

U.S. Postal prep - Lock supplied by the US Post Office.

Frame: 4-3/4" high x 6-3/8" wide.

Door: 2-3/4" high x 4-3/8" wide.

Wall cutout: 3" high x 4-3/4" wide x 1-3/4" deep.

Order #	Item #	Cat. Price
145-0300	5620-628	\$69.30

HPC Two-Tag KeKabs

Designed to control and provide security, enabling you to loan a key, while keeping a copy in the cabinet. Designed to be mounted on a wall, near a desk or work station.

Each HPC KeKab® II security control system includes:

- Red Plastic Octagonal Permanent Key Tags with a self-locking key holder. This key tag is designed to hold the original key and remain in the KeKab®. The tags are numbered for easy identification.
- White Plastic Cloverleaf Loaner Key Tags that are used to hold duplicates of the permanent key. The tags are numbered for easy identification.
- Key Organization Sleeves that are for the collection of keys. These sleeves are pre-printed with room for pertinent information.
- Key Receipt Slips that are designed to keep a record of keys loaned out. Personnel must fill out slips in order to obtain a key. The slip is then hung on the appropriate hook in the KeKab® in place of the loaned key.
- Brass Receipt Holder for optional use of holding key receipt slip on hook. (Complies with governmental regulations.)
- Cross Reference Binder that contains three referencing methods for a detailed record of all keys. Includes complete key loan record, cross reference sheets and detailed instruction sheet.
- It comes with a 3/8 inch key retaining 5 wafer cam lock or a high security 7 pin tubular lock with popout T-Handle.
- Unique powder coat textured painting process that provides an attractive and very durable finish on all KeKab® units. The neutral sand color allows them to be hung anywhere.
- Heavy Gauge Steel Construction with piano hinged doors & key panels provide a sturdy location to secure your keys.

Order #	Item #	Dimensions	Wt.	Cat. Price
360-0601	T30	12" x 8" x 2.5"	8 lbs	\$199.90
360-0602	T40X	17" x 13" x 3.25"	12 lbs	198.00
360-0603	T60	17" x 13" x 3.25"	16 lbs	272.00
360-0604	T80X	20" x 16.5" x 5"	19 lbs	298.00
360-0605	T160X	20" x 16.5" x 5"	27 lbs	444.00
360-0606	T240	20" x 16.5" x 5"	34 lbs	588.00

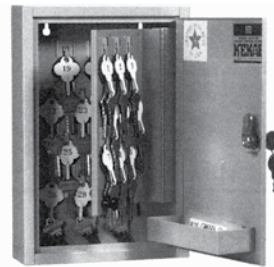

KEKAB-T30

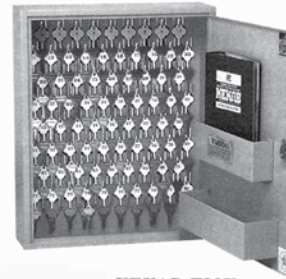

KEKAB-T80X

X at the end of a KeKab stock number denotes that the cabinet is expandable.



T500 shown (available by special order), T200 and T120X are similar

Two-Tag KeKab Series

The hooks in these cabinets hold two tags. The red tag is for the "permanent" key and is designed to remain in the cabinet (except for when used in an emergency or to make a new duplicate). The white tag is for the "loaner" key and is used when issuing keys.

Dimensions: 20" x 16.5" x 5"
5-wafer Cam Lock.

Order #	Item #	# Keys	Catalog Price
360-0608	KeKab-T200	200	\$566.00
360-0607	KeKab-T120X expands to 200 keys	120	386.00

Available by special order: HPC Dual Key Tags

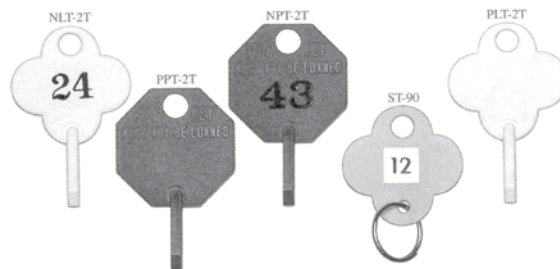

HPC KEKABS

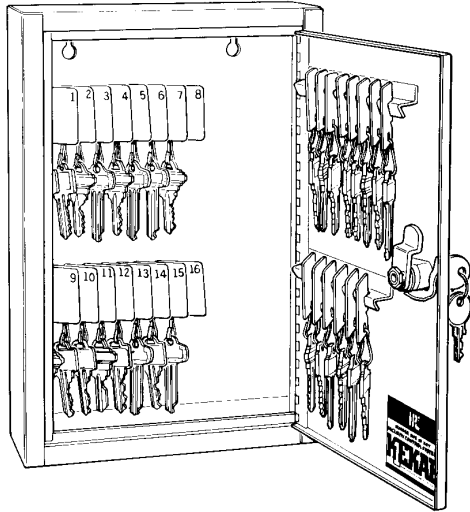

NOTE:
260X, 500
& 730 have
a heavy
duty locking
"T" handle,
incorporating a high
security 7
pin tumbler,
tubular type
lock.

HPC KEKABS

Offer a handy, central location for keys, under security conditions. KEKAB doors & panels have piano type hinges, and are locked by a five disc tumbler cam lock.

Order #	Item/ Capacity	Price
360-0201	KEKAB-30	\$67.00
360-0214	KEKAB-40	79.00
360-0202	KEKAB-60	110.00
360-0216	KEKAB-80	127.90
360-0203	KEKAB-120	159.90
360-0204	KEKAB-160X	202.00
360-0205	KEKAB-240	270.00
360-0206	KEKAB-260X	376.00
360-0207	KEKAB-330	338.00
360-0208	KEKAB-500	542.00
360-0209	KEKAB-730	740.00

Expansion Leafs for 160X

Leaf expands KEKAB-160X from 160 capacity to 330.

Order #	Item	PRICE
360-0196	KEKAB-A	\$179.90

Kebox-8 Cabinet

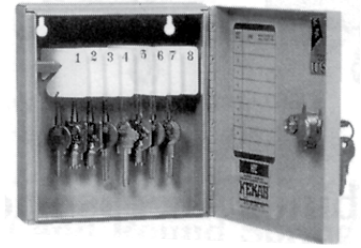

Compact, eight capacity cabinet provides convenient, locked central location for key storage. Same high quality standards as the general KEKAB line.

Order #	Item #	PRICE
360-0210	KEBOX-8	\$51.90

Carry On KEKAB

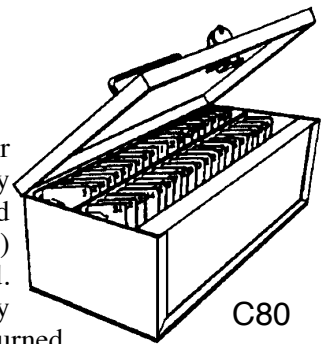

Versatile; used in desks or file cabinets. Or quickly assemble lockable hinged top (equipped with handle) & "carry on" to job at hand. Keys hold uniformly to key racks even when unit is turned upside down. With single-tag Kekab components & 5 wafer tumbler cam lock with 2 keys.

KEKAB-C40. 40 Key capacity, 5-1/2" x 12" x 6"

360-0198	KEKAB-C40	\$154.50
----------	-----------	-----------------

KEKAB C80. 80 Key capacity, 5-1/2" x 12" x 12".

360-0199	KEKAB-C80	\$199.00
----------	-----------	-----------------

Emergency Key Box

Designed to house a restricted door key at the immediate location. Bright red steel box has key locking hinged door with a glass window. When an emergency arises, break the glass with the attached hammer.



Order #	Item #	PRICE
360-0517	HPC-511	\$56.70
360-0985	Glass Only (plexiglas)	12.40



HPC's SlimKab™ Line available in two larger expandable sizes!



SK25 shown

SlimKabs, an economical line of key control cabinets. Made of 22 gauge steel and are painted in a neutral sand color. The hooks for the tags are a single prong style (made for standard rings). The clover leaf fiber tags come with pressure sensitive numbered labels for the user to apply. The tags can also be easily written on.

Standard Models:

Order #	Item #	Keys	Cat.Price
360-2358	SK-75	75	\$123.50
360-2359	SK-90	90	131.90

Expandable Models:

360-2356	SK-45X	45	\$92.00
360-2357	SK-55X	55	107.00

Expansion Leaf:

Available by special order (adds 35 more keys)

HPC

SlimKab Line

HPC's new SlimKab line is an economical line of key control cabinets. They are available in two expandable sizes; 15 key capacity (expandable to 25)

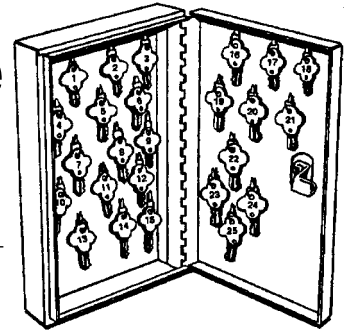

and 20 key capacity (expandable to 35). Made of 22 gauge steel and painted in a neutral sand color. Hooks for tags are a single prong style (made for standard rings). The clover leaf fiber tags come with pressure sensitive numbered labels for the user to apply. The tags can also be written on easily.

Dimensions: 6" wide x 10.5" high x 1.5" deep.

Order #	Item #	Capacity	Price
360-2331	SK-15X	15	\$56.00
360-2332	SK-25	25	70.00
360-2333	SLK-10	10, expansion leaf	40.50

Dimensions: 8" wide x 10.5" high x 1.5" deep.

360-2336	SK-20X	20	\$57.50
360-2337	SK-35	35	74.50
360-2338	SLK-15	15, expansion leaf	45.00

HPC KEKAB-V50 VERTICAL KEY CABINET

Designed especially to be mounted in hard to fit places. Both are made with heavy gauge steel and finished with a two-step textured epoxy paint.

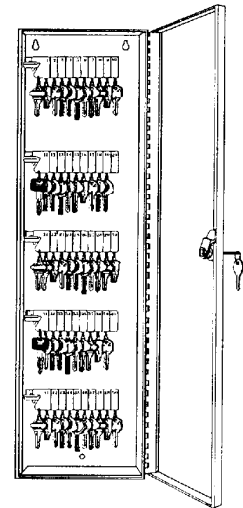

Height: 29-5/8". 7" Wide and 1-1/2" Deep.

Capacity: 50

Order #	Item #	Cat. Price
360-2335	HPC-KEKAB-V50	\$114.00

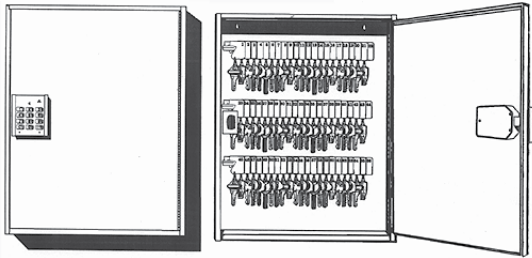

HPC Digital KeKabs

All the same features of the regular KeKabs, but are opened by a user friendly keypad, rather than a key.

Two levels of access (User and Manager), with an overriding Owner code, instant re-programming, usage indicator, and automatic lock-out. Battery operated and require no wiring or central processors. Typically operates 3 or 4 years on 2 alkaline batteries, depending on usage. Power indicator warns when batteries are low, and special jumper ports allow access of external power in the event of battery failure. All metal construction and built to last.

Order #	Item #	Keys Held	Price
360-2370	KEKAB-DL65	65	\$398.00
360-2371	KEKAB-DL95X	95	518.00
360-2372	KEKAB-DL265	265	590.00

Expansion leaf converts DL95X into a KeKab-DL265:

360-2373	KEKAB-DA		\$164.00
----------	----------	--	-----------------

HPC Medi-Kab

Offers the most secure location for medicine and pharmaceuticals. Welded construction is from the finest heavy gauge steel. Features a rugged piano hinged door. All Medi-Kabs use a 5-pin wafer lock.

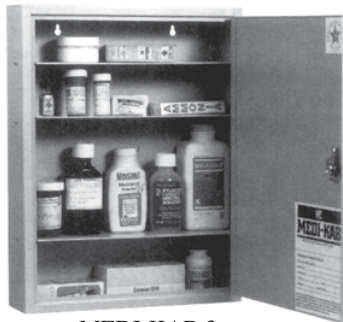

MEDI-KAB 3

Powder coat textured painting process provides a neutral sand color finish.

Medi-Kab 3: 4 lbs.
Medi-Kab 6: 10 lbs.

Order #	Item #	Size	PRICE
360-0212	Medi-Kab-6	17 x 13 x 3-1/4"	\$141.70
360-0211	Medi-Kab-3	12 x 8 x 2-1/2"	97.70

HPC

HPC Out Tags, 100/box

360-0263	OT-100	\$21.90/box
----------	--------	--------------------

HPC Plain tags, 100/box

360-0297	PLT-1	\$40.50/box
----------	-------	--------------------

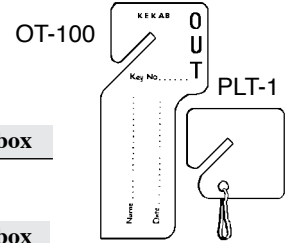

HPC

Key Keepers

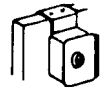
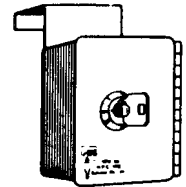

Real Estate

Key Keeper

Box is placed over the top edge of a door. When door is closed, the top mounting screws are hidden. Piano hinged box door.

3-1/4 x 2-1/2 x 2". No dust cover. 7-Pin tumbler key lock.

Order #	K.A. #	PRICE
360-1010	KEP-12 KA-3395	\$49.90
360-1015	KEP-12-KA 3396	49.90
360-1020	KEP-12 KA-3397	49.90

Auto Key Keeper

Place car's keys into box. Lower the door window and slip the Key Keeper's back clip over the top edge of the glass. Roll window up to secure box. High security 7 pin tumbler tubular lock with dust cover. Size: 2-1/2 x 2-1/4 x 1-1/2". 18 gauge steel. Grey hammer tone enamel. **Price: \$58.70**

360-1035	KEP-14	KA-3395
----------	--------	---------

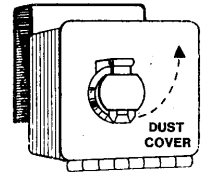

Truck Key Keeper

Mount under hood on inside fender or body wall, with the three included sheet metal screws. Dust cover on lock. Size: 2-1/2 x 2-1/4 x 1-1/2". Made of 18 gauge steel. Prime baked grey hammer tone enamel. Tubular Key Lock: **Price: \$53.50**

360-1065	KEP-16-96	KA-3396
----------	-----------	---------

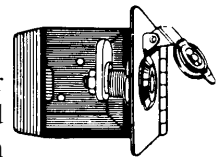



**Peg Board
KeKab**

Ideal for the shop or van, this cabinet secures a 12" x 12" peg board full of key blanks ready to be cut. Protect high security blanks and eliminate blanks from falling in your van.



KEKAB-PEG

Order #	Item #	Catalog Price
360-0226	HPC KEKAB-PEG	\$280.00

Keyable KeKabs

This new line of Security Cabinets allows you to add your own mortise cylinder and key them into your existing master key systems. Available in three sizes.



Order #	Item #	Capacity	Catalog Price
360-0223	KEKAB-KK65	65	\$308.00
360-0224	KEKAB-KK95X	95	354.00
360-0222	KEKAB-KK265	265	470.00

MASTER

Select Access Master Lock

Key Storage . . . Key Keeper

No Lockouts - No Schedule Conflicts

No need to hide keys under the mat or in the flower pot. Lock your property and provide access to the select few with Master lock Select Access.

Select Access key Storage Locks offer:

- Large key storage compartment - holds over 5 door or car keys
- 4-dial resettable combination lock - provides simple, set-your-own combination convenience
- Zinc lock body and shutter door - weather resistant for years of dependable operation
- Attractive design - blends with decor to minimize attention.

Wall Mount Key Storage Lock. 5401D

Real estate sales, Repair service personnel, House and pet sitter. Hardware included - easy attachment to any wall

Order #	Item #	Catalog Price
555-0102	5401D	\$44.04

Portable Key Storage Lock. 5400D

Children after school, Cleaning service employees, Elder care provider. Molded bumper and vinyl coated shackle - prevents scratches to your door. Hardened steel shackle - resists cutting.

Order #	Item #	Catalog Price
555-0105	5400D	\$46.96

MASTER



5401D



5401D



5400D



5400D

Master Lock

Heavy Duty Key Cabinets



7122

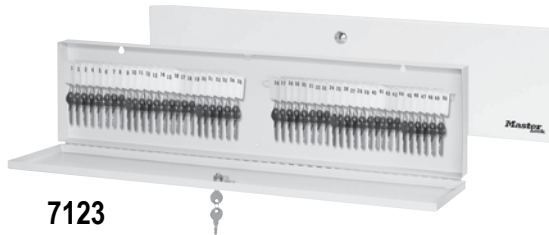

7123



7124

- Retail Carded Products
- Heavy duty steel construction with full length, hinged door and built-in, slotted key racks
- Durable, beige powder coated cabinet finish
- Rekeyable W1 wafer cylinder with improved pick resistance
- Key retaining security insures key cannot be removed until cabinet is locked
- 2 keys, key holders, cross reference chart and installation hardware included
- No. 7117 snap hook design fits slotted and key style key cabinets, boards, etc.



7125

Heavy Duty Key Safe:

Order #	Item #	# Keys	Dimensions	Cat. Price
555-7122	7122D	30	12"x8"x2.5"	\$64.28
555-7123	7123D	48	7.5"x28.75"x1.75"	107.06
555-7124	7124D	50	28.75"x7.5"x1.75"	107.06
555-7125	7125D	60	12.25"x10.75"x3"	107.84
555-7126	7126D	120	17"x13"x3.25"	174.20



7126



7117 Tags Only

Plastic Key Hanger/Holder

555-7117	7117D	20 per bag	\$8.16
----------	-------	------------	---------------



KEY TRAPS:

The Key Trap is a simple way to help solve key control problems. A master or operating key can be locked in the key trap. A check out key with a serial number that will identify the user releases the master key. Releasing the master key with a turn of the check out key will lock the check out key in the trap until the master key is returned. Returning the master key will unlock the check out key and secure the master key.

The Key Trap is available in one, two, three and four block gangs. The block is locked to the mounting base with an "Ace Type" cylinder.

The Key Trap will accommodate 1-1/8" or longer mortise cylinders, and is machined from a solid block of aluminum and anodized in a gray finish.

- 1 GANG:** A single key trap for use with standard type mortise cylinders.
- 2 GANGS:** Two single key traps mounted on a common base. Both key traps work independently of each other.
- 3 GANGS:** Three single key traps mounted on a common base. All three work independently of each other.
- 4 GANGS:** Four single key traps mounted on a common base. All four work independently of each other.



KT-110

KEY TRAP - STANDARD

Includes gear drive that replaces the mortise cylinder cam. The single key trap measures 3" x 4" x 2-5/16" high.

Order #	Item #	# Gangs	Cat. Price
527-1100	KT-110	1	\$261.50
527-1300	KT-130	3	783.50
527-1400	KT-140	4	1145.00



KEY TRAP - MEDECO

KT-240

Order #	Item #	# Gangs	Cat. Price
527-2100	KT-210	1	\$295.00
527-2200	KT-220	2	547.00
527-2300	KT-230	3	820.50
527-2400	KT-240	4	1093.50

KEY TRAP - BEST TYPE

Order #	Item #	# Gangs	Cat. Price
527-3100	KT-310	1	\$333.50
527-3200	KT-320	2	667.50
527-3300	KT-330	3	1001.50
527-3400	KT-340	4	1335.50



KT-310

KEY TRAP - SCHLAGE PRIMUS & EVEREST - NOT FOR USE With Interchangeable Core Cylinders

A key trap for use with Schlage Primus and Everest high security mortise cylinders.



KT-420

Order #	Item #	# Gangs	Cat. Price	Includes
527-4100	KT-410	1	\$333.50	special link that replaces the mortise cylinder cam.
527-4200	KT-420	2	667.50	
527-4300	KT-430	3	1001.50	
527-4400	KT-440	4	1335.50	

KEY TRAP - SCHLAGE - LARGE FORMAT INTERCHANGEABLE CORE

A key trap for use with Schlage large format interchangeable core mortise cylinders. Includes special link that replaces the mortise cylinder cam.



KT-510

Order #	Item #	# Gangs	Cat. Price
527-5100	KT-510	1	\$333.50
527-5200	KT-520	2	667.50
527-5300	KT-530	3	101.50
527-5400	KT-540	4	1335.50

KEY TRAP - ASSA TWIN CYLINDER

A single key trap for use with ASSA twin cylinders. Includes gear drive that replaces the mortise cylinder cam. The single key trap measures 3" x 4" x 2-5/16".



KT-610

Order #	Item #	# Gangs	Cat. Price
527-6100	KT-610	1	\$262.50
527-6200	KT-620	2	532.50
527-6300	KT-630	3	783.50
527-6400	KT-640	4	1145.00

SUPRA®

StorAKey™

Key Keeper



**S6 Supra Pushbutton
Surface Mount**

Combination Key Box

- All metal construction, powder coat finish
- Stores two keys, any size
- Clamshell Package
- Perfect for lock-out calls & school children

Order #	Item #	Color	Price
860-0065	001370 S6	White	\$53.28
860-0070	001371 S6	Clay	53.28

S-6 Protective Cover

Clear Box

860-0050	001375 S6	Black	\$15.58
----------	-----------	-------	----------------



StorAKey™

Key Cabinet

Quick Access
Cabinets

Key hooks, QuickAccess Lock, Clay in color. 18 ga. steel

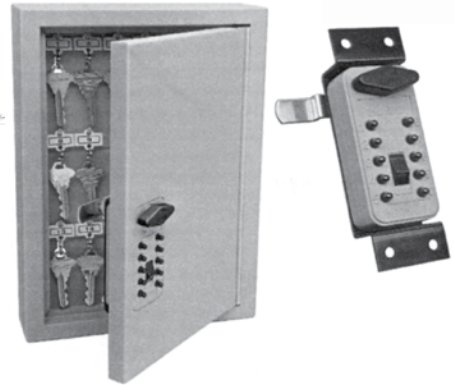

Order #	Item #	Capacity	Catalog Price
860-0080	001795	30 keys	\$108.00
860-0090	001796	60 keys	156.00
860-0100	001797	120 keys	228.00

GE Supra Quick Access Retrofit Lock

QuickAccess Lock only, reshipper box

Order #	Item #	Color	Catalog Price
860-0130	001798	Clay	\$58.50
860-0140	001773	Titanium	54.00

Stor-A-Key

Key case with powerful magnet that attaches to almost any clean surface. Stor-A-Key can be used for emergency access to vehicles or in your home. Weather resistant plastic will not rust. Foam insert and strap keeps key in place.



Choose each or 12 Piece "Clip Strip"

Order #	Item #	Catalog Price
860-0150	001843 ea	\$4.16
860-0155	001855 dz	49.80/12

Portable Stor-A-Key

Portable key case with resettable combination lock and adjustable cable. The adjustable cable hooks almost anywhere - hose bib, chain link fence, pipes, backpack/bag, shed, car/bike rack and more. Foam insert can be removed to hold keys, cash and more. Colors: Blue, Green, and Yellow

Choose each or 6 Piece "Clip Strip"

Order #	Item #	Catalog Price
860-0170	001948 ea	\$15.60
860-0175	001945 1/2 dz	93.54/6





Locking Stor-A-Key

Locking key case with resettable combination and powerful magnet. Spare key storage for auto, home, boat, office files, etc. Attach Locking Stor-A-Key anywhere using magnet or double sided taped metal plate. Easy key retrieval and foam insert to keep key from falling out. Equipped with anchor point for strap or cable tie.



Choose each or 6 Piece "Clip Strip"

Order #	Item #	Catalog Price
860-0160	001844 ea	\$10.40
860-0165	001856 1/2 dz	62.34/6

Key Safes

M5 Mortise KeyBox

Expand existing master key systems without changing keys or locks. Accepts 1-1/4" and 1-1/8" length mortise cylinders. Has four holes for mounting to a variety of surfaces. Four wood screws & a locknut included.

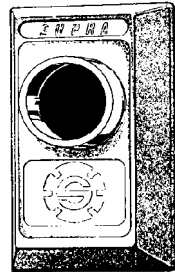

Order #	Item	PRICE
860-0005	M5 000534	\$50.68

Permanent Auto Mount

Pushbutton Combination Key Box

- Mounts permanently to vehicle, no magnets
- Pushbutton combination protects contents if found
- Keys are always where you left them
- Zinc alloy material with rubber protective cover

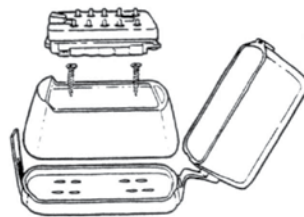

Order #	Item #	Package	Color	Price
860-0045	001312	Clamshell	Titanium Black	\$74.08



StorAKey

C3 All-Purpose KeyBox

Padlock style combination KeyBox can be mounted almost anywhere and can be easily moved. 3 letter combination lock can be easily set to 17,000 different combinations. Rubber bumper protects surfaces.

SUPRA



Instructions for setting new combinations are included. In handsome retail package.

Order #	Item	PRICE
860-0015	C3 000394	\$51.98

S5 Dial KeyBox

Surface mounted three letter combination KeyBox comes with 4 screws for mounting on a variety of surfaces. Can be easily set to 17,000 different combinations. Spare keys attach easily to lid of the KeyBox so they are never misplaced.



Instructions for mounting and setting different combinations are included. Supplied in a handsome retail package.



Order #	Item	PRICE
860-0010	S5 000404	\$50.68

S5 Supra Pushbutton Surface Mounted Combination Key Box

User resettable combination
Brass vault and lid
Over 17,000 combinations



Order #	Item #	Package	Color	Price
860-0060	001360 S5	Clamshell	White	\$53.28



AccessPoint is a new consumer product line from GE Security. It is comprised of key management solutions that allow convenient access and storage inside and outside your home.

Digital KeySafe

Designer key box with electronic time stamp records last nine access events. Easy-to-use, on-hand operation ensures quick access. Low profile, subtle design compliments door frame with a variety of neutral colors. Change code anytime for added security. Solid, weather resistant metal construction. Know what time your children or others enter your home.



Order #	Item #	Color	Catalog Price
860-0180	001882	White	\$71.98
860-0185	001884	Beige	71.98
860-0190	001886	Gray	71.98

KeySafe

Designer key box with easy one-hand operation for quick access. Available in assorted neutral colors, compliments the trim of your home, and mounts easily. Resettable combination can be changed as often as desired. Leave keys for:

- Children, relatives, friends, and neighbors
- Emergency access
- Housekeepers, contractors, and service professionals
- Rental properties



Order #	Item #	Color	Catalog Price
860-0195	001881	White	\$47.98
860-0200	001883	Beige	47.98
860-0205	001885	Gray	47.98

Key Keeper



Key Strip

Keep keys in one central location with this innovative key strip. Key is inserted into one of 10 slots, and can hold an entire ring of keys. Mounts to wall securely with screws and anchors (included)

Order #	Item #	Color	Catalog Price
860-0210	001896	Black	\$10.78

Key Organizer

Designer key organizer that mounts easily. Organize everyday items such as key rings, cell phones, and wallets in out cups. Concealed inner cabinet stores backup keys with identification labels.



Order #	Item #	Color	Catalog Price
860-0215	001897	Black	\$34.78

Key Cabinet

Key cabinet stores all of your keys in one place. Includes peg hooks for removable key tags with labels for easy identification. Modern design mounts easily with sprint-loaded door.



Order #	Item #	Color	Catalog Price
860-0220	001898	Silver	\$47.98

Locking Key Cabinet

Electronic locking key cabinet with resettable combination and lockout feature. Audio signals indicate if code was entered correctly. Hidden chamber for longterm storage of keys. Adjustable peg hooks for large size key rings. Low battery indicator (batteries not included). Ideal for small offices or wherever key control is a problem.

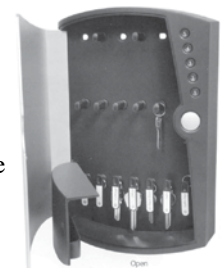

Order #	Item #	Color	Catalog Price
860-0225	001899	Silver	\$65.98



SUPRA®

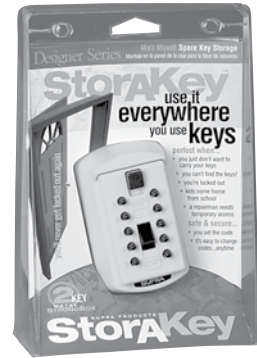
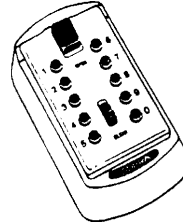

**C3 Pushbutton
Combination KeyBox**

Key Keeper

- User changeable pushbutton combo
- All purpose portable KeyBox
- Black DoorGuard rubber bumper protects surfaces

Order #	Item #	Price
860-0020	001192 C3	\$53.28

**S6 Pushbutton
Combination KeyBox**

- User changeable pushbutton combo
- Surface mount unit

Order #	Item #	Price
860-0025	001193 S6	\$53.28

"Big Box"

Supra's Big Box is a great addition to the STOR-A-KEY line of key storage items.

Capitalizing on the popularity of the pushbutton lid, the Big Box is easy to use and offers these valuable features for both residential and commercial applications:

- Access cards easily fit into larger storage area
- Accommodates more keys and bigger keys
- Tamper-resistant, durable design
- Combination can be quickly and easily changed with an ordinary screwdriver.



Inside Dimensions:

3⁵/₈" H x 2³/₈" W x 1³/₄" D

Great for shops and out-buildings or trailers and RV's!

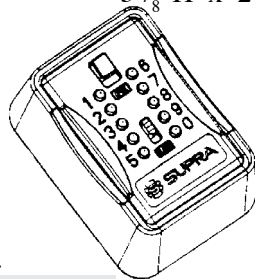

All metal, chrome plated lid. Large black painted vault. Big enough to hold access card and multiple keys.

Order #	Item #	Price
860-0030	001267 S-7	\$87.08

**Supra
J5 Pushbutton
Combination Key Box**

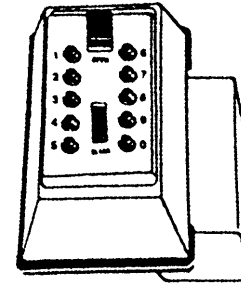

- Portable door mount
- Plastic back protects door
- User changeable pushbutton combo; Bulk packed

Price: \$51.98

Order #	Item #
860-0040	001161 J5

**Supra "StoreAKey"
Protective Cover for the S7 BIG BOX**

Order #	Item #	Catalog Price
860-0120	001509	\$17.98



ShurLok SECURITY LOCK BOX

Store Your Key! Key Keeper

Shurlok has designed an all-metal key storage box that is the safest, most secure lock box on the market.

Applications

- Access to commercial and construction sites
- After school access for children
- Emergency access for elderly households
- Access for maintenance people
- Access to vacation properties
- Use on recreational vehicles, boats, bicycles
- Easy access for family and friends
- Perfect for when you don't want to carry keys
- Never be locked out again.

Features

- 10,000 possible combinations
- Easily reset your own combination in seconds
- Durable all-metal construction
- Can be mounted anywhere with bracket accessory
- One combination opens shackle, another combination opens the key compartment
- 1 year warranty.

Order #	Item #	Price
638-0010	SL-100	\$39.54

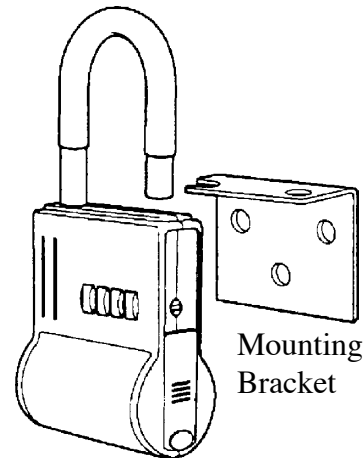

ShurLok

Mounting Bracket

If you don't see what you need, give us a call. We can special order just about anything!

Accessories: MOUNTING BRACKET

The SL-150 accessory bracket can be mounted to almost any surface, adding flexibility to where the ShurLok can be placed.

Order #	Item #	Price
638-0015	SL-150	\$3.96



Telkee Management Systems are simple, efficient and systematic methods for filing your keys. They give you complete control, along with security and convenience.

The keys in this line are numerically coded, so they are identifiable and accessible only to authorized personnel. The risk of theft is decreased to an absolute minimum.

Whether you use 20 or 2,240 keys, Telkee has the system that's right for you. The 18 gauge steel cabinets are available in a gray enamel finish.

Diplomat Table Top

The functional design of the dual-purpose Diplomat makes it a high capacity unit of unusual flexibility. With five to twelve "Swing-automatic" key panels, and "Vistascope" doors, the doors open to cabinet's full depth. Visibility and accessibility. Piano hinged doors equipped with chrome plated locking door handles and two keys. All Telkey "Complete System" components furnished.

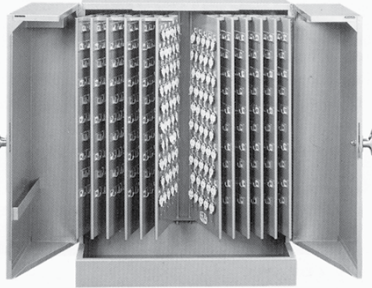

Catalog No.	Keys	Dimensions	Wt.
DWT-500-S	500	30" H x 24" W 10-1/2" D	100
DWT-600-S	600		107
DWT-700-S	700		113
DWT-800-S	800		120
DWT-900-S	900		127
DWT-1000-S	1000		135
DWT-1100-S	1100		142
DWT-1200-S	1200		150

ACCESSORIES

Key Markers - Octagonal - Permanent

To identify reserve - pattern keys from which duplicates can be made. These are stamped: "File Key Must Not Be Loaned." Available in plain & numbered tags.

Catalog No.	Item No.	Item
2RF	T6640	RED FIBER - Plain Tags
2RF-N	T6650	RED FIBER - Numbered
2GF	T6600	WHITE FIBER - Plain
2GF-N	T6610	WHITE FIBER - Numbered
2GR	T6620	GRAY FIBER - Plain
2GR-N	T6630	GRAY FIBER - Numbered

Also Available:

- Key Markers - Shamrock - Temporary
- Key Gathering Envelopes
- Hook Labels
- Key Rings (for Teachers Key Ring Cabinet)
- Cross Index Binder
- Cross Index Sheets & Cards
- Signature Receipt Forms
- Instruction Booklet

Telcore

For Controlling Keys and Inter- changeable lock Cores

Simplifies storage of removable and interchangeable lock cores. Telcore utilizes the Regent or Aristocrat cabinets and integrates core storage panels and key panels to make this a versatile unit. Panels holding 24 to 48 removable cores can be installed in any Regent, and an 84 unit panel can be installed in any Aristocrat cabinet. Core storage slots are identified by the number on the key itself. Telkee components furnished.

Three way to order the Telcore System

1. **Telcore panels only.** Add to an existing Regent or Aristocrat key cabinet.
2. **Telcore with Regent cabinet.**
3. **Telcore with Aristocrat cabinet.**

We can custom order to your specifications, from 24 to 168 Removable Core Capacity, and 25 to 250 Key Capacity.

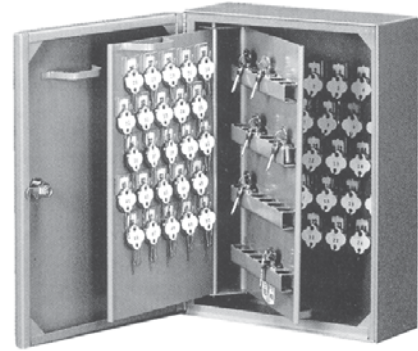

Big Head Wall Mounted

The Big head, designed for hotels and motels, is perfect for storing keys with a large message area. Inside each system, there is space at the rear for either 25 or 50 standard-sized keys. The swinging hook panels are designed to hold Big Head keys without any overlapping or tangling. The doors have no-sag continuous piano-type hinges, and are equipped with pin tumbler locks. Each cabinet is supplied with permanent key tags, temporary key tags, key gathering envelopes, signature receipt forms, hook label strips, instruction booklet and visible index binder.

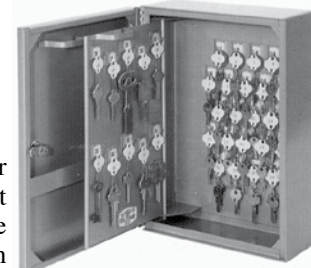

Catalog No.	Keys	Dimensions	Wt.
TBH-45-S	20	16-1/4" H x 12-1/8" W	16
TBH-65-S	40	5" D	20
TBH-86-S	36		32
TBH-122-S	72	27" H x 13" W	38
TBH-159-S	108	7-7/8" D	41
TBH-194-S	144		45

Call for Pricing and Availability