

SECTION 5

DOOR LOCKS - MECHANICAL

Index

A

Amarlock Replacement 30

Door Locks & Deadbolts...Alphabetically by Manufacturer

Electronic Locks 9, 10

Gate Locks 99

H

Handles 4

Handleset Interior Packs 45

Handlesets 47, 77, 100

Header Bolts 5

Hospital Latches 18, 30

I

Indicator Deadbolts 88, 99

Institutional Locks 54

Jimmy Proof Rim Locks 30, 105

L

Latchpulls 3

Leverlocks 23, 25

M

Mechanical Pushbutton Locks 8, 9

See Also: Vendors: Simplex

Mobile Home Locks 48

Mortise Thumb Turns 42

N

Narrow Stile Locks 2, 3, 30, 35, 56, 96

Night Latches 30, 87

P

Paddles 4, 96

Pocket Door Locks 46

Powerbolt 46, 97

Pushbutton Locks 8, 9

Push/Pull Latches 18, 30

DOOR LOCKS - MECHANICAL

R

Rim Deadlocks 30, 105

Rim Locksets 30

Sliding Door Locks 2

T

Threshold Bolts 4

Turnbolts 42, 88, 99

V

Vendors

ADAMS RITE 4-5

ARROW 5-7

CAL ROYAL 10

CODELOCK 8-10

CORBIN RUSSWIN 11-18

DORMA 19-22

ESP 30

FALCON 23-29

KABA ILCO 30-39

KWIKSET 39-49

Kwikset 40-47

KWIKSET LCL 49, 50

LORI 50

MARKS 51-54

MASTER 55

PAPAIZ 56

SARGENT 57-66

SIMPLEX Pushbutton Locks 31-39

S-LINE/NSP 92-95

S. PARKER 91, 106

SARGENT 56-59

SCHLAGE 67-90

WEISER 97-100

YALE 101-105

Narrow Stile Locks

Glass Door Deadbolt

For metal/glass patio doors. Extremely compact stainless steel case with 3-ply stainless bolt - capable of resisting a half-ton force. Bolt is adjustable to compensate for settling door/jamb. Self-protecting feature retracts bolt if door is inadvertently slammed while bolt is in thrown position. Radius ends. Hookbolt design. Case Size: 1/2 x 3-3/16 x 1-1/8".

020-1849	ADA-1847-02	\$61.48
----------	-------------	---------

1847-02



Deadlock

Less cylinders.

Hookbolt design for wood or hollow metal sliding or swinging doors. Has face and mounting flanges for wood or steel preparation.

Case size: 1 x 6".

Face plate: 1-1/4 x 7-13/32.

For 1-1/2" backset lock with ANSI faceplate. Radius face.

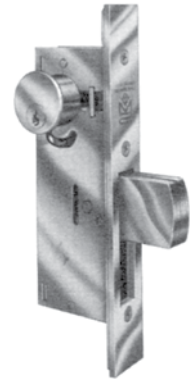

Order #	Item #	Cat. Price
020-1854	MS1851SNSI-410-628	\$102.54

Hookbolt Deadlock MS1851A-050



Less Cylinders

Stainless steel bolt.

Case size: 1 x 6".

Radius Face plate: 1 x 6-7/8".

\$71.92 Each

Order #:	Item #	Backset
020-1860	MS1851S-250-628	31/32"
020-1861	MS1851S-350-628	1-1/8"
020-1862	MS1851S-450-628	1-1/2"



Deadlock MS1851A

Less Cylinders.

Stainless steel bolt,

Strike not furnished.

Case size: 1 x 6". Face plate: 1 x 6-7/8"

Order #:	Item #	Backset	Price
020-1857	MS1851S-210-628	31/32"	\$71.92
020-1858	MS1851S-310-628	1-1/8"	71.92
020-1859	MS1851S-410-628	1-1/2"	71.92

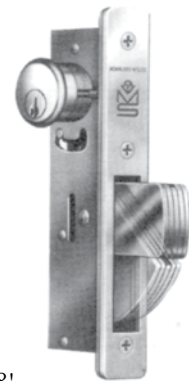

For 1-1/2" backset lock with ANSI faceplate, 1-1/4" X 8".

\$102.54 Each

020-1855	MS1851SNSI-050-450-626.	1-1/2"
----------	-------------------------	--------

NEW

Sliding Door Locks

For wood or metal sliding doors. Single turn of key or thumbturn projects a massive brass bolt then expands two stainless steel dogs behind the heavy brass strike plate.

No self-latching action.

Backset: 1-3/4"

Face size: 1" x 5-3/4"

Case size: 7/8" x 3-5/8" x 2-11/16"

020-2331	2331-26D	\$312.04
----------	----------	----------



2331



4190



Surface Mounted

ADA-4035-01.

Size: 3/8" x 2-3/8" x 27/32"

020-4035 (U)	\$29.90
--------------	---------

Outside Key

ADA-4190-9. For close bypassing, stacked or pocket metal sliders.

020-4190	\$132.24
----------	----------

NEW



ASSA ABLOY

Narrow Stile Locks

Heavy Duty Latch

For metal stile glass doors. Normally fitted with cylinder outside and lever or paddle inside to give one-way traffic control. Can hold the latch retracted, for unrestricted traffic, by reverse turn of the key.

Case size: 1 x 5-13/16".
Face plate: 1 x 6-7/8". Stainless steel bolt.
Latch bolt is white bronze with hardened steel pins. 4502-1 strike.

Less cylinders.

628 Chrome finish:



Order #	Item #	Backset	Hand	Price
020-4507	4511-25-201-628	31/32	RHR	\$79.80
020-4508	4911-35-201-628	1-1/8	RHR	111.94
020-4509	4911-45-201-628	1-1/2	RHR	111.94
020-4511	4511-26-201-628	31/32	LHR	\$79.80
020-4512	4911-36-201-628	1-1/8	LHR	111.94
020-4513	4911-46-201-628	1-1/2	LHR	111.94

Dark brown finish (313):

020-4515	4511-26-201-313	31/32	RHR	\$79.80
020-4516	4911-36-201-313	1-1/8	RHR	111.94
020-4517	4911-46-201-313	1-1/2	RHR	111.94

ADA-1000 Turn

Turn and Escutcheon with 1-1/8" Spindle.
To operate MS1847, 5017, or 4035-10
(without lever) Pushnut mounted.

020-1000	1000-11-21	\$25.86
----------	------------	----------------



ADA-4580 Cam Unit

RH Cam Disc, with cam unit

020-4580	4580-600 RH	\$16.90
----------	-------------	----------------



**Don't see what you need?
Give us a call!
We can get it.**



ASSA ABLOY

Deadlock Lever

Easy unlocking of any MS dead-lock, approx. 3 pounds of downward force on four inch lever. Lever is spring loaded to horizontal, relocks by upward motion from horizontal.

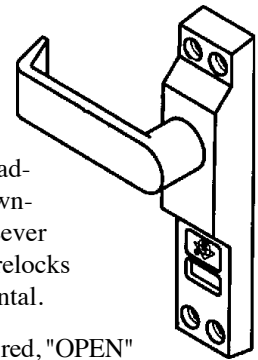

Indicator (Words "LOCKED" in red, "OPEN" in black letters), operated directly by deadlock bolt, signals lock status.

Can be installed in place of existing key cylinder or cylinder type thumbturn on inside of door. Field reversible.

Order #	Item #	Price
020-4550	4550R-01-628 RH	\$199.52
020-4551	4550L-01-628 LH	199.52



ADAMS RITE
MANUFACTURING CO.

Latchpulls

For 1-3/4" thick doors only. RC Exterior locking trim for 4500, 4700, 4900, and 8400 latches



Standard: 4593

Electrified: 4593E -12: 12 Volts

Order #	Item #	Hand	Catalog Price
020-4800	4593-07-RC130	RHR	\$258.68
020-4805	4593-08-RC130	LHR	258.68
020-4810	4593E 07-RC130-12	RHR	365.40
020-4815	4593E 08-RC130-12	LHR	365.40

Handles

Eurostyle Handle:

Operates 4700 series latches.

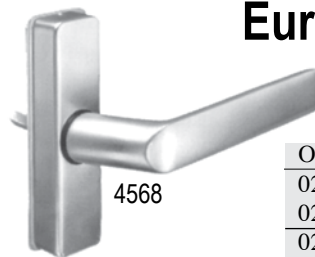

Order #	Hand/Finish	Price
020-4559	LH-628	\$64.72
020-4560	RH-628	
020-4562	RH-313	64.72
020-4564	LH-313	



ASSA ABLOY

Push/Pull Handles

Field Reversible.

Shipped with unaffixed adhesive "Push" & "Pull" plates. 4-3/4" x 3-3/8". Operates any 4700 Series Deadlock.

\$106.48 ea

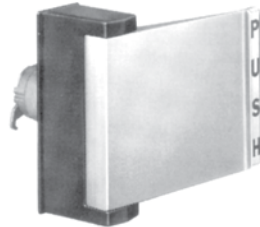

Order #	Item #	Hand
020-4592	4590-02-00-628	LH Push
020-4594	4590-04-00-628	RH Push
020-4596	4590-02-00-313	LH Push
020-4598	4590-04-00-313	RH Push

4591 Deadlatch Paddles

Newly designed paddle is an attractive, ADA friendly alternative to knobs or levers. With its contoured, ergonomic shape and smooth operation, opening a door is as natural as pushing or pulling it. A simple hex key is used for dogging the paddle.

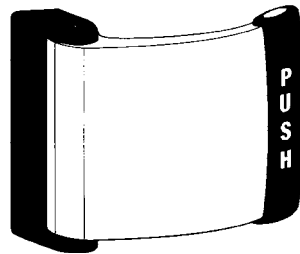

- Works with all backsets latches (except 7/8")
- Standard paddle includes dogging feature
- Monitoring kit can be field installed
- Field changeable for function and hand.(Can be reconfigured to any mode in the field)
- For doors 1-3/4" thick

Furnished for use with Series 4500 or 4700 latches.

Order #	Item #	Catalog Price:
020-1200	4591-02 628 LH Push	\$124.70
020-1205	4591-04 628 RH Push	
020-1210	4591-02 313 LH Push	
020-1215	4591-04 313 RH Push	



ASSA ABLOY

Swinging Door Hardware

Threshold Bolts

4015-18

ANSI/BHMA Type E8241 (Grade 1)

Cylinder Height. Standard threshold bolt rod is sufficient for cylinder height up to 53-7/16". It is fully threaded and can be cut off for low cylinder heights.

Adjustment. Exact adjustment of threaded rod to cylinder height is locked in place by hexagonal threshold bolt.

Strike. For drop-bolt, a 1/2" diameter hole in metal threshold is suitable.

Function. Adding the 4015 bolt to a pivoted bolt MS deadbolt allows Maximum Security for pairs of doors by the turn of a single key. Simultaneously dropping a hardened steel hexbolt into the threshold and pivoting the massive MS bolt into the mating door's stile, the two-point lock secures the entire double door entrance. The 4015 threshold bolt is harnessed to the rear of the pivoted bolt. It may be added to any basic MS1850S or MS1850SN deadbolt.

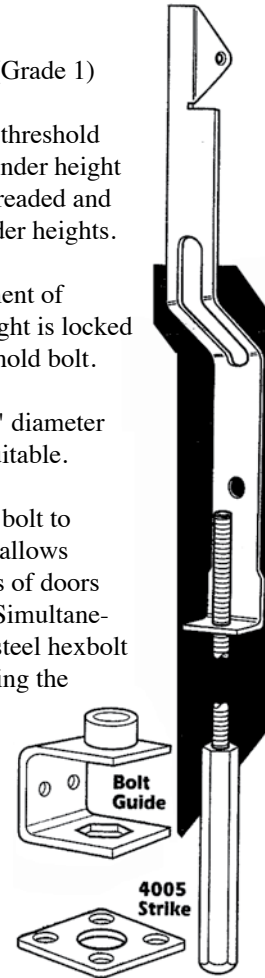

Threshold Bolt. Hexagonal 3/8" flat to flat. Made of hardened steel and plated for corrosion resistance.

Order #	Item #	Catalog Price
020-0035	4015-18	\$43.96



Swinging Door Hardware

Header Bolts. 4016-30-01

Strike. For header bolt, a 1/2" diameter hold in metal frame is suitable.

Adjustment. Exact adjustment of threaded rod to door height is locked in place by hexagonal header bolt.

Door/Cylinder Height. Standard version for a 7' door height with a cylinder height as low as 35". (Can be ORDERED for up to a 10' door with additional extension.)

Function. Adding the 4016 Header Bolt and the 4015 Threshold Bolt to a pivoted MS deadbolt allows for Maximum Security for pairs of doors by the turn of a single key. Simultaneously extending the hardened steel hexbolts top and bottom and pivoting the massive MS deadbolt in to the mating stile, the three-point lock secures the entire double door entrance. The 4016 can be added to any basic MS1850S, MS1850SN or for two-points top and bottom, use with 1870/1870HM Cylinder-Operated Flushbolt. Not applicable to 7/8" backset locks.

Header Bolt. Hexagonal 3/8" flat to flat. Made of hardened steel and plated for corrosion resistance.

Operation. 360° turn of key or thumbturn in basic MS lock throws counterbalanced bolt into opposite door and hexagonal bolt into header strike. Key removed only when bolts are in a positively locked or unlocked position. ANSI/BHMA Type E82111 (Grade 1)



Order #	Item #	Catalog Price
020-0040	4016-30-01	\$55.68

Header Bolt. 4085
Pairs of Doors Only

ANSI/BHMA Type E8261 (Grade 1)

Adjustment. Minor adjustment of rod length is accomplished by turning nylon rod end.

Header Bolt. 1/2" x 1-1/2" expanding bolt with 5/8" throw. Housed in 1-1/2" x 2-3/4" x 5/8" case.

Function. Designed to add a top-of-door third locking point for pairs of doors with an MS pivoted bolt deadbolt and 4015 Threshold bolt in the active leaf. The 4085 is mounted in the inactive leaf. This additional bolt, triggered by the pivoted MS bolt, expands in a "scissors" action to center itself in its strike as it rises. This action saves the key holder from the difficulty of lining up the doors with three separate strikes, even if doors are misaligned due to faulty installation or setting. The three-point features may be added to any basic MS1850S or MS1850SN deadbolt.

Operation. 360° turn of key or thumbturn in basic MS lock throws counterbalanced bolt into opposite door, kicking positioner bolt into header strike (Positioner bolt may be manually thrown before closing active leaf to reduce effort on key-bow.) Key can be removed only when bolts are in a positively locked or unlocked position.

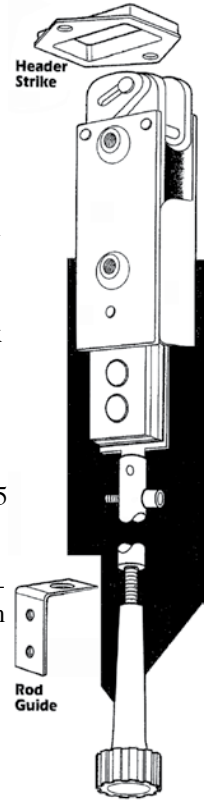

Order #	Item #	Catalog Price
020-0045	4085	\$85.50

ARROW

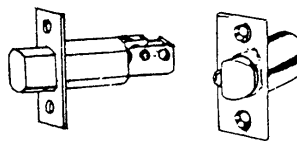

ARROW

Arrow Replacement Bolts

1" throw, for single or double cylinder

\$18.76 ea.
For D & E Series Deadbolts:

Order #	Arrow #	Faceplate	Backset
080-0151	141 26D	1 x 2-1/4	2-3/8
080-0156	141 US3	1 x 2-1/4	2-3/8
080-0155	142 US3	1 x 2-1/4	2-3/4
080-0150	142 26D	1 x 2-1/4	2-3/4
080-0152	144 26D	1-1/8 x 2-1/4	2-3/4
080-0153	145 26D	Drive In Bolt	2-3/8
080-0154	146 -26D	Drive In Bolt	2-3/4

Replacement Latches.

For M Series key-in-knob locks. \$12.04 ea

Order #	Arrow #	Backset
080-0160	111/51-US3	2-3/8
080-0161	111/51-26D	2-3/8
080-0171	114/851-3/4-US3	2-3/4
080-0170	114/851-3/4-26D	2-3/4

ARROW

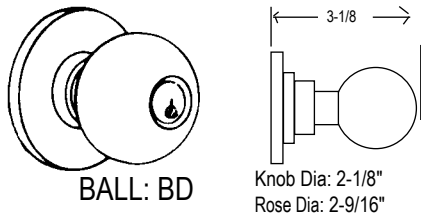
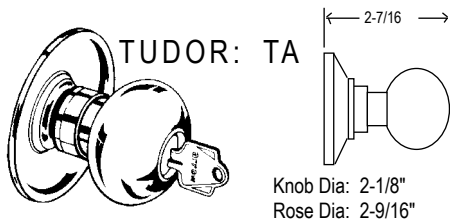

ARROW FUNCTIONS

PASSAGE (01): Latch by knob/lever either side.

PRIVACY (02): Latch by knob/lever either side except when inside pushbutton locks outside knob. Unlock by turning inside knob/lever, closing door or turning outside emergency slot.

ENTRY (11): Latch by knob either side except when pushing turn button locks outside knob/lever. Unlocked by turning inside knob/lever or using key outside. Turning inside button keeps outside knob/lever locked. Key will retract latch.

STOREROOM (12): Latch by inside knob/lever. Outside knob/lever always rigid. Key will retract latch.

CLASSROOM (17): Latch by lever either side except when key locks outside lever.

DORMITORY (19): Latch by knob either side except when outside knob is locked by projecting the deadbolt. Deadbolt by inside turnpiece or outside key. Unlocked by turning inside knob which retracts deadbolt and latchbolt simultaneously. Latchbolt is deadlocked by deadbolt.

ASYLUM (33): Both knobs always rigid; either key will retract latch.

ARROW M Series Standard Duty

- For light commercial applications. • Easily reversible in the field
- Quiet, smooth, dependable operation
- Steel, brass and alloy construction • Made in USA
- Meets ANSI 156.2, Series 4000, Grade 2, requirements
- Conforms to Fed. Specs. FFH-106C, Type 160
- Cold rolled steel & zinc dichromate finish housing resists corrosion
- 1/2" throw brass latchbolt • For door 1-3/8" to 1-3/4" thick

FUNCTION	ITEM #	KNOB	Order # 2-3/8	Order # 2-3/4	Price
PASSAGE	MK01TA-26D	TUDOR	080-0210	-	\$74.52
	MK01BD 5A	BALL	080-0238	-	81.60
	MK01BD 26D	BALL	080-0236	-	74.52
PRIVACY	MK02BD 5A	BALL	(U) 080-0244	-	85.92
	MK02BD 26D	BALL	080-0240	-	78.78
ENTRY	MK11TA-US3	TUDOR	080-0200	080-0201	111.66
	MK11TA-26D	TUDOR	080-0205	080-0207	111.66
	MK11TA-5A	TUDOR	080-0206	-	121.68
	MK11DD-5A	DARRIN	080-0230	-	121.68
STOREROOM	MK12TA-26D	TUDOR	080-0215	080-0218	111.66
	MK12TA-US3	TUDOR	080-0216	080-0219	111.66

ARROW Locks with Schlage "C" Keyway

FUNCTION	ITEM #	KNOB	2-3/8	2-3/4	Price
ENTRY	MK11BD CS 26D	BALL	080-0248	080-0250	111.66
	MK11BD CS 26	BALL	-	080-0257	121.68
	MK11BD CS US3	BALL	080-0263	-	111.66
	MK11BD CS 5A	BALL	-	080-0245	121.68
	MK11BD CS 10B	BALL	-	080-0247	121.68
	MK11TA CS 26D	TUDOR	080-0252	080-0254	111.66
STOREROOM	MK12BD CS 26D	BALL	-	080-0251	111.66
	MK12BD CS 5A	BALL	-	080-0249	121.68
ASYLUM	MK33TA CS 26D	TUDOR	-	080-0220	193.20

Arrow Entry Locks for Interchangeable Core

Furnished less core. 2-3/4" Backset.

Item #	Knob	Order #	Price
ML11TA-IC-26D	Tudor	080-0380	\$169.08
ML11TA-IC-US10B (U)	Tudor	080-0385	179.11

H Series Heavy Duty Locks

Fed. Spec. FFH-106C, Type 160. 2-3/4" backset only. Tudor Knob.

Item #	Function	Order #	Price
H01TB US26D	Passage	080-0231	\$288.72
H11TB US26D	Entry	080-0232	409.38
H11TB US26D	Entry IC (Less Core)	080-0233	409.38

ARROW Sierra Lever Handle Cylindrical Locksets

The answer to accessibility codes, fire codes and security requirements.

Thru-bolting provides high strength for the most demanding applications, 161 prep for retrofit. No exposed screws- meets architects' requirements for aesthetics.

ANSI grade 2 - medium frequency usage.

UL approved for "A" label and lesser doors. Non-handed Door thickness - 1-3/8" - 1-3/4". 2-3/4" Backset.



ITEM #	FUNCTION	Order #	Price
ML01SR-US26D	Passage	080-0295	\$206.10

SCHLAGE "C" KEYWAY:

ML12SR-CS-US26D (U)	Storeroom	080-0330	280.50
ML17SR-CS-US26D (U)	Classroom	080-0345	280.50

ARROW KEYWAY

ML11SR-US26D (U)	ENTRY	080-0270	280.50
------------------	-------	----------	--------

INTERCHANGEABLE CORE, LESS CORE

ML11SR-US26D	ENTRY	080-0350	280.50
ML11SR-US3	(U) ENTRY	080-0355	294.78
ML12SR-US26D	Storeroom	080-0365	280.50

Arrow Grade 2 Deadbolts for IC - Interchangeable Core.

(core not included). 2-3/4" Backset

Single Cylinder

Order #	Item/Finish	Price
080-0400	E61-IC US3	\$80.40
080-0405	E61-IC 26D	80.40

Double Cylinder

080-0420	E62-IC US3	\$93.48
080-0425	E62-IC 26D	93.48
080-0430	E62-IC 10B	103.56

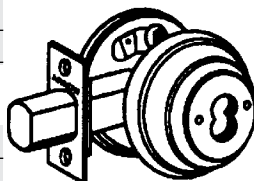

Heavy Duty Deadlock "E" Series

GRADE 2

1" deadbolt with hardened steel pin. For doors 1-3/8" to 1-3/4" thick.

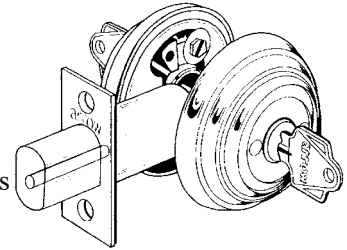

Single Cylinder

Order #	Item #	Backset	Cat. Price
080-1005	E61-US3	2-3/8"	\$56.40
080-1013	E-61-US26D	2-3/8"	56.40
080-1014	E-61-US26D	2-3/4"	56.40
080-1060	E-61-US26	2-3/4"	66.48
080-1016	E-61-US26D	2-3/4" DIB	56.40
080-1009	E-61-5A	2-3/8"	66.48

Double Cylinder

080-1017	E62-US3	2-3/8"	\$69.48
080-1019	(U) E62-US3	2-3/8" DIB	69.48
080-1025	E62-US26D	2-3/8"	69.48
080-1026	E62-US26D	2-3/4"	69.48
080-1021	E62-5A	2-3/8"	79.56

With Schlage Keyways: CS = "C"; ES = "E" Single Cylinder

Order #	Item #	Backset	Cat. Price
080-1080	E61-US3 CS	2-3/8"	\$56.40
080-1082	E61-US3 CS	2-3/4"	\$56.40
080-1085	E61-US26D CS	2-3/8"	\$56.40
080-1087	E61-US26D CS	2-3/4"	\$56.40
080-1088	(U) E61-US26D ES	2-3/4"	\$56.40
080-1090	E61-5A CS	2-3/8"	\$66.48

Double Cylinder

080-1180	E62-US3 CS	2-3/8"	\$69.48
080-1182	E62-US3 CS	2-3/4"	\$69.48
080-1185	E62-US26D CS	2-3/8"	\$69.48
080-1187	E62-US26D CS	2-3/4"	\$69.48
080-1190	E62-5A CS	2-3/8"	\$79.56



We are an authorized ARROW Distributor. If you don't see what you need, give us a call

Codelock Mechanical Pushbutton Locks

CODELOCK 200

The CODELOCK CL200 series of standard duty mechanical pushbutton locks: ideal for restricting access for low usage doors such as storage closets, staff toilets, management offices, valuable inventory areas ... the list goes on. Each CL200 model comes with a hex entry knob and vertical exit lever or thumb turn.

The CODELOCK CL200 has the following available features:

- Fully mechanical - no batteries required
- Easy to install, with all pieces and parts included
- Suitable for interior & exterior use
- Code can be changed quickly, whenever required
- Over 8,000 codes to choose from
- Available in Stainless Steel or Polished Brass finish



CL210 Tubular Deadbolt

Use the CL210 to lock duct doors, store rooms, office doors, or as an auxiliary deadbolt lock on the front, side, garage, or rear door of a residence. Includes a dual backset deadbolt with hardened roll-pin for both 2 3/8" and 2 3/4" backsets. Optional CP161 cover plate required when replacing an existing cylindrical knobset lock (covers 2 1/8" hole).

CL250 Tubular Deadlatch

The CL250 includes a dual backset deadlatch that always locks when the door is closed. Convenient vertical lever handle on the back-plate. This is the best selling lock we make! Includes a dual backset latchbolt for both 2 3/8" and 2 3/4" backsets. Optional CP161 cover plate required when replacing an existing cylindrical knobset lock (covers 2 1/8" hole). SS: Stainless Steel; PB: Polished Brass.

Order #	Item #	Catalog Price
182-0210	CL210SS	\$168.00
182-0211	CL210PB	168.00
182-0250	CL250SS	180.00
182-0251	CL250PB	180.00
182-0255	CL250KSS	192.00
182-0260	CL250KPB	192.00



CODELOCK CL400 Series

A medium duty mechanical pushbutton lock with full size lever handles. The lever handles allow it to be used where the knob operated pushbutton lock is unsuitable.

The levers are in compliance with safety and public access requirements.

Several functions are available to

allow for control of the door in a variety of ways for office, educational, local or federal government organization, or other medium duty commercial and residential applications.

The CODELOCK CL400 has the following available features:

- Optional code free entry mode by pressing passage set button after entering the code (CL415 only)
- Inside handle always retracts the latch for exit
- Weather resistant
- Tough PVD (Physical Vapour Deposition) lifetime finishes - Stainless Steel and Polished Brass
- Sturdy construction with stainless steel buttons, and clutch protection if the outside handle is forced
- Reversible handles, non-handed
- Easy code change as often as required
- Fits doors between 35mm and 60mm thick without modification, standard with 2 3/8" or optional 2 3/4" backset deadlocking latchbolts.
- Available with Back-to-Back option for code in, code out applications (pool gates)

CL415 - Includes Tubular Deadlatch

Model 415 - With 'code free' Passage Mode entry option

Order #	Item #	Catalog Price
182-0415	CL415SS	\$240.00
182-0416	CL415PB	240.00

DOOR LOCKS

Codelock Mechanical Pushbutton Locks

CODELOCK CL500 Series

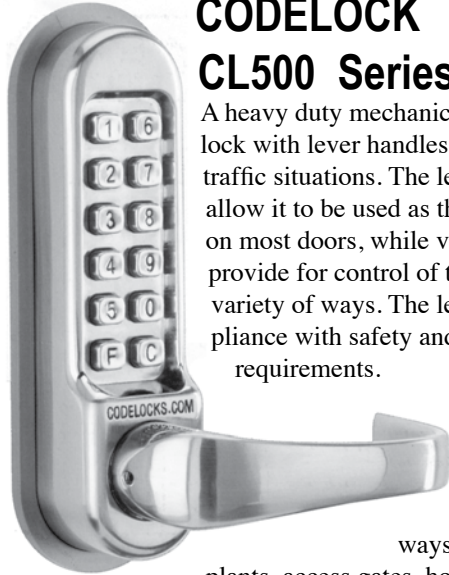

A heavy duty mechanical pushbutton lock with lever handles for use in high traffic situations. The lever handles allow it to be used as the primary lock on most doors, while various functions provide for control of the door in a variety of ways. The levers are in compliance with safety and public access requirements.

Tough enough to control heavily accessed doors in a variety of ways for industrial

plants, access gates, hospitals, colleges and universities, commercial offices, local or federal government organizations, or other heavy duty commercial and multi tenant residential facilities.

CODELOCK CL500 has the following available features:

- Full size heavy duty lever handles
- Commercial grade 2-3/4" (70mm) backset deadlocking latch bolt
- Optional heavy duty, Grade 1, fire rated mortise lock chassis with deadlocking latch bolt
- Code free entry with optional passage mode
- Panic/Safety function - inside lever handle opens door
- 2047 codes to choose from
- Available in hardwearing PVD Stainless Steel or Polished Brass finishes
- Available in back to back code-in code-out function for special applications

CL510/515 - Tubular Deadlatch

The Model CL510/515 has a tubular, deadlocking, latchbolt and may be used as a new installation on a door, or where an existing latch is to be replaced. The CL515 includes the passage mode option for code-free entry. An included CP161 cover plate is required when replacing an existing cylindrical knobset lock (covers 2 1/8" hole). Weld lock box for gates is available.

Order #	Item #	Catalog Price
182-0515	CL515SS	\$360.00
182-0516	CL515PB	360.00

CODELOCK

Knobset Coverplate

CP161 cover plate required when replacing an existing cylindrical knobset lock.

Covers 2 1/8" hole.

Order #	Item #	Catalog Price
182-0161	CP161SS	\$30.00
182-0162	CP161PB	30.00

Codelock Electronic Locks



CL4000

Medium Duty Electronic Codelock

Intended for use where a smaller, slim line entry control lock is appropriate. Has the same operational and programming specifications as the CL5000 including key and code activated passage mode.

Order #	Item #	Catalog Price
182-4000	CL4000SS	\$408.00

Codelock Electronic Locks

CODELOCK
CL5000 Series

A heavy duty electronic pushbutton lock with lever handles for use in high traffic situations. The lever handles allow it to be used as the primary lock on most doors, while various functions provide for control of the door in a variety of ways. The levers are in compliance with safety

and public access requirements.

Tough enough to control heavily accessed doors in a variety of ways for industrial plants, access gates, hospitals, colleges and universities, commercial offices, local or federal government organizations, or other heavy duty commercial and multi tenant residential facilities.

The Piezo actuator, used for the first time in a stand alone electronic lock, provides a battery life of over 500,000 operations (approximately ten times more than a typical electronic push button lock that uses a solenoid or motor drive actuator).

The CODELOCK CL5000 Series has the following available features:

- A simple and cost effective access solution
- 500,000 Operations from 4 x AA cells, batteries included
- Easy installation and programming
- 90 different user codes of 4, 5, or 6 digits long
- Reliable - Solid state Piezo technology
- Durable - Tested to over 1,000,000 cycles @ 2.4 Nm
- Weather resistant Physical Vapour Deposition finish
- Remote push button and Emergency Alarm release connections
- Optional ANSI Grade 1 Mortise Chassis
- Available in Stainless Steel/Black Chrome/Polished Brass finishes

CODELOCK CL5010/CL5050 electronic leverset complete with heavy duty 2 3/4" tubular deadlocking latchbolt or heavy duty ANSI Grade 1 mortise lock chassis (5050). Supplied with all required parts, installation templates and instructions to give convenient flexible access control.

Order #	Item	Catalog Price
182-5000	CL5000SS	\$528.00

Cal Royal

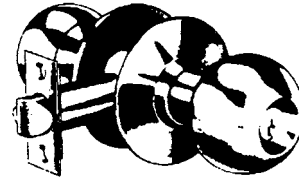

Grade 2,
2-3/4" backset,
ASA strike,
Ball Knob, Schlage "C"
on keyed functions.

Order #	Item/Function	Catalog Price
279-0010	BA-30 10B Passage	\$32.28
279-0040	BA-20 10B Privacy	40.22
279-0050	BA-00 10B Entry	54.24
279-0080	(U) BA-05 10B Storeroom	54.24

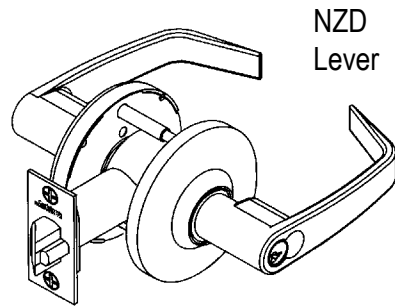

Show with cylinder (order separately)

Extra Heavy Duty Cylindrical Lever Locksets

Grade 1, Less Cylinders (LC) - order below.

- Non-handed
- 1-3/4" to 2" Door Thickness
- 2-3/4" Backset
- ANSI Straight Lip Strike. 4-7/8" x 1-1/4" lip to center
- Lever: Die cast Zinc. Rose: Brass or Bronze

Order #	Item #	Description	Cat.\$
195-3310	CL3310 NZD 626	Passage	\$308.00
195-3320	CL3320 NZD 626	Privacy	354.00
195-3351	CL3351 NZD 626 LC	Entry	365.00
195-3357	CL3357 NZD 626 LC	Storeroom	365.00
195-3300	CL3355 NZD 626 LC	Classroom	365.00

CL3300 Cylinders for above locks- conventional 6-Pin

Order #	Item #	Keyway	Cat.\$
195-6000	2000-033 626	L4	\$56.40
195-6005	2000-033 626	981	56.40
195-6010	2000-033 626	D1	56.40

**DON'T SEE WHAT YOU NEED?
GIVE US A CALL.**

Standard Duty Key- In-Lever Locksets CL3900 Series

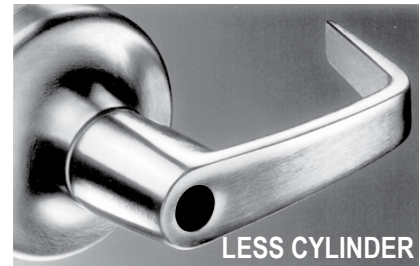

Newport Lever

Complies with codes requiring lever to return to within 1/2" of door face.

Die cast zinc lever.
2-3/4" Backset.

LESS CYLINDER.

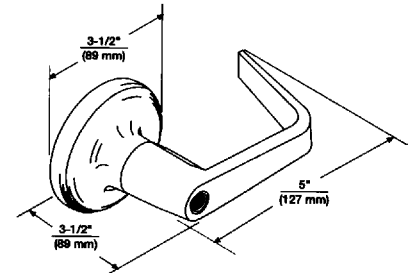

Order #	Item #	Price
195-3951	CL3951 NZD 626 Entrance or Office. ANSI F81/82	\$255.60
195-3955	CL3955 NZD 626 Classroom. ANSI F84	255.60
195-3957	CL3957 NZD 626 Storeroom or Closet. ANSI F86	255.60

Finishes: 626: Satin Chrome
630: Satin Stainless Steel
605: Bright Brass

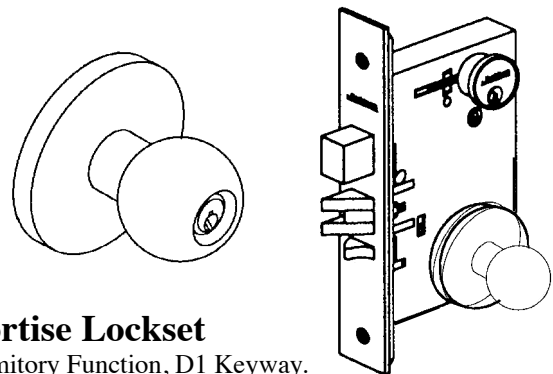

Mortise Lockset

Dormitory Function, D1 Keyway.

Field reversible; for 1-3/4" door thickness. 2-3/4" backset with ANSI straight lip strike.

195-2010	COR ML2265 GRC 630	\$735.60
----------	--------------------	-----------------

Mortise Locksets ML2000 Series

FUNCTIONS

Outside	Inside	Series/ Function	Type	ANSI No. Series 1000	Function Description
		ML2011	Deadlock	F18	- Deadbolt by key outside. - No inside operation.
		ML2012	Deadlock	F16	- Deadbolt by key either side.
		ML2013 	Classroom	F17	- Deadbolt by key outside or by thumbturn lever inside.
		ML2017	Classroom Deadlock	—	- Deadbolt by key outside. - Thumbturn lever inside retracts deadbolt only; will not project deadbolt.
		ML2010 	Passage or Closet	F01	- Latchbolt by grip either side. - Both grips always free.
		ML2022 	Store Door	F14	- Latchbolt by grip* either side. - Deadbolt by key either side.
		ML2024 	Entrance or Storeroom	F21	- Latchbolt by grip* either side. - Deadbolt by key outside or by thumbturn lever inside.
		ML2029 	Hotel or Motel	F15	- Latchbolt by grip inside and by guest key or master key outside. - Outside grip always rigid. - Deadbolt by thumbturn lever inside or by emergency key outside. - Inside grip simultaneously retracts latchbolt and deadbolt. - Emergency key shuts out all other keys. - Auxiliary latch deadlocks latchbolt.
		ML2030 	Privacy Bedroom or Bathroom	F19	- Latchbolt by grip either side. - Deadbolt by thumbturn lever inside or by emergency release tool outside. - Inside grip simultaneously retracts latchbolt and deadbolt.
		ML2032	Institution or Utility	—	- Latchbolt by key either side. - Both grips always rigid. - Auxiliary latch deadlocks latchbolt.

Indicates availability in ML2000HS.

Indicates rigid grip.











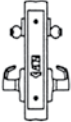



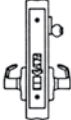

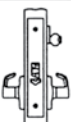



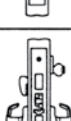

* When lever handles are furnished, both outside and inside are locked when deadbolt is projected.

**Corbin
Russwin**

A member of the
Yale Security Group

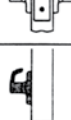
Mortise Locksets ML2000 Series

FUNCTIONS

Outside	Inside	Series/ Function	Type	ANSI No. Series 1000	Function Description
		ML2042	Entrance or Public Restroom	09	- Latchbolt by grip either side, unless outside grip is locked by master key** from inside. - Latchbolt by key outside or by grip inside. - Auxiliary latch deadlocks latchbolt. - Inside grip always free.
		ML2048	Entrance or Apartment	F10	- Latchbolt* by key outside or by grip either side, unless outside grip is locked by toggle-action stop. - Deadbolt by key outside or by thumbturn lever inside. - Inside grip always free.
		ML2051	Entrance or Office	F04	- Latchbolt by key outside or by grip either side, unless outside grip is locked by toggle-action stop. - Auxiliary latch deadlocks latchbolt. - Inside grip always free.
		ML2055	Classroom	F05	- Latchbolt by grip either side, unless outside grip is locked by key outside. - Auxiliary latch deadlocks latchbolt. - Inside grip always free.
		ML2057	Storeroom or Closet	F07	- Latchbolt by grip inside or by key outside. - Outside grip always rigid. - Auxiliary latch deadlocks latchbolt. - Inside grip always free.
		ML2060	Privacy	F22	- Latchbolt by grip either side, except when outside is locked by thumbturn inside. - Operating inside grip, closing door or operating emergency key outside unlocks outside grip.
		ML2065	Dormitory, Entrance or Storeroom	F13	- Latchbolt by grip either side. - Deadbolt by key outside or by thumbturn lever inside. - Inside grip simultaneously retracts latchbolt and deadbolt.
		ML2067	Apartment or Dormitory	F12	- Latchbolt by grip either side, unless outside grip is locked by toggle-action stop or by projection of deadbolt. - Deadbolt by key outside or by thumbturn lever inside. - Inside grip simultaneously retracts latchbolt and deadbolt; outside grip remains locked. - Auxiliary latch deadlocks latchbolt.
		ML2069	Institutional Privacy	—	- Latchbolt by grip either side, except when outside is locked by thumbturn inside. - Operating inside grip or closing door unlocks outside grip. - Key outside retracts latch at all times, even if thumbturn is held in locked position. - Auxiliary latch deadlocks latchbolt.
		ML2050	Half Dummy Trim	—	- Grip acts as pull only; no operation.
		ML2070	Full Dummy Trim	—	- Grips act as pulls only; no operation.

**Corbin
Russwin**A member of the
Yale Security Group

Indicates rigid grip.



Indicates availability in ML2000HS.



* When lever handles are furnished, both outside and inside are locked when deadbolt is projected.
** When so specified, change key will be furnished to operate inside cylinder.

FUNCTIONS

CL3300: Grade 1
CL3800: Grade 2

Outside	Inside	Series/ Function	Type	ANSI No. Series 4000	Function Description
		CL3310 CL3810	Passage or Closet	F75	- Latchbolt by lever either side. - Both levers always free.
		CL3320 CL3820	Privacy, Bedroom or Bathroom	F76	- Throw-off latchbolt by lever closing door or by turning inside lever. - Outside lever locked by push button. (Lever handle is freewheeling in locked position.) - Outside lever unlocked by emergency release tool outside, by rotating inside lever or by closing door. - Inside lever always free.
		CL3329	Hotel or Motel	F93	- Throw-off latchbolt by lever inside or by key outside. - Push button shuts out all keys except emergency key, and projects occupancy indicator in face of cylinder. (Lever handle is freewheeling in locked position.) - Push button released by turning inside lever or by closing door.* - Outside lever always locked. - Inside lever always free.
		CL3332 CL3832	Institutional or Utility	F87	- Deadlocking latchbolt by key either side. (Lever handle is freewheeling in locked position.)
		CL3340 CL3840	Patio or Privacy	F77	- Throw-off latchbolt by lever closing door or by turning inside lever. - Outside lever locked by push button. (Lever handle is freewheeling in locked position.) - Inside lever always free. - Should not be used in rooms that have no other entrance.
		CL3340NT CL3840NT	Exit Latch	F89	- Deadlocking latchbolt by lever inside. - Outside lever always locked. (Lever handle is freewheeling.) - Inside lever always free.
		CL3351 CL3851	Entrance or Office	F109	- Deadlocking latchbolt by lever either side, except when turn button locks outside lever. Pushing turn button in locks outside lever, requiring use of key outside to unlock. (Lever handle is freewheeling in locked position.) - Turning inside lever unlocks outside lever. - Pushing in and turning button locks outside lever, requiring key at all times. Turning inside lever does not unlock outside lever until button is manually turned to unlocked position. - Inside lever always free.
		CL3352	Classroom Intruder	—	- Latchbolt is operated by rotating the inside lever, or rotating the outside lever only when not locked from the inside or outside by key. - Outside lever is locked and unlocked by turning the key in the inside or outside lever. - Inside lever cannot be locked.
		CL3355 CL3855	Classroom	F84	- Deadlocking latchbolt by lever either side, except when key outside locks outside lever. (Lever handle is freewheeling in locked position.) - Outside lever unlocked by key outside. - Inside lever always free.
		CL3357 CL3857	Storeroom or Closet	F86	- Deadlocking latchbolt by key in outside lever or by rotating inside lever. (Lever handle is freewheeling in locked position.) - Inside lever always free.
		CL3361 CL3861	Entry or Office	F82	- Deadlocking latchbolt by lever either side, except when push button locks outside lever. - Push button released by turning inside lever or by key in outside lever. (Lever handle is freewheeling in locked position.) - Closing door does not release push button. - Inside lever always free.



 Indicates optional interchangeable core available; see Quick Codes, page 14.
 Indicates freewheeling lever in locked position.







*Unless push button has been fixed in locked position by spanner key (furnished). When push button is fixed by spanner key, lock is operable only by emergency key or by display key.

DOOR LOCKS

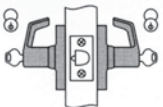
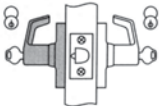
FUNCTIONS

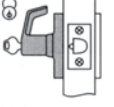
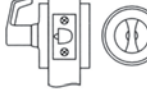
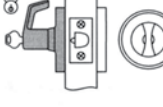
CL3300: Grade 1

CL3800: Grade 2

Outside	Inside	Series/ Function	Type	ANSI No. Series 4000	Function Description
		CL3362 CL3862	Communicating	F80	<ul style="list-style-type: none"> - Deadlocking latchbolt by lever either side, except when key in either lever locks and unlocks the lever independently of the other. (Lever handle is freewheeling in locked position.) - Keyed alike unless otherwise specified. - Should be used only in office or room with multiple entries.
		CL3372 CL3872	Apartment, Exit or Public Toilet	F88	<ul style="list-style-type: none"> - Deadlocking latchbolt by lever either side, except when key inside locks outside lever. (Lever handle is freewheeling in locked position.) - Key outside retracts latchbolt. - Key inside unlocks outside lever. - Inside lever always free. - Keyed alike unless otherwise specified.
		CL3380 CL3880	Passage Lever x Blank Plate	—	<ul style="list-style-type: none"> - Deadlocking latchbolt by lever. - Lever on one side; blank plate on other side. - Lever always free. - For single or double communicating doors.
		CL3381 CL3881	Keyed Lever x Blank Plate	—	<ul style="list-style-type: none"> - Deadlocking latchbolt by lever, except when lever is locked by key. (Lever handle is freewheeling in locked position.) - Lever on one side; blank plate on other side.
		CL3390 CL3890	Passage Lever x Turnpiece	—	<ul style="list-style-type: none"> - Latchbolt by lever or by turnpiece. - Lever on one side; turnpiece on other side. - Lever and turnpiece always free.
		CL3391 CL3891	Keyed Lever x Turnpiece	—	<ul style="list-style-type: none"> - Deadlocking latchbolt by lever or turnpiece, except when lever is locked by key. - When lever is locked, latchbolt is operated by key in lever or by turnpiece. (Lever handle is freewheeling in locked position.) - Lever on outside; turnpiece on inside. - Turnpiece always free.
		CL3393 CL3893	Service Station	F92	<ul style="list-style-type: none"> - Throw-off latchbolt by lever closing door or by turning inside lever. - Outside lever locked by slotted push button. (Lever handle is freewheeling in locked position.) - When slotted push button is pushed in and turned, outside lever becomes freewheeling and deadlocking latch is activated. Outside lever is unlocked by using key or by rotating inside lever. - Inside lever always free.
		CL3350 CL3850	Half Dummy Trim	—	<ul style="list-style-type: none"> - Lever acts as pull only; no operation. - Lever is rigid.
		CL3370 CL3870	Full Dummy Trim	—	<ul style="list-style-type: none"> - Levers act as pulls only; no operation. - Lever is rigid.



Indicates freewheeling lever in locked position.



Indicates optional interchangeable core available; see Quick Codes, page 14.

DOOR LOCKS



NOTE:

A complete Corbin Russwin mortise lock consists of a (1) lock body, (2) trim, and (3) cylinder.

Order all three parts.

1. Order Lock Body:

Lock Bodies.

Front and Strike included.
Order Trim Separately

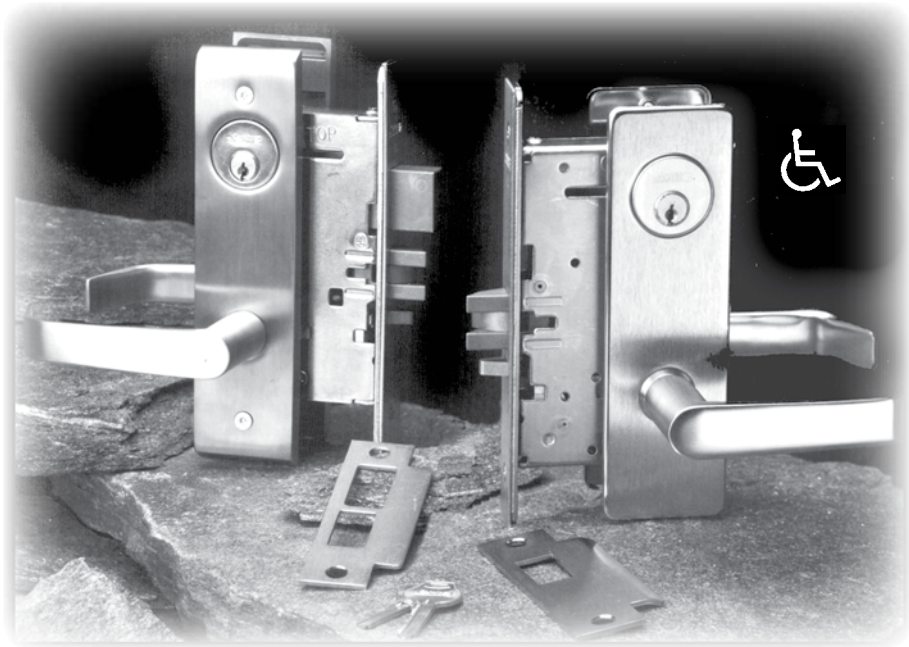

**ML2000 Series
Mortise Locksets**



Designed to meet the rigors of high-traffic commercial, institutional, industrial, and government applications.

Key Advantages

- Patented Quick Reversible feature enables reversal of hands without disassembling the lock case.
- Security trims provide a vandal-resistant barrier
- Can be used with new or existing Corbin Russwin key systems. Also accepts cylinders of most other manufacturers.
- Provides life safety and security in a single door prep
- Through-bolted trim designs for proper alignment and increased security.
- Heavy-gauge chrome plated steel
- 2-3/4" backset, for 1-3/4" standard door thickness

Certification/Compliance

- ANSI A156.13 Series 1000, Operational and Security Grade 1. Meets A117.1 Accessibility Code.
- Meets FF-H-106C.UL/ULC-UL10C Positive Pressure

Verify function from charts on previous pages.

Order #	Item #	Supplier #	Cat. Price
195-7000	COR #1	ML2055LL 626 ML2055 Classroom ML2042 Entrance or Public Restroom	\$223.20
195-7005	COR #2	ML2057LL 626 Storeroom	223.20
195-7010	COR #3	ML2051LL 626 Entrance/Office	223.20
195-7015	COR #4	ML2065LL 626 ML2065 Dormitory ML2030 Privacy	241.20
195-7020	COR #5	ML2067LL 626 Apartment/Dormitory	241.20
195-7025	COR #6	ML2010LL 626 Passage	192.60
195-7030	COR #7	ML2024LL 626 ML2024 Entrance ML2020 Privacy	241.20
195-7035	COR #8	ML2072LL 626 ML2072 Classroom ML2075 Classroom	223.20
195-7040	COR #9	ML2032 Institution ML2032 Utility	223.20



2a. Choose Trim:



LWA

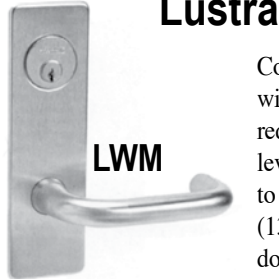
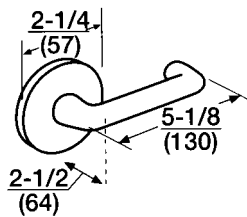

LWMA

LWM

Complies with codes requiring lever to return to within 1/2" (13mm) of door face.

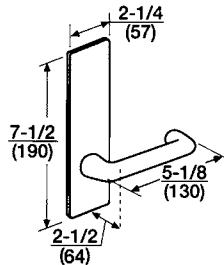

Lustra

LWA - Lever: Wrought, Rose: Wrought

LWM - Lever: Wrought, Escutcheon: Wrought

Newport



NSA

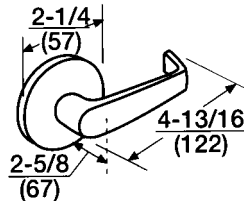

NSM



NSN

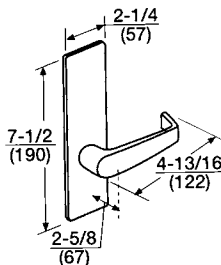

Newport

Complies with codes requiring lever to return to within 1/2" (13mm) of door face.

NSA - Lever: Cast, Rose: Wrought

NSM - Lever: Cast, Escutcheon: Wrought

NSN - Lever: Cast, Escutcheon: Wrought



RWA

Regis

• Lever: Wrought, Rose: Wrought

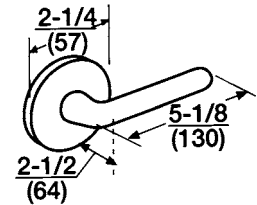

2b. Order Trim:

To complete a mortise lockset, order from the trim packages below.



Mortise Trim Packages

• Include all fasteners. Satin chrome finish

Functions: ML2055, 2057, 2051, 2010, 2072

Order #	Item #	Design	Cat. Price
195-8000	TRIM #20 NSA 626	Newport	\$372.60
195-8100	TRIM #23 LWA 626	Lustra	287.10
195-8200	TRIM #26 NSN 626	Newport	379.80
195-8300	TRIM #29 NSM 626	Newport	379.80
195-8400	TRIM #32 LWM 626	Lustra	293.40
195-8500	TRIM #35 RWA 626	Regis	287.10

Functions: ML2065, 2067, 2024

195-8005	TRIM #21 NSA 626	Newport	\$372.60
195-8105	TRIM #24 LWA 626	Lustra	287.10
195-8205	TRIM #27 NSN 626	Newport	379.80
195-8305	TRIM #30 NSM 626	Newport	379.80
195-8405	TRIM #33 LWM 626	Lustra	293.40
195-8505	TRIM #36 RWA 626	Regis	287.10

Functions: ML2030, ML2020

195-8010	TRIM #22 NSA 626	Newport	\$372.60
195-8110	TRIM #25 LWA 626	Lustra	287.10
195-8210	TRIM #28 NSN 626	Newport	379.80
195-8310	TRIM #31 NSM 626	Newport	379.80
195-8410	TRIM #34 LWM 626	Lustra	293.40
195-8510	TRIM #37 RWA 626	Regis	287.10

3. Order Cylinders:

All mortise lock bodies are less cylinder.

Order cylinders separately

See our catalog, Section 14 for a large selection of Corbin Russwin cylinders.

Extra Heavy Duty Locksets.

Heavy Duty Cylindrical Knob Locksets CK4200 Series.

Field Reversible; for doors 1-3/4" to 2" thick. 2-3/4" backset; ANSI curved lip strike.

Federal Specs:

Conforms to Federal Specification FF-H-00106b. type 161.

Zinc and dichromate plated for corrosion and friction resistance.

UL Listed for all classes of labeled doors.

ANSI Specs: ANSI A156.2-1983 Grade 1 requirements.

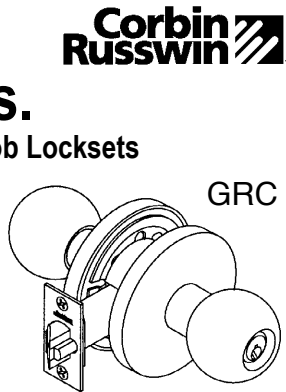

4251. Entrance and Office Doors

Latch bolt by knob either

side unless outside knob is locked by turn button inside. Key retracts latch bolt when outside knob is locked. Auxiliary latch deadlocks latch bolt.

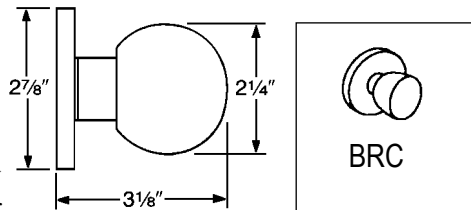

4255. Classroom Doors.

Latch bolt by knob either side unless outside knob is locked by key. Inside knob always free. Auxiliary latch deadlocks latch bolt. 2-3/4" Backset.

Passage Set

195-2000	(U) CK4210 GRC 630	\$487.20
----------	--------------------	----------

Entry Lockset 6D1 Keyway

195-2025	CK4251 BRC 626 IC Core	\$652.80
196-0005	CK4251 GRC 626	\$500.00

Classroom Lockset 6D1 Keyway

196-0010	CK4255 GRC 626	\$500.00
----------	----------------	----------

Corbin
Russwin

Corbin
Russwin

CORBIN RUSSWIN Hospital Latches, Push/Pull Latches

Modern design push-pull set is operated by a simple push from one side and a pull from the other.

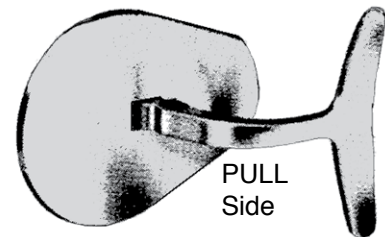

Primarily designed for hospital use, it may be used on any door requiring push-pull operation.

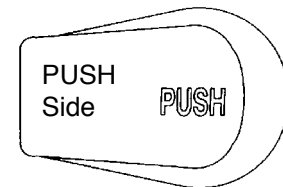

- Reversible. 5" backset.
- Use on 1-3/4" doors only.
- U.L. Listed for Classes A, B, C, D and E labeled doors.
- Escutcheons: 6-1/2" x 5".
- Projection: Pull lever- 3-3/4"; Push lever- 1-3/4".

Order #	Item #	Price
195-0588	860-26D	\$733.60

Heavy Duty Dead Latches

\$63.00 ea.

Corbin
Russwin

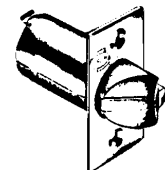

2-1/4 x 1" Front.

486F89 Heavy Duty Deadlatch

2-3/4" Backset

195-0032	26D	75.00
----------	-----	-------

CL800 Series Grade 1 Heavy-Duty Cylindrical Locksets



Provide exceptional security, enhanced aesthetics, and rugged dependability.

These premium locks are built with a high performance cylindrical chassis for all applications where ANSI A156.2 Series 4000 Grade 1 products are required. Made in USA.

- Installs in ANSI A115 door prep.
- Freewheeling function to protect the lock from damage caused by excessive torque applied to the lever handles. When locked, the outside lever will move freely through a 60° arc without operating the latch bolt. Minimizes damage to the lock mechanism.
- High strength spring & positive stop to eliminate unsightly sagging levers.
- Cast stainless steel retractor combined with bronze roller bearings providing high strength and extended service life.
- Through bolted for additional strength and reliability.
- Include a special breakaway function to maintain security when the lever handles are attacked.
- 2-3/4" backset, 1/2" throw. For doors 1-3/4" thick.
- Reversible handing

Certification:

The Dorma CL800 is U.L. and C.U.L listed, three hour fire rated. 1/2" throw bolts are listed for A label and lesser class single doors, 4'0" x 10'0" maximum. Certified to the requirements of ANSI A156.2 Series 4000 Grade 1. Meets A117.1 and ADA requirements. Manufactured in the USA. California State Fire Marshall (CSFM) approved, California State Reference code, 1989 (formerly title 19). Other Listings: MEA.

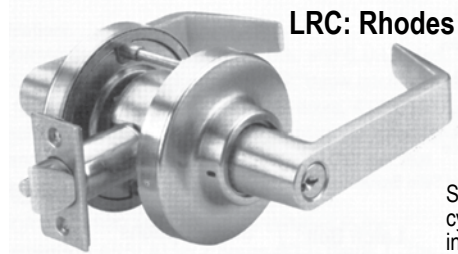
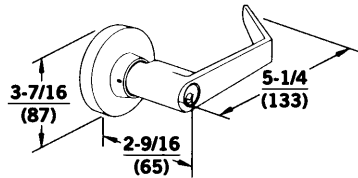

Shown with cylinder installed

L: Less Cylinder (Ex: CL853L)
J: Less Interchangeable Core (Ex: CL853J)

Order #	Item #	Function	Cat. Price
231-0810	CL810 LRC 626	Passage	\$248.40
231-0840	CL840 LRC 626	Privacy	291.60
231-0853	CL853L LRC 626	Entry	309.60
231-0870	CL870L LRC 626	Classroom	309.60
231-0877	CL877L LRC 626	Classroom Intruder	337.50
231-0880	CL880L LRC 626	Storeroom	309.60
231-0953	CL853J LRC 626	Entry	342.00
231-0970	CL970J LRC 626	Classroom	342.00
231-0977	CL877J LRC 626	Classroom Intruder	402.30
231-0980	CL880J LRC 626	Storeroom	342.00

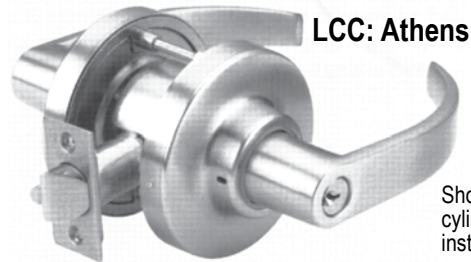

Shown with cylinder installed

Order #	Item #	Function	Cat. Price
231-1810	CL810 LCC 626	Passage	\$248.40
231-1840	CL840 LCC 626	Privacy	291.60
231-1853	CL853L LCC 626	Entry	309.60
231-1870	CL870L LCC 626	Classroom	309.60
231-1877	CL877L LCC 626	Classroom Intruder	337.50
231-1880	CL880L LCC 626	Storeroom	309.60
231-1953	CL853J LCC 626	Entry	342.00
231-1970	CL870J LCC 626	Classroom	342.00
231-1977	CL877J LCC 626	Classroom Intruder	402.30
231-1980	CL880J LCC 626	Storeroom	342.00



LRC: Rhodes

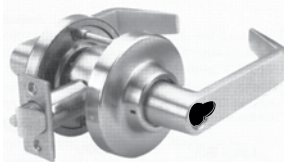

Rhodes Style Lever,

Prepared for Schlage LFIC, Less Core.

Order #	Item #	Function	Cat Price
231-0653	CL853R LRC 626	Entry	\$346.50
231-0670	CL870R LRC 626	Classroom	331.30
231-0680	CL880R LRC 626	Storeroom	331.30



**CL700 Series
Grade 2 Cylindrical Locksets**

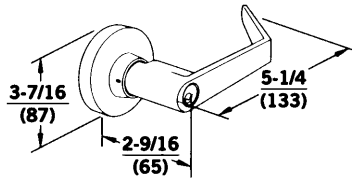

LRC Rhodes

Provide exceptional security, enhanced aesthetics, and rugged dependability.

These key-in-lever locksets are built with a high performance cylindrical chassis for all applications where ANSI A152.2 Series 4000 Grade 2 products are required.

- Easy to install in both wood or hollow metal doors with ANSI Standard A115 prep for cylindrical locks.
- Include special spring assemblies designed to hold the levers in the correct position.
- Through-bolted for additional strength
- Accommodate doors from 1-5/8" to 1-7/8" thick.
- Reversible handing
- Auxiliary deadlocking latch bolt prevents manipulation when door is closed

L: Less Cylinder (Ex: CL753L)
J: Less Interchangeable Core (Ex: CL753J)
S: SC1 Cylinder with two keys (Ex: CL753S)

Certification:

The Dorma CL700 is U.L. and C.U.L listed, three hour fire rated. 1/2" throw bolts are listed for A label and lesser class single doors, 4'0" x 10'0" maximum. Certified to the requirements of ANSI A156.2 Series 4000 Grade 2. Meets A117.1 and ADA requirements. California State Fire Marshall (CSFM) approved, California State Reference code, 1989 (formerly title 19). Other Listings: MEA.

Order #	Item #	Function	Cat. Price
231-0710	CL710 LRC 626	Passage	\$150.30
231-0740	CL740 LRC 626	Privacy	169.20
231-0753	CL753L LRC 626	Entry	185.40
231-0001	CL753S LRC 626	Entry	217.80
231-0770	CL770L LRC 626	Classroom	185.40
231-0780	CL780L LRC 626	Storeroom	185.40
231-0755	CL753J LRC 626	Entry	217.80
231-0775	CL770J LRC 626	Classroom	217.80
231-0785	CL780J LRC 626	Storeroom	217.80

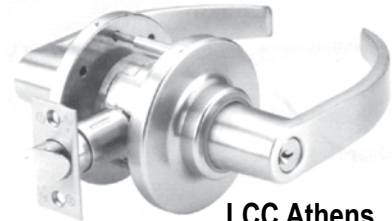

LCC Athens

Order #	Item #	Function	Cat. Price
231-1710	CL710 LCC 626	Passage	\$150.30
231-1740	CL740 LCC 626	Privacy	169.20
231-1753	CL753L LCC 626	Entry	185.40
231-1770	CL770L LCC 626	Classroom	185.40
231-1780	CL780L LCC 626	Storeroom	185.40
231-1755	CL753J LCC 626	Entry	217.80
231-1775	CL770J LCC 626	Classroom	217.80
231-1785	CL780J LCC 626	Storeroom	217.80



Cylinders

0-Bitted. D100 Keyway



1-1/8 Mortise Cylinder,

Order #	Item #	Catalog Price
231-5100	90B10D 100 626	\$49.20

Key in Knob/Lever Cylinder.

231-5200	70AP D100 626	49.20
----------	---------------	--------------

Rim Cylinder

231-5300	80R40 D100 626	49.20
----------	----------------	--------------

IC Small Format Core,

Uncombined. Keys Not Included

231-5400	77 D100 626	31.20
----------	-------------	--------------



Keying Accessories

Pin Kit for Dorma

D100 Keyway Conventional and IC Cylinders

231-5500	76007399	\$382.80
----------	----------	-----------------

Card for HPC/ILCO

Universal Code Machine, D100 Keyway

231-5700	7601007	28.80
----------	---------	--------------

Manual Capping Set

For D100 Small Format IC Cores.

231-5600	7601007	216.00
----------	---------	---------------

DOOR LOCKS

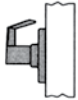
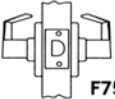
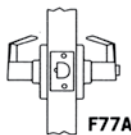
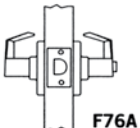
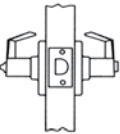
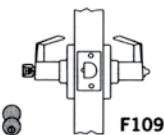
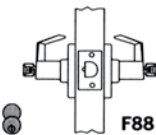
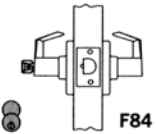
FUNCTION	SERIES	OUTSIDE/INSIDE	DESCRIPTION
Dummy Trim One Side	CL801 CK801		<ul style="list-style-type: none"> Used as pull or matching trim on pairs of doors.
Passage	CL810 CK810	 F75	<ul style="list-style-type: none"> Latch bolt operated by trim from either side at all times.
Patio	CL830 CK830	 F77A	<ul style="list-style-type: none"> Deadlocking latch bolt operated by trim from either side. Outside trim locked by push button or locking device inside. Outside trim unlocked by inside trim. Outside trim unlocked by closing door. Inside trim always unlocked. Do not use in rooms that have no other entrance.
Privacy	CL840 CK840	 F76A	<ul style="list-style-type: none"> Latch bolt operated by trim from either side. Outside trim locked by push button or locking device inside. Outside trim unlocked by emergency release from outside. Outside trim unlocked by inside trim. Outside trim unlocked by closing door. Inside trim always unlocked.
Hospital Privacy	CL844		<ul style="list-style-type: none"> Latch bolt operated by trim from either side. Outside trim locked by push button or locking device inside. Outside trim unlocked by emergency release from outside. Outside trim unlocked by inside trim. Outside trim unlocked by closing door. Inside trim always unlocked.
Entry	CL853 CK853	 F109	<ul style="list-style-type: none"> Deadlocking latch bolt operated by trim from either side, except when outside trim locked by push button inside. Key outside releases push button, unlocking outside trim, except when inside button pushed and turned to keep outside trim locked. Operating inside trim releases push button, unlocking outside trim, except when inside button pushed and turned to keep outside trim locked. Inside button must be turned to unlock outside trim. Inside trim always operates latch bolt.
Apartment	CL860 CK860	 F88	<ul style="list-style-type: none"> Deadlocking latch bolt operated by trim from either side, except when outside trim locked by key from inside. When outside trim locked, latch bolt retracted by key in outside trim. When outside trim locked, latch bolt operated by inside trim.
Classroom	CL870 CK870	 F84	<ul style="list-style-type: none"> Deadlocking latch bolt operated by trim from either side, except when outside trim locked by key from outside. Key in outside trim locks or unlocks outside trim. When outside trim locked, latch bolt operated by inside trim.

 Indicates SFIC Core available.

 Indicates rigid lever.

DOOR LOCKS

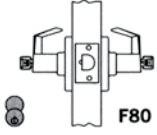
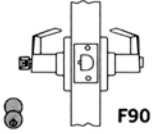
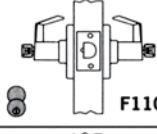
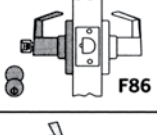
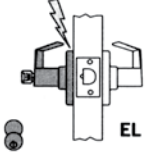
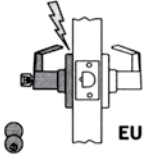
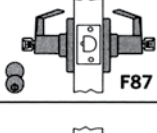
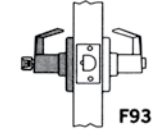
FUNCTION	SERIES	OUTSIDE/INSIDE	DESCRIPTION
Communicating	CL872 CK872	 F80	<ul style="list-style-type: none"> • Deadlocking latch bolt operated by trim from either side. • Turning key in trim locks, or unlocks, its own trim independently. • Do not use on doors in rooms that have no other exit.
Corridor	CL873 CK873	 F90	<ul style="list-style-type: none"> • Deadlocking latch bolt operated by trim from either side except when outside trim locked by key in outside trim. • Deadlocking latch bolt operated by trim from either side except when outside trim locked by push button on inside. • Key in outside trim locks or unlocks outside trim. • Operating inside trim releases push button. • Closing door restores push button placed in a locked position. • Inside trim always operates latch bolt.
Classroom Intruder	CL877	 F110	<ul style="list-style-type: none"> • Deadlocking latch bolt operated by trim from either side, except when outside trim locked by key from either side. • Inside trim always unlocked.
Storeroom	CL880 CK880	 F86	<ul style="list-style-type: none"> • Deadlocking latch bolt retracted by key in outside trim. • Deadlocking latch bolt operated by inside trim. • Outside trim always inoperable.
Electrified Fail Safe	CL880EL CK880EL	 EL	<ul style="list-style-type: none"> • Outside trim locked when power is on. • Outside trim unlocked when power is interrupted. • Inside trim always unlocked.
Electrified Fail Secure	CL880EU CK880EU	 EU	<ul style="list-style-type: none"> • Outside trim unlocked when power is on. • Outside trim locked when power is interrupted. • Inside trim always unlocked.
Asylum	CL882 CK882	 F87	<ul style="list-style-type: none"> • Deadlocking latch bolt retracted by key in trim from either side. • Both trims always rigid.
Hotel	CL885 CK885	 F93	<ul style="list-style-type: none"> • Deadlocking latch bolt operated by inside trim at all times. • Outside trim always inoperable. • Latch bolt retracted by key from outside except when push button, or other locking device, operated, thus shutting out all keys except emergency key. • Operating push button, or other locking device, operates visual indicator outside showing room occupied. • Operating inside trim releases indicator and shut out feature. • Closing door releases indicator and shut out feature.

 Indicates SFIC Core available.

 Indicates rigid lever.

FALCON Falcon
Monarch
Dor-O-Matic

T Series

LOCK FEATURES

Door Thickness: 1-3/8" to to 1-3/4" standard.

Backset: 2-3/4" standard; 2-3/8" also available.

Mechanism: Parts constructed of brass or cold-formed steel, zinc plated and dichromated for rust resistance. Springs are stainless steel.

Handing: Locks are non-handed.

Screws: Furnished with combination screws for use in wood or metal doors and frames.

Strikes: 4-7/8" x 1-1/4" ANSI strike with curved lip to meet ANSI A115. 2 door frame preparation standard.

Attachment: Lock chassis secured to door by threaded mounting nuts. Completely preassembled outer trim and inner spindle assembly are through-bolted over chassis using (2) 10-32 screws. Adding rose and lever to inner spindle assembly completes installation.

Cylinders: Drilled with 6 pin chambers, pinned in 5. Pinning in 6 chambers available when specified, at no cost. 7 pin cylinders also available. Cylinder assemblies removable to rekey. Also available with 6 or 7 pin interchangeable core cylinders. Cylinder housings and plugs machined from solid brass. Springs are phosphor bronze. Two nickel silver keys furnished standard.

Trim: Roses are heavy wrought brass or bronze, installed over pressure cast rose inserts which are through-bolted through door. Levers are pressure cast (solid levers -no inserts) material finished to match mating parts.

Latches: 1/2" bolt projection, UL listed with latch face-plates 2-1/4" x 1-1/8" with square corners standard. 3/4" projection, UL listed latch with 2-3/4" backset also available. Adjustable front standard.

Electrified Functions: Available in 12 or 24 VAC or VDC.

ANSI/BHMA: Meets ANSI/BHMA A156.2, Series 4000, Grade 1.

UL: 3 hour A label.

NEW



**D
DANE**

T Series

Grade 1 Leversets.

UL Listed, 2-3/4" backset,

Dane Lever Design

Keyed functions: Schlage C Keyway, KD

Order #	Item #	Function	Cat. Price
285-2000	T101S 626	Passage	\$162.40
285-2005	T301S 626	Privacy	203.00
285-2010	T511PD6 626	Entry	225.40
285-2015	T561PD6 626	Classroom	225.40
285-2020	T581PD6 626	Storeroom	225.40
285-2040	T411PD6 626	Asylum	265.30
	Schlage C, 0-bitted		

For Small Format Interchangeable Core, less core

Order #	Item #	Function	Cat. Price
285-2025	T511BD 626	Entry	\$225.40
285-2030	T561BD 626	Classroom	225.40
285-2035	T581BD 626	Storeroom	225.40

ANSI A156.2 Series 4000

Key-In-Lever Locks

FALCON ANSI & GRADE

T101



F75-1 Passage/Closet Latchset
Latch bolt by levers at all times.

T291



Privacy Hospital Lock
Latch bolt by levers. Outside lever locked by push button in inside lever. Rotating inside lever, closing door, or turning emergency release turn button on outside, release push button. Inside is always free for egress.

T301



F76-1 Privacy Lock
Latch bolt by levers. Outside lever locked by push button in inside lever. Rotating inside lever or closing door releases push button. Emergency release in outside lever unlocks door.

T351



Closet Lock
Deadlocking latch bolt by turn knob inside or lever outside except when outside lever is locked by key.

T381



F88-1 Classroom Security Lock
Latchbolt operated by lever from either side except when key from inside lever locks outside lever. When outside lever is locked, latchbolt retracted by key in outside lever or by turning inside lever.

T411



F87-1 Asylum Lock
Deadlocking latch bolt operated by key in lever from either side. Both levers always inoperable.

T501



F82-1 Entry Lock
Push button locking. Button on inside locks outside lever until unlocked by key or by rotating inside lever. Inside lever always free. Deadlocking latch bolt.

T511



F109-1 Entry/Office Lock
Turn/push button locking. Pushing and turning button locks outside lever requiring use of key until button is manually unlocked. Push button locking. Pushing button locks outside lever until unlocked by key or by rotating inside lever. Inside lever always free. Deadlocking latch bolt.

Key-In-Lever Locks

FALCON ANSI & GRADE

T521



F81-1 Office Lock
Turn button locking. Turning button locks outside lever requiring use of key until button is manually unlocked. Inside lever always free. Deadlocking latch bolt.

T561



F84-1 Classroom Lock
Deadlocking latch bolt by levers. Outside lever is locked by key in outside lever. Inside lever is always free.

T571



F90-1 Dormitory Lock
Deadlocking latch bolt by levers except when locked by push button in inside lever. Key in outside lever locks or unlocks outside lever and releases button. Closing door releases push button. Inside lever always free.

T581



F86-1 Storeroom Lock
Deadlocking latch bolt by lever inside or key outside. Outside lever is inoperable. Inside lever always free.

T851



Storeroom (Electrified - Fail Safe)
Latch bolt operated by lever from either side except when outer lever is electrically locked. When outer lever is locked (inoperable), latch bolt retracted by key in cylinder outside. 24 volt DC .185 Amps, continuous duty.

T881



Storeroom (Electrified - Fail Secure)
Deadlocking latch bolt operated by lever inside at all times. Outside lever inoperable until electrically unlocked, then latch bolt from either side. When outside lever is inoperable latch bolt retracted by key in cylinder outside. 24 volt DC .185 Amps, continuous duty.

T12



Dummy Trim
Single Trim-surface mounted rigid lever.

FALCON Falcon
Monarch
Dor-O-Matic

W Series

LOCK FEATURES

Door Thickness: 1-3/8" to to 1-3/4" standard.

Backset: 2-3/4" standard; 2-3/8" also available.

Mechanism: Parts constructed of brass or cold-formed steel, zinc plated and dichromated for rust resistance. Springs are stainless steel.

Handing: Locks are non-handed.

Screws: Furnished with combination screws for use in wood or metal doors and frames.

Strikes: 4-7/8" x 1-1/4" ANSI strike with curved lip to meet ANSI A115. 2 door frame preparation standard.

Attachment: Lock chassis secured to door by two screws which pass through a steel rose insert inside and thread directly into the outer rose-mounting assembly, and two screws that screw into the chassis assembly.

Cylinders: Pinning in six chambers. Cylinder assemblies removable to re-key. Also available with 6- or 7-pin interchangeable core cylinders. Cylinder housings and plugs machined from solid brass.

Springs are stainless steel. Two nickel silver keys furnished standard.

Competitor Cylinder: The W Series accepts standard 6-pin cylinders available from Falcon, as well as Schlage, Corbin-Russwin, Yale and Sargent.

Trim: Roses are 3-5/8" diameter, heavy wrought brass or bronze, installed over steel rose inserts which are through-bolted through door. Levers are pressure-cast zinc (solid levers-no-inserts) finished to match mating parts.

Latches: 1/2" bolt projection made of stainless steel and UL listed for 3-hour door assemblies. Latches have self-adjusting fronts to accommodate beveled or flat doors. 2-3/8" backset with 2-1/4" x 1" latch faces or 2-3/4" backset with 2-1/4" x 1-1/8" latch faces.

ANSI/BHMA: Meets ANSI/BHMA A156.2, Series 4000, Grade 2.

UL: 3 hour A label.



W Series

Grade 2 Leversets.

UL Listed, 2-3/4" backset,

Dane Lever Design

Keyed functions: Schlage C Keyway, KD

Order #	Item #	Function	Cat. Price
285-3000	W101S 626	Passage	\$59.52
285-3005	W101S 605	Passage	68.20
285-3010	W101S 613	Passage	68.20
285-3015	W301S 626	Privacy	60.76
285-3020	W301S 605	Privacy	69.44
285-3025	W301S 613	Privacy	69.44
285-3030	W511PD 626 CP6	Entry	65.72
285-3035	W511PD 605 CP6	Entry	74.40
285-3040	W511PD 613 CP6	Entry	74.40
285-3045	W561PD 626 CP6	Classroom	65.72
285-3050	W581PD 626 CP6	Storeroom	65.72

For Small Format Interchangeable Core, less core

285-3055	W511BD 626	Entry	\$65.72
285-3060	W561BD 626	Classroom	65.72
285-3065	W581BD 626	Storeroom	65.72

2-3/8" Latches for Falcon W Series

Order #	Item #	Function	Cat Price
285-3070	Q330-209 626	Springlatch	\$12.76
285-3080	Q330-203 626	Deadlatch	12.76

W-Series • Lever Functions



ANSI A156.2, Series 4000

Key-In-Lever Locks

FALCON

ANSI
FUNCTION

W101

F75-1 Passage Latchset
Latch bolt by levers at all times.



W161

Communicating/Exit Latch
Deadlocking latch bolt by inside lever.
Non-removable blank plate outside.
Inside lever is always free.



W201

F77 Patio Lock
Deadlocking latch bolt by levers.
Outside lever is locked by push button
from inside. Rotating inside lever or
closing door releases button and
unlocks outside lever.



W301

F76 Privacy Lock
Latch bolt by levers. Outside lever is
locked by push button in inside lever.
Rotating inside lever or closing door
release push button and frees outside
lever. Inside lever is always free.
Emergency release in outside lever
unlocks door.



W501

F82-2 Entry Lock
Push button locking. Button on inside
locks outside lever until unlocked by
key or by rotating inside lever. Closing
door release push button and unlocks
door. Inside lever always free.
Deadlock latchbolt.



W511

F109 Entry/Office Lock
Deadlocking latch bolt by levers.
Turn/push button locking. Pushing
and turning button locks outside lever,
requiring use of a key for unlocking the
door until button is manually unlocked.
Pushing button locks outside lever until
unlocked by key or by rotating inside
lever. Inside lever is always free.



Key-In-Lever Locks

FALCON

ANSI &
FUNCTION

W561

F84 Classroom Lock
Deadlocking latch bolt by levers.
Outside lever is locked by key in
outside lever. Inside lever is
always free.



W581

F86 Storeroom Lock
Deadlocking latch bolt by lever inside
or key outside. Outside lever is always
locked. Inside lever is always free.



W711

Apartment Entrance Lock
Deadlocking latch bolt by levers.
Turn/push button locking. Pushing and
turning button locks outside lever,
requiring use of a key for unlocking the
door until button is manually unlocked.
Pushing button locks outside lever until
unlocked by key, by rotating inside
lever, or by closing door.
Inside lever is always free.



W12

Dummy Trim
Single Trim-surface mounted rigid
lever.



FALCON Falcon Monarch Dor-O-Matic



Falcon M Series Mortise Lock

Grade 1, ANSI/BHMA A156.13, Series 1000.

UL Listed (3 hour A Label).

Case made of cold rolled formed steel, .090" thick. All steel interior parts and case double treated with zinc plating an chromate conversion coating to resist rust. Hardened steel hubs.

1" projection deadbolt, with two hardened steel rollers. Latch bolts are 3/4" projection, two piece metal anti-friction type.

Door thickness: 1-3/4" to 2-1/4".



Handing: Standard right, field reversible.

Faceplates: Armored Front, 1-1/4" x 8" brass, bronze, and stainless steel adjustable for door bevel. Reinforced by heavy gauge steel with stabilizing ribs.

Strike. Meets ANSI A115.1 for frame preparation. Strike is handed.

Backset: 2-3/4", **7-Pin IC, LESS CORE:**

FUNCTIONS:

M561		Classroom Lock. Deadlocking latch bolt by knobs/levers. Outside knob/lever locked by key outside. Inside knob/lever always free.
M571		Dormitory Lock. Latch bolt by knobs/levers except when outside knob/lever is locked by projecting dead bolt. Key outside retracts dead bolt and unlocks outside knob/lever. Rotating inside knob/lever retracts both bolts.
M581		Storeroom Lock/Exit Lock. Deadlocking latch bolt by inside knob/lever or key outside. Outside knob/lever rigid.

Other FALCON functions and locks are available by special order.

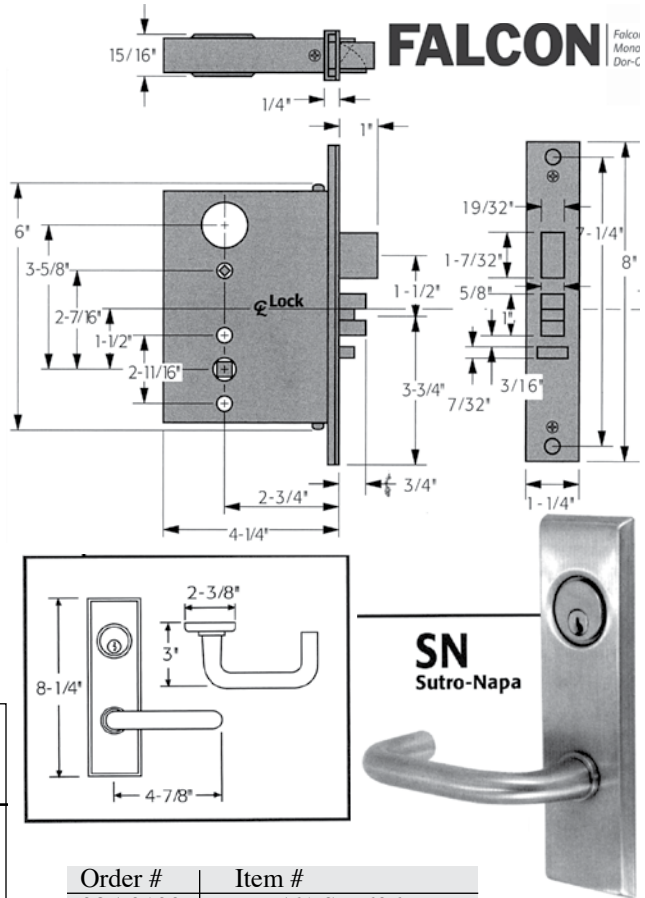

Order #	Item #
285-0100	LM561 SN 626 RH
285-0105	LM561 SN 626 LH
285-0090	LM571 SN 626 RH
285-0095	LM571 SN 626 LH
285-0110	LM581 SN 626 RH
285-0115	LM581 SN 626 LH

Catalog Price: **\$529.36**

FALCON

DEADBOLT Interchangeable Core.

Furnished without a core.

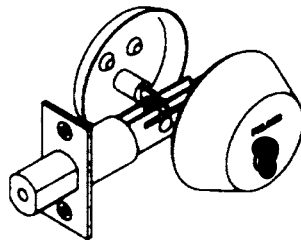

STANDARD DUTY

Cylinder	Item#	Order # 2-3/8"	Order # 2-3/4"	Price
Single	D840-26D	285-1007	285-1008	\$75.92
Double	D830-26D	285-1005	285-1006	98.80

HEAVY DUTY

Single	D440-26D	285-1003	285-1004	\$97.76
Double	D430-26D		285-1002	124.80

FALCON Latches



X Series

Order #	Falcon #	Backset	Series	Price
285-0039	A98535-00D 606	2-3/4	X	\$66.30
285-0040	A98535-00D 630	2-3/4	X	70.36
285-0044	(U) A94435-00D 630	2-3/4	S	41.86

We are an authorized FALCON Dealer, if you don't see what you are looking for, give us a call!

FALCON ENTRY LEVER LOCKS

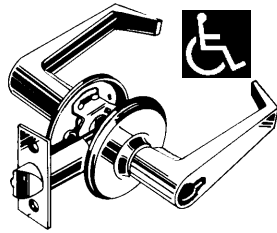

Outside knob, rose and chassis one single assembly. Inner mechanism secured to the door with two through-bolt screws through a steel mounting plate. Snap on inner rose conceals screw heads.

Door Thickness: 1-3/8" to 1-3/4".
Backset: 2-3/4" standard. 2-1/4" x 1-1/8" latchface.
Strike: 2-3/4" x 1-1/8" standard with curved lip to meet ANSI A115.2 standard door frame preparation.
Handing: Field reversible.
Certification: ANSI A156.2, Series 4000, Grade 2. Complies with Title 19, California State Fire Marshall and all state handicap codes.

"Y" Series Lever Locks

Order #	Item #	Description	Price
285-0085	Y521-BD-US26D-I.C.	Less Core	\$162.24

Falcon Grade 2, Standard Duty Tubular Lockset



ANSI-A126.2, Series 4000, Grade 2
 Interchangeable Core Entry Lock, **LESS CORE**

Order #	Item #	Catalog Price
285-0080	Y521BD HANA 626	\$84.24

INTERCHANGEABLE CORE Locks X, S, & Y Series IC Core Locks Cylinders Not Included. Entry Function

Order #	Item #	Backset	Cat. Price
285-0060	X511B TG 626 IC	2-3/4	\$353.60
285-0065	S511DLTG 26D IC	2-3/4	127.92
285-1009	Y521E 26D IC	Adj	84.24
285-1010	Y521E 26D IC	2-3/4	84.24

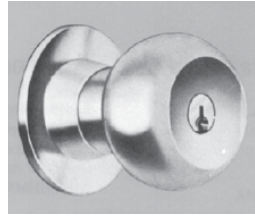

Troy-Gala TG Grade 1

"X" Series Knob Locks

Heavy duty (meet or exceed Federal Spec. FF-H-00106B. Approved for VA and US Army Corps of Engineers. 2-3/4" Backset. Less Cylinder. 5164 ASA Strike

Order #	Item #	Function	Catalog Price
285-0050	X511LD TG 26D	Entry	\$353.60



FALCON T-Series Key-in-lever cylindrical lockset



ANSI/BHMA A156.2, Series 4000, Grade 1.
 UL Listed (3 Hour A Label)
 Pressure Release feature. When outside lever is locked, it is not rigid but will move freely without operating the latch bolt.
 Non-handed
 Door thickness from 1-3/4" to 2-1/8"
 2-3/4" Backset
 7-Pin IC prep small format, LESS CORE
T561 Classroom Lock. Deadlocking latch bolt by levers. Outside lever is locked by key in outside lever. Inside lever is always free. **T581** Storeroom Lock.

Order #	Item #	Catalog Price
285-0070	T561B x DANE x 26D	\$334.88
285-0035	T581B x DANE x 626	289.80

Falcon Storeroom, "G" Keyway

285-0030	T581PD x DANE x 626	289.80
----------	---------------------	--------

Falcon Classroom Security Lock, Less Core

Order #	Item #	Catalog Price
285-0075	T381-B-DANE-IC-7Pin-626	\$394.16

FALCON RU SERIES

Retrofit Locks Features and Benefits

The RU Series from Falcon is designed to retrofit existing unit locks manufactured by Falcon (Weiser), Corbin Russwin and Yale. It exceeds ANSI Grade 1 specifications and is UL/ULC listed. Incorporates Falcon's vandal resistant PressureRelease™ trim to prevent damage to internal mechanism. Installs with minimal rework to existing doors while preserving door and frame for cost effective project planning. Falcon's RU Series satisfies all ADA easy access requirements.

Features Include:

- Vandal resistant PressureRelease™ outside lever disengages when locked to prevent damage to internal mechanism.
- "Power Spring™" in rose trim prevents lever sag.
- No exposed mounting screws.
- Solid bar stock deadlocking feature prevents latch binding and lock failure due to poor door alignment.
- Exceeds 800,000 cycle ANSI Grade 1 requirement.
- Meets or exceeds all other ANSI A156.2 rigorous Grade 1 specifications for key-in-lever products.

Benefits Include:

- Preserves existing facility doors and frames.
- Preserves original architectural design without adapter plate or add-ons.
- Easy installation with minimal door modifications.
- Features a 4" square rose which covers existing mounting holes, most paint lines and required door rework.
- Complies with ADA easy access requirements.
- UL/ULC listed for 3 Hour A Label doors.
- Strikes available to match existing frame preparation.
- Reuse existing facility cylinders and key system.
- Non-handed chassis and field reversible trim and latch bolt for easy stocking and lower inventory cost.
- Key removable outside lever for easy cylinder replacement.

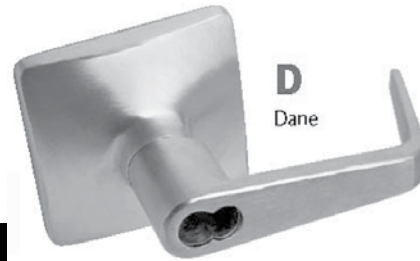

- Outside lever secured by a spring-loaded retainer. Retainer cannot be depressed when locks have been locked. Inside lever secured by a set screw. Levers have heavy-duty steel individual return springs in order to prevent lever sag.

Falcon Lock RU Series Specifications

- Exceeds ANSI A156.2 Grade 1 Key-in-Lever specifications.
- Interchangeable core levers are non-removable with core installed.
- Accepts interchangeable (removable) cores (Not Included).
- PressureRelease™ (clutchable) outside lever.
- Heavy duty, solid levers are 5" long and have no inserts.
- No exposed mounting screws.
- Installs with 10-32 through-bolt screws with thread sealant for extra security and resistance to vibrating loose.
- Standard lock is for 1-3/4" thick doors. Also available for 2" and 2-1/4" thick doors.
- 2-3/4" backset only.
- ANSI strike standard.

Classroom Lever: Deadlocking latch bolt by levers.

Outside lever is locked by key in outside lever.
Inside lever is always free.

LESS SFIC. 1-3/4" Latch Height (#31469P),
ANSI strike (#5164)

Order #	Item #	Catalog Price
285-0120	RU561BD-Dane-626	\$600.08

ESP

Amarlock Replacement Lock for Narrow Style Doors.

Takes a 1-3/16" diameter cylinder. Has a unique telescoping bolt-in-a-bolt, for a total throw of 1-1/4". 7/8" Backset. Case Size: 1-1/8 x 1-1/2 x 2-15/16"

- **Bolt:** Housing section is 1/2 x 3/4 x 1".
- **Steel extension** is 11/32 x 19/32 x 7/8" cast steel.
- **Face:** 1 x 5" with 4-1/2" CC oval screw holes.

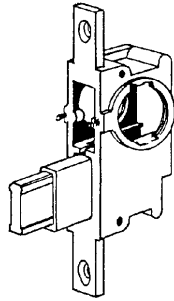

Cylinder not included.

350-0077 | ODDAL-77 | Catalog Price: **\$38.24**

KABA ILCO

Jimmy Proof Rim Locks

530-53-41

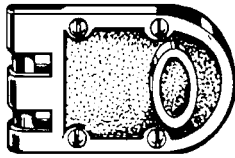

535-53-55

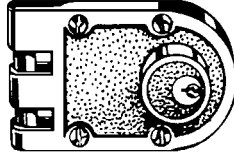

2-1/2" Backset, 1-1/4" Crossbore. Door thickness: 1-1/4" to 2-1/4".

SINGLE CYLINDER:

Order #	Item #	Strike	Cylinder	Keyway	Price
400-2091	530-53-41	Angle	Die Cast	1004	25.80

DOUBLE CYLINDER:

400-2094	535-53-55	Angle	Die Cast	1004	31.50
----------	-----------	-------	----------	------	--------------

Ilco Night Latches.

Economical night latch operates by key outside, turn knob inside. Bolt may be held back by turn knob inside. Handsome Bronze Lacquer finish blends with any decor.

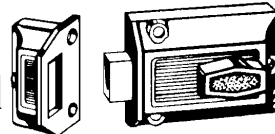
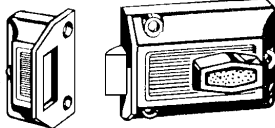

400-2086 | 220-53-41 | **\$18.00**

Rim Deadlocks.

Rim deadlock replaces most night latches with additional drilling or mortising required. Operates by key outside, turn knob inside. Two strikes furnished for door opening in or out. Bolt extends 3/4". Painted brass finish.

400-2096 | 545-54-41 | **\$18.00**

GLYNN JOHNSON Hospital Latches

Push/Pull Latches

Originally designed for hospital safety and convenience, the HL6 can also be used in schools, nursing homes and other locations requiring label door construction where easy access is desirable. Also can be used in handicapped person areas. Non-handed.

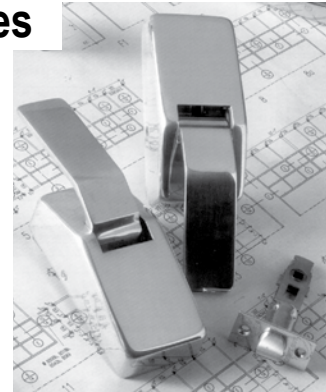

- **For Doors:** 1-3/4 to 2-1/4"

- **Escutcheons:** 2-9/16" x 4-1/2"

- **Bolt:** 1/2" throw

- **Backset:** 2-3/4 or 5"

- **Levers:** 1-1/2 x 4-1/2

- **Projection /door:** 2-1/2 min., 2-5/8" max.

- **Door Prep:** Government 161 cutout

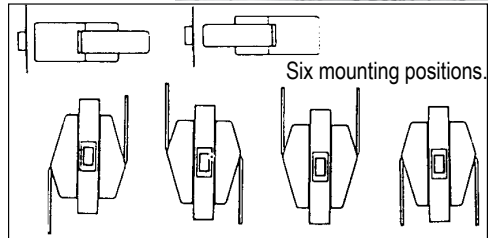

Order #	Item #	Backset	Price
330-0006	HL6-US26D	2-3/4"	\$341.80
330-0010	HL6-US26D	5"	341.80

KABA ILCO

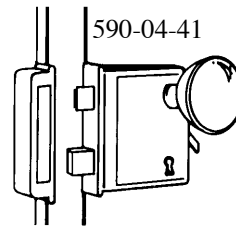

Rim Locksets, Upright Style

Surface mounted, not mortising. Reversible bolt. Lever on lock case deadlocks knobs. Includes threaded spindle, two metal knobs, one deep drawn rosette and key escutcheon.

865-7300 | 590-04-41 | **\$25.36**

Inside Lockset

Perfect for most inexpensive installations, ideal for replacements. Lock has rust proof case, one tumbler construction. Set includes two broad bevel plates featuring snug knob fit and a threaded spindle operating two heavy metal knobs.

865-7100 | 215-04-51 | **\$25.36**



SIMPLEX Pushbutton Locks



4" x 5", Weight 4 lbs
 04: Satin Brass
 26D: Brushed Chrome

1. Spring Latch with Deadlatching trigger & latch hold back feature.
2. Spring Latch with Key Bypass Cyl. & one service key.
3. Special Spring Latch to meet DOD standards for restricted areas.

100 Series for 1-3/8 to 1-1/2" thick doors.
 200 Series for 1-3/4 to 2-1/8" thick doors.

Order #	Item #	Series	Function	Key Bypass	Price
825-0902	9020000-04-41	100	Deadbolt	No	176.80
825-0903	9020000-26D-41	100	Deadbolt	No	176.80
825-0904	9040000-04-41	200	Deadbolt	No	176.80
825-0905	9040000-26D-41	200	Deadbolt	No	176.80
825-0916	9170000-04-41	100	Springlatch ¹	No	209.30
825-0917	9170000-26D-41	100	Springlatch ¹	No	209.30
825-0918	9190000-04-41	200	Springlatch ¹	No	209.30
825-0919	9190000-26D-41	200	Springlatch ¹	No	209.30
825-0935	9350000-26D-41	100	Springlatch ²	Yes	283.40
825-0938	9380000-04-41	200	Springlatch ²	Yes	283.40
825-0939	9380000-26D-41	200	Springlatch ²	Yes	283.40
825-0929	9290000-26D-41	200	DOD Springlatch ³	No	325.00

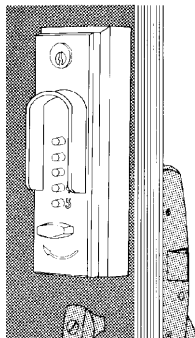

See
 "Repair Parts"
 (Section 14)
 for a
 complete line of
 Simplex parts.

2000-15

UNICAN Series 2000

Works With Most Exit Devices

Completely mechanical and weather resistant. Equipped with a 2-3/4" long adjustable connecting bar (tailpiece) to operate surface mounted panic devices from outside. Operates with devices that open with a maximum 90 degree clockwise rotation of the panic device hub, includes many popular models. *Should not be used with thumb operated devices, mortise design or vertical rod units.* Any standard pull can be mounted adjacent to the 2000-15 to pull door open. Can be dogged open without effecting the unit.

825-2015	SIM-2015-26D-41	\$420.00
----------	-----------------	----------



NOTE: Exit Device and Interchangeable Cores are not provided.

LP1000

- Meets or exceeds American with Disabilities Act as well as other handicapped and fire codes.
- One hand operation: Just punch in the combination and depress the lever.

LP1020 Works With Most Exit Devices

This fully mechanical pushbutton combination door lock can be mated with most manufacturers rim mounted exit devices. Replaces the key cylinder on new or existing surface mounted exit devices. Rugged, weather resistant mechanical. Perfect for outdoor applications. Designed for high frequency use. Eliminates problems associated with issuing and controlling keys or magnetic cards. A quick and simple cost free combination change (without removing lock from door assures maximum security after employees, tenants or guests leave.

Key Bypass Outside Lever

Uses Arrow-Best-Eagle-Falcon IC Cores:

Order #	Item #	Price
825-0125	LRP1020B-26D-41 RH	\$748.80
825-0130	LLP1020B-26D-41 LH	732.00

Uses Schlage IC Cores:

825-0135	LRP1020S-26D-41 RH	\$732.00
825-0140	LLP1020S-26D-41 LH	732.00

DOOR LOCKS

Access Control with Knob Operation

1000 Series Standard Knob Access Control

Fits Door 1-3/8" to 2-1/4" thick.
Access by combination. 2-3/4" Backset

825-1000	SIM 1011-026-41	\$513.60
825-1001	SIM 1011-26D-41	489.60
825-0165	SIM 1011-03-41	513.60
825-1003	SIM 1011-5B-41	489.60

KNOBS WITH KEY BYPASS

Capability In Outside.
KNOB: Uses IC Cylinders. NOT INCLUDED.
Fits Door 1-3/8" to 2-1/4" thick.
Access by combination or key bypass.

Order #	Item #	Cylinder	Price
825-1002	1021B-26D-41	Falcon/Best	\$573.60
825-1008	1021B-026-41	Falcon/Best	597.60
825-1004	1021B-5B-41	Falcon/Best	573.60
825-1005	1021C-26D-41	Corbin	573.60
825-0005	1021S-26D-41	Schlage	573.60
825-1009	1021S-026-41	Schlage	597.60
825-0170	1021S-03-41	Schlage	597.60
825-0010	1021S-5B-41	Schlage	573.60
825-0006	1021M-26D-41	Medeco	573.60

1000 Series Standard Latch

5/8" throw standard latch carries 3-hour UL/ULC fire rating for "A" labeled doors - 2-3/4" backset floating front. This is the latch now furnished with the locks.



Order #	Item #	Cat. Price
825-2040	201961-05-01	\$78.40
825-2041	201961-26D-01	78.40

L1000 Series Latch. 1/2" Throw.
2-3/4" Backset & UL Listed. Beveled Front.

Order #	Item #	Cat. Price
825-8000	204168-26D-01	\$43.40
825-8001	204168-03-01	43.40

3/4" Beveled Latch, 2-3/4" Backset for 1000 Series.

825-4385	210144-AB	Antique Brass	\$74.20
----------	-----------	---------------	----------------



PUSHBUTTON LOCKS



1000 Series: FINISHES:
(026) Bright Chrome
(05) Antique Brass
(26D) Brushed Chrome
(03) Bright Brass

Dimensions: 3" Wide,
7-3/8" High, 3-13/16" Deep.

SIMPLEX Pushbutton Locks

Heavy Duty Primary Lockset EE1000 Series

The entry-egress lock is for situations where access control is required on both sides of the door. A different code may be programmed on each side for added security.

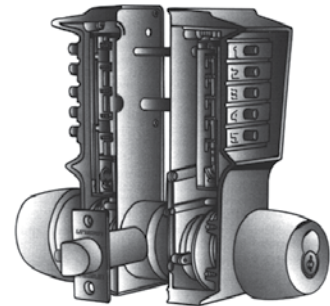

Description:

Exterior access by combination. Interior egress by combination.

Specifications:

- Conforms to ANSI 156.2 Grade 1.
- 1-3/8" to 2" Door Thickness
- 5" Minimum Stile for mounting
- 2-3/4" Backset, 5/8" Throw
- Weight: 10.25 lbs

Order #	Item #	Catalog Price
825-0220	EE 1011-26D-41	\$1080.00

Access Control with Lever Operation



L1000 Series lever operated locksets

Provide fully mechanical, pushbutton combination access control for security sensitive, high traffic areas. One hand operation. Conforms to handicapped and fire codes. 1/2" throw deadlatch, 2-3/4" Backset.

STANDARD

Pushbutton Locks with Lever Handles

(RH, Right Hand or LH, Left Hand):

Order #	Item #	Handing	Price
825-0015	LR1011-26D-41	RH	\$588.00
825-0020	LL1011-26D-41	LH	588.00
825-0016	LR1011-026-41	RH	612.00
825-0021	LL1011-026-41	LH	612.00
825-0175	LL1011-03-41	LH	612.00
825-0180	LR1011-03-41	RH	612.00
825-0025	LR1011-05-41	RH	588.00
825-0030	LL1011-05-41	LH	588.00



1021 Series KEY BYPASS: Pushbutton Locks with Lever Handles Uses FALCON/BEST

Removable Core Cylinders (Cylinders Not Included).

825-0035	LR1021B-26D-41	RH	\$672.00
825-0040	LL1021B-26D-41	LH	672.00
825-0195	LL1021B-03-41	LH	696.00
825-0200	LR1021B-03-41	RH	696.00
825-0045	LR1021B-05-41	RH	672.00
825-0050	LL1021B-05-41	LH	672.00
825-0036	LR-1021B-026-41	RH	696.00
825-0041	LL-1021B-026-41	LH	696.00

Uses SCHLAGE

Removable Core Cylinders (Cylinders Not Included).

825-0055	LR1021S-26D-41	RH	\$672.00
825-0060	LL1021S-26D-41	LH	672.00
825-0185	LL1021S-03-41	LH	696.00
825-0190	LR1021S-03-41	RH	696.00
825-0065	LR1021S-05-41	RH	672.00
825-0070	LL1021S-05-41	LH	672.00
825-0056	LR-1021S-026-41	RH	696.00
825-0061	LL-1021S-026-41	LH	696.00





**1021 Series KEY BYPASS:
Pushbutton Locks
with Lever Handles**

Uses Corbin/Russwin

Removeable Core Cylinders (Not Included)

825-0080	LL1021C-05-41	LH	\$672.00
825-0085	LR1021C-05-41	RH	672.00
825-0090	LL1021C-26D-41	LH	672.00
825-0100	LR1021C-26D-41	RH	672.00

Uses Medeco

Removeable Core Cylinders, Not Included

825-0105	LL1021M-05-41	LH	672.00
825-0110	LR1021M-05-41	RH	672.00
825-0115	LL1021M-26D-41	LH	672.00
825-0120	LR1021M-26D-41	RH	672.00

Uses Sargent

Removeable Core Cylinders, Not Included

825-0145	LL1021R-26D-41	LH	672.00
825-0150	LR1021R-26D-41	RH	672.00

**For Simplex Parts, please turn to Section 14:
REPAIR PARTS.**

**1041 Series Key-Bypass
Lever Operated Locksets**

SIMPLEX Pushbutton Locks



L1041 Series

Uses Best

Removeable Core Cylinders, Not Included.

L1041. Exterior access by combination, key override, or passage feature. Interior has passage feature (Thumbturn & Key Egress by interior lever.)

825-0155	LL1041B-26D-41	LH	732.00
825-0160	LR1041B-26D-41	RH	732.00

Uses Schlage

Removeable Core Cylinders, Not Included.

Pushbutton leverset, exterior access by combination, key override. Interior has passage feature.

825-0205	LL1041S-26D-41	LH	732.00
825-0210	LR1041S-26D-41	RH	732.00

Kaba-Ilco

L1041 Series



Uses MEDECO

Removeable Core Cylinders, Not Included.

L1041. Exterior access by combination, key override, or passage feature. Interior has passage feature (Thumbturn & Key Egress by interior lever.)

Order #	Item #	Handing	Cat. Price
825-0156	LL1041M-26D-41	LH	732.00
825-0161	LR-1041M-26D-41	RH	732.00

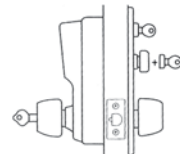

**Simplex Pushbutton
Cylindrical Lockwith Knob.**

Combination entry with Key Override and Passage. SFIC, Less Cylinder.

Order #	Item #	Catalog Price
825-1041	1041B-26D-41	\$621.60

SIMPLEX Pushbutton Locks

3000 Series Narrow Stile

The 3000 Series lock provides fully mechanical pushbutton access control for narrow stile aluminium doors, with no electrical wiring, electronics, or batteries. Exterior access is by combination or key override. Egress is by Adams Rite hardware and is free at all times.



The 3000 Series lock is designed for use with Adams Rite 4510/4710 latch mechanisms and most Adams Rite egress hardware. Any standard mortice cylinder that operates the Adams Rite latch will function with a 3000 Series lock. Key cylinders, cylinder trim rings, mortise latches, and egress hardware are not provided.

3000 Series locks are ideal for limiting access to high traffic, security sensitive areas in commercial, institutional, government and industrial buildings. These locks are perfect for locations with a high personnel turnover rate such as data processing centres, employee entrances, R&D labs, apartments, dormitories and restricted areas in hospitals and airports.

The pushbutton design eliminates problems associated with the issue, control, and collection of keys and magnetic cards. The combination can be quickly and easily changed to ensure continued security once employees, tenants, or guests leave, saving the cost of new keys, cylinders, magnetic cards and card encoding devices. The combination is changed without . . .

Features

- Designed for Narrow Stile Aluminium Doors
- In or Out Swing doors
- Uses Adams Rite 4510/4710 Mortice Lock
- Uses Standard Adams Rite Exit Hardware
- Key Override, Lockout and Passage Features
- Stile minimum 48mm (1-3/4") Required
- Stile maximum thickness 44mm (1-3/4")
- Backset 28mm
- Requires Factory Handed Drive Mechanism
- Satin Chrome Finish
- Simple On Door Code Change

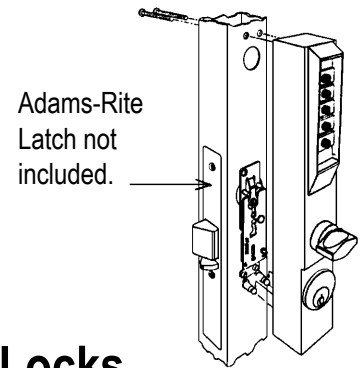

**SERIES 3000
Narrow Stile Locks**

For a complete installation, you must include a Combination Lock Housing AND a Drive Assembly.

Lock Body Height: 9-5/8". Width: 1-17/32". Depth: 2-5/8". Housing & Drive Assy. weigh approx. 4 lbs.

Managements' **Exclusive Key**: Overrides any code. Locks out use of combination after hours. Keeps lock open in retracted position.

DRIVE ASSEMBLIES \$75.60 each

Order #	Item #	Backset	Handing
825-3010	3010-19-41	31/32	RH or RHRB
825-3020	3020-19-41	31/32	LH or LHRB
825-3030	3030-19-41	1-1/8	RH or RHRB
825-3040	3040-19-41	1-1/8	LH or LHRB

Diagram is from outside looking in.

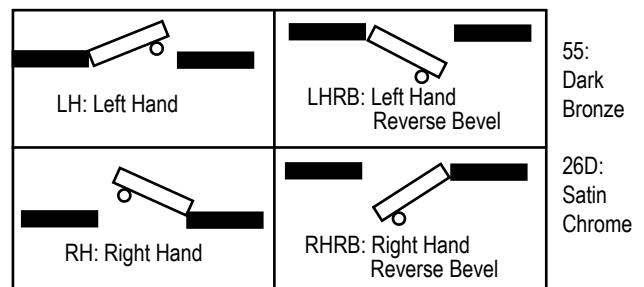

LOCK HOUSINGS

Standard Combination Lock Housing:

825-3001	3001-55-41	\$288.00
825-3000	3001-26D-41	288.00

Combination Lock Housing with Cylinder Guard:

825-3002	3002-55-41	\$307.20
825-3003	3002-26D-41	307.00

SIMPLEX Pushbutton Locks

SIMPLEX
5 0 0 0

Simple, Secure Access Control
for Almost Any Application

The Simplex 5000 lock provides fully mechanical pushbutton access control without any wiring, electronics, or batteries. Exterior access is by combination. Egress is by interior lever and is free at all times. Lock is ADA compliant.

Ideal for controlling access to high-traffic, security-sensitive areas in commercial, industrial, educational, governmental, lodging, and multi-unit residential settings. Perfect for locations with a high user turnover rate such as data processing centers, employee entrances, R & D labs, apartments, dormitories, and restricted areas in hospitals and airports.

Features

- Mechanical pushbutton strength and reliability.
- Keyless convenience. Eliminates problems and costs associated with issuing, controlling and collecting keys and magnetic cards.
- Combination can be quickly and easily changed to ensure continued maximum security once employees, tenants, or guests leave.
- Thousands of possible combinations.
- Easy to install: Installs easily on wood or metal doors. No electrical wiring or computers required for programming. Fully contained front and rear housing assemblies install in minutes.
- Non-handed.
- Easy to maintain: No batteries, and fewer parts to maintain during life of lock.
- User friendly: One-hand operation.
- Mechanical key override: Used to override the lock combination and gain access using a key. Permits facilities to initiate or maintain their master-keyed security system.
- Direct drive: Eliminates potential breakage in critical internal links.
- Rugged and weather-resistant: Lock is wear tested for intensive use.
- Two-year manufacturer's warranty.

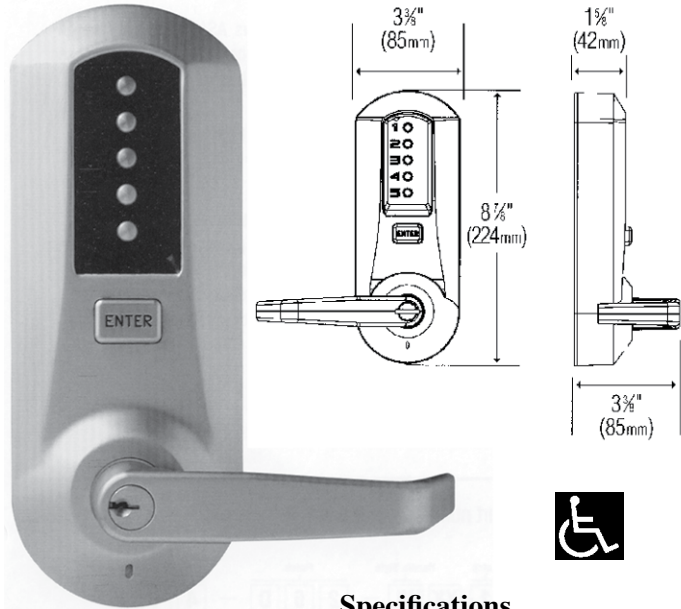

Specifications

Construction: Extra heavy duty cylindrical lock housing; solid cast housings; solid cast zinc levers, stainless steel cylindrical drive components.

Certifications: ANSI/BHMA A 156.2, Grade 1 Certified

Compliance: Three hour U.L./U.L.C. Fire Door Rating
ADA (Americans with Disabilities Act)

Key Override: Convention key-in-lever cylinder with Kaba Ilco #90 Loricentric Cylinder (Key blank: 505-0080), keyed different. Tailpieces included for compatibility with the following cylinders:

Abloy 5277	Abloy 5477	Arrow C 100
ASSA 65611	ASSA 65691	Australian
Corbin Russwin 2000-03	Kaba Ilco 1599	Kaba Ilco 15395
Marks	Medeco 20W200H1	Sargent 10 Line
Schlage 23-001	Schlage Primus 20-760	

Strike: ASA strike plate; **Backset:** 2-3/4" (70mm)

Door Thickness: 1-3/8" (35mm) to 2-1/4" (57mm). Preassembled to accommodate doors 1-5/8" to 2" (41 to 51mm)

Installation: Easily installs on wood or metal doors. ASA 161 door prep with two additional through bore holes. Retrofits cylindrical and tubular locksets with a 2-3/4" backset.

Door Handing: Non-handed, preassembled for left-hand door installations - can be easily changed in the field

Weight: 8.0 lb (3.65 Kg)

Also available for **BEST Interchangeable Core (IC)**

Order #	Item #	Price
825-5020	5021-XKWL-26D-41	\$576.00
825-5030	5021-BWL-26D-41 IC	576.00



Residential Series 6000

Mechanical Pushbutton Combination Door Lock

Five button model provides the same security and access convenience as the heavy duty models, but less expensive. Easy, One hand operation; Relocks automatically. Pickproof Weather resistant; Easy installation; Field reversible; 1000's of combinations; Sturdy heavy duty construction. Quick cost free combination change, "Do it yourself" in less than a minute without removing lock from door. Should "force-proof" thumb turn be forced for any reason, a spring clutch mechanism allows it to slip through 180° without damage to any of lock components. Once correct code is entered, thumb turn operates from new position in normal way.

Doors 1-3/8" to 2-1/8" thick.
H: 5-3/4 x W: 2-3/4 x D: 2-9/16".

Standard Duty 2-3/8" backset:

Order #	Simplex #	Finish	Cat. Price
825-6003	6218-60-41	Gold	\$217.00
825-6059	6218-86-41	Gray	217.00
825-6097	6218-85-41	Black	217.00

SIMPLEX Pushbutton Locks



SIMPLEX Pushbutton Locks

7000 Series

Compact, stylish, and secure. The 7000 Series provides convenient auxiliary lock protection for residential and commercial applications. Mounts above existing lockset or can be used alone.

Models 7002, 7008

- 1" (25mm) Tubular Deadbolt.
- Includes "380" TS strike
- Saw resistant hardened steel insert.
- Must be manually relocked.
- Ideal for front and rear residential/commercial doors, garden cabanas, storage rooms, etc.
- **Model 7002: 2-3/4" • 7008: 2-3/8" Backset**

Model 7004.

- 1/2" (13mm) Deadlocking Latch
- Automatically relocks each time door closes.
- Perfect for storage areas, offices, washrooms, etc.
- 2-3/4" (70mm) Backset • Includes "US" Strike

Specifications

Construction: Cast front housing; all-metal construction with fixed turn knob.

Door Thickness: 1-3/8" to 2-1/4"

Installation: Cross bore for housing:

1-5/8" (41mm) dia. Through bore for latch.

Control: Use standard phillips head screwdriver for combination change.

Field Reversible **Weight:** 2.5 lbs. (1.1 kg)

1/2" Deadlocking:

Order #	Item #	Backset	Finish	Price
825-7000	7014-03-41	Adj.	Bright Brass	\$202.12
825-7005	7014-26D-41	Adj.	Satin Chrome	171.12

1" Dead Bolt

825-7010	7002-03-41	2 ³ / ₄	Bright Brass	\$202.12
825-7015	7002-26D-41	2 ³ / ₄	Satin Chrome	171.12
825-7025	7008-GV-41	2 ³ / ₈	Gold Vein	171.12
825-7020	7008-AC-41	2 ³ / ₈	Antique Copper	171.12
825-7030	7008-SV-41	2 ³ / ₈	Silver Vein	171.12
825-7035	7008-AW-41	2 ³ / ₈	Antique White	171.12
825-7040	7008-03-41	2 ³ / ₈	Bright Brass	202.12
825-7045	7008-26D-41	2 ³ / ₈	Satin Chrome	171.12

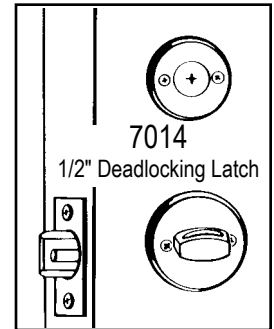
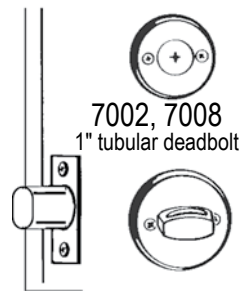
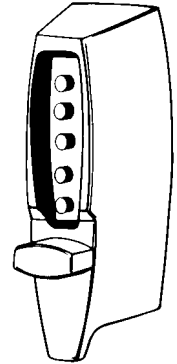

Clutch protected turn knob cannot be forced.



8100 Series Heavy -Duty Mortise Locksets Now with a Deadbolt

The new 8100 Series Pushbutton Lock from Ilco Unican provides the durability and dependability of a mechanical pushbutton lock with the added security of a mortise deadbolt.

Completely mechanical with a heavy-duty, American steel-case mortise lock, it is designed to allow keyless entry for high-traffic areas in commercial, insitutional, and government buildings.

Thousands of possible code combinations virtually eliminate guessing, and the access code is easily changed without removing the lock from the door.

Features:

- Standard door prep.
- ISO 9000-certified manufacturer

Specifications:

- Housing conforms to ANSI/BHMA 156.13
- Dimensions: Front housing, 7-3/8" L x 3-1/8" W x 3-13/16" D (187mm x 79mm x 97mm)
- Door Thickness: 1-1/2" to 2-1/4" (38mm to 57mm)

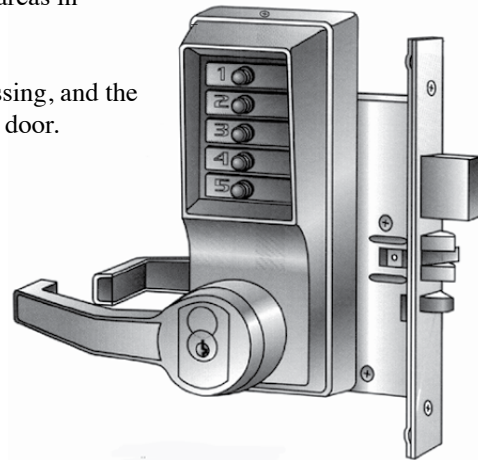
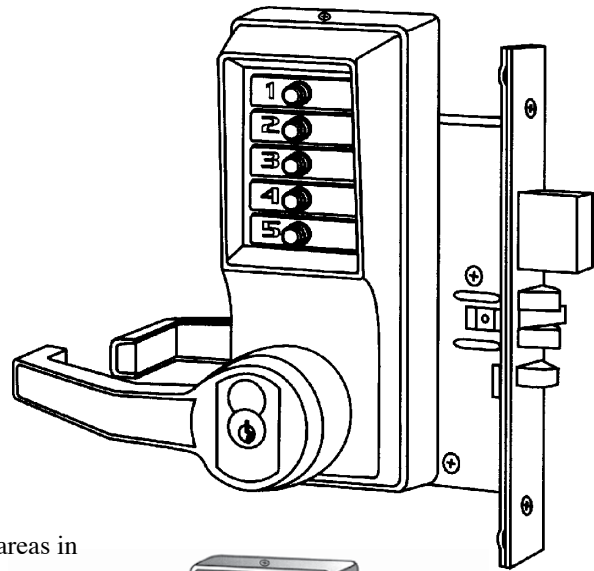

Unican Lever, Heavy Duty Mortise Lock with Key Bypass.

Handed. Cylinder not included.

- Minimum stile required:
5" (127mm)
- Interchangeable Core
(not supplied)
- Factory handed;
NOT field reversible
- Weight: 9.8 lbs. (4.5 kg)

Order #	Item #	Handing	Key Bypass
825-8100	UNI R8148B-26D-41	RH	Best
825-8101	UNI RR8148B-26D-41	RHR	Best
825-8105	UNI L8148B-26D-41	LH	Best
825-8106	UNI LR8148B-26D-41	LHR	Best
825-8120	UNI R8148S-26D-41	RH	Schlage
825-8121	UNI RR8148S-26D-41	RHR	Schlage
825-8125	UNI L8148S-26D-41	LH	Schlage
825-8126	UNI LR8148S-26D-41	LHR	Schlage
825-8130	UNI R8148R-26D-41	RH	Sargent
825-8131	UNI RR8148R-26D-41	RHR	Sargent
825-8135	UNI L8148R-26D-41	LH	Sargent
825-8136	UNI LR8148R-26D-41	LHR	Sargent

SIMPLEX Pushbutton Locks



Simplex 9600 Series Cabinet Locks

Application

9600 Series Cabinet Locks are specifically designed for cabinet doors, desk drawers, and similar applications. Ideal for use in many locations: medicine chests, liquor cabinets, gun boxes, courier pick-up boxes, home entertainment units, cleaning supply cabinets, tool chests, private files, display cases, supply cabinets, audio-visual cabinets, and petty cash drawers.

Can be used alone or in combination with other locking devices for maximum security

Features

- **Construction:** All metal, cast face plate
- **Installation:** Horizontal or vertical. two-step mortise installation using rougher or 5-1/2" x 1" slot with trim plate for wood applications. Punched slot or series of 7/16" drilled holes for metal applications.
- **Door Handing:** None
- **Numeric Keypad:** Vandal resistant, 5 button
- **Weight:** 1 lb.
- **Bolt:** End-throw/cross-throw deadbolt (with manual relock); end-throw spring latch (with automatic relock).
- **Door Thickness:** Wood doors: 5/8" to 7/8". Sheet metal applications: 20 to 14 gauge.

C9600 Series. Specially packaged with everything the "Do It Yourself" customer needs. For wood applications.

5/8" to 7/8" Thickness, End Throw/Hex Knob/Trim Plate included.

Order #	Item #	Type	Cat. Price
825-9601	C9601-26D-41	Deadbolt	\$96.00
825-9602	C9602-26D-41	Spring Latch	103.20

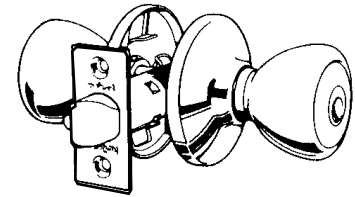

ANSI/BHMA Grade 3
Full 1" Solid Core Throwbolt

TYLO (T)

All of our TYLO locks are stocked with steel latches, including 200T and 300T's.

All with RCL x RCS
RCLXRCS: Round corner latches and round corner strikes

Item #	Backset	Order #	PRICE
200T-US3	2-3/8" Backset	455-0045	\$19.32
200T-US5	2-3/8" Backset	455-0046	21.48
200T-26D	2-3/8" Backset	455-0047	19.68
300T-US3	2-3/8" Backset	455-0048	21.36
300T-US5	2-3/8" Backset	455-0049	23.28
300T-26D	2-3/8" Backset	455-0050	21.48
400T-US3	Adj. Backset	455-0051	28.56
400T-US5	Adj. Backset	455-0052	30.72
400T-26D	Adj. Backset	455-0053	29.52

KD & PK (Protecto Keyed) 67767:

Tylo Knob, 2-3/8" Backset

455-0067	(U) 400T-US3	\$31.32
----------	--------------	----------------

Tylo PK34525

455-0068	400T US3 KD	31.32
----------	-------------	--------------

Master Key 57476

455-5991	KWI 5991 MK57476	\$4.20
----------	------------------	---------------

MASTER KEYED ENTRY LOCKS

TYLO KNOB, Adjustable Backset

Item #	Order #	Price
400T-US3-MK	455-0060	\$31.56
400T-26D-MK	455-0061	31.56



BELAIR (B)
Grade 3. ANSI A156.2

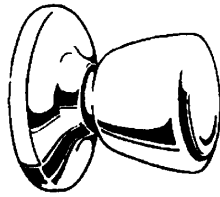

- Bolt: 1/2" throw for all functions except Tylo and Polo 200 and 300 which are 3/8" throw
- Crossbore: 2-1/8", Edge Bore 1", Latch Face: 1" x 2-1/4"
- Door Thickness: 1-3/8" to 1-3/4"
- Cylinder: 5 Pin
- Reversible

ITEM	2-3/8" backset		Price
200B-US3	(U) 455-0010	Passage	\$23.64
300B-US3	(U) 455-0018	Privacy	26.04
300B-26D	(U) 455-0019	Privacy	29.88

Item #	Adjustable Backset		Price
400BDL-26D	(U) 455-0028	Entry	44.16
450BDL-US3	(U) 455-0029	Storeroom	44.64

(U) Available while supplies last.

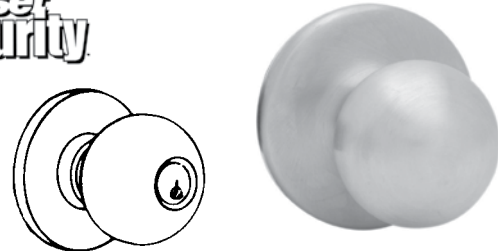

POLO (P)

ANSI/BHMA Grade 3
Full 1" Solid Core Throwbolt

Item #	Order #	Backset	Price
200P-US3 RCLxRCS	455-6223	2-3/8"	21.84
200P-US5	455-6225	2-3/8"	24.48
200P-15A Passage	455-0090	2-3/8"	24.48
200P-26D	455-6226	2-3/8"	22.32
300P-US3 RCLxRCS	455-6233	2-3/8"	24.24
300P-US5 Privacy	455-6235	2-3/8"	26.76
300P-15A	455-0092	2-3/8"	26.76
300P-26D	455-6236	2-3/8"	24.60
400PAL-US3 RCLxRCS	455-6243	2-3/8"	31.56
400PAL-US5 Entry	455-6245	2-3/8"	33.84
400P-15A	455-0093	2-3/8"	33.84
400PAL-26D	455-6246	2-3/8"	32.16

Dummy Trim, Polo Design

Order #	Item #	Cat. Price
455-0995	488P 26D	\$8.76

KWIKSET FUNCTIONS:

Exit (100) Patio doors, turn button interior, plain exterior. Can't be opened from exterior.

Passage (200) Interior doors, plain knob both sides. Always open.

Privacy (300) Bedroom, bathroom doors, turn button in interior knob locks both knobs.

Entry (400) Keyed exterior doors, Key from exterior and turn button from interior will lock or unlock both knobs.

Classroom (404) Plain, independent turning knob. When exterior is locked, interior will always open door.

Store Lock (442) Double cylinder. Both locks locked or unlocked simultaneously with key from either side.

Storeroom (450) Plain, independent turning interior knob and "always locked" exterior. When opened with key, knob remains locked when key is withdrawn.

FINISHES:

- US3: Bright Brass • US5: Antique Brass
- 15A: Antique Nickel • 26D: Satin Chrome

KWIKSET

Kwikset
Security

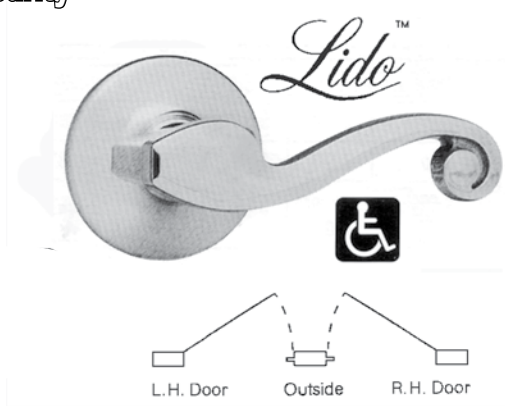

Premium Entrance Lockset

Exceptionally durable lockset providing extra strength and security. 6-pin cylinder.

Interior always opens lock.

LIDO (LL) Levers

Field reversible except for Dummy Trim

Lido Model with Lever on both Exterior and Interior.



Adjustable Latch

Order #	Item #	Price
455-6401	740LL-AL US3 RH	\$75.60
455-6402	740LL-AL US3 LH	75.60
455-6403	740LL-AL US5 RH	80.40
455-6404	740LL-AL US5 LH	80.40

KWIKSET

Kwikset
Security

kwikset®

Hancock

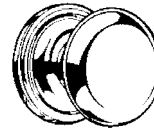

Lido

All with RCAL/RCS, 2-3/8" Backset
except 788 Dummy Set

Order #	Item #	Function	Cat. Price
455-6323	720LL RH US3	Passage	\$42.60
455-6328	720LL LH US3	Passage	42.60
455-6400	720LL RH US5	Passage	50.40
455-6405	720LL LH US5	Passage	50.40
455-7300	720LL RH 15A	Passage	50.40
455-7301	720LL LH 15A	Passage	50.40
455-7307	720LL LH 26D	Passage	50.40
455-6333	730LL RH US3	Privacy	45.00
455-6338	730LL LH US3	Privacy	45.00
455-6410	730LL RH US5	Privacy	53.40
455-6415	730LL LH US5	Privacy	53.40
455-7302	730LL RH 15A	Privacy	53.40
455-7303	730LL LH 15A	Privacy	53.40
455-7308	730LL RH 26D	Privacy	53.40
455-7309	730LL LH 26D	Privacy	53.40
455-7304	488LL RH 15A	Half Dummy	22.80
455-7305	488LL LH 15A	Half Dummy	22.80
455-7310	488LL RH 26D	Half Dummy	22.80
455-7311	488LL LH 26D	Half Dummy	22.80

Exterior Knob, Furnished with **ADJUSTABLE LATCH:**

455-6343	(U) 400LLAL L03 RH	Entry	59.64
455-6348	(U) 400LLAL L03 LH	Entry	59.64



Premium Security

Features including a 6-pin cylinder with pick resistant pins.

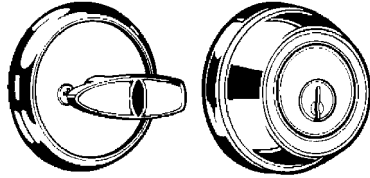

ANSI/BHMA A156.2 Grade 2 Security

Single Cylinder Deadbolts

Order #	Item #	Latch/Faceplate	Cat. Price
455-7150	780 11P	RCAL/SCS	61.80
455-7145	780 15A	RCAL/RCS	61.80
455-7140	780 26D	RCAL/SCS	61.80
455-7110	780 US3	RCAL/SCS	61.80

Mortise Thumb Turns, Turnbolts

Not visible from outside

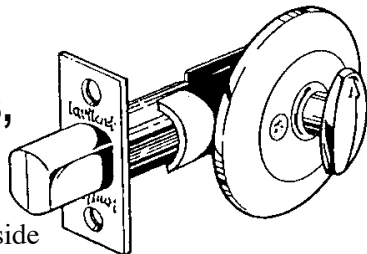

Mortise Thumb Turns:

Item #	Order #	Backset	PRICE
663-US3	455-0084	2-3/8"	\$14.88
663-US5	455-0085	2-3/8"	15.84
663-US5	455-0086	2-3/8" RFL	15.84
663-26D	455-0088	2-3/8"	15.12

DEADBOLTS



660 Series

1" Bolt, Rotating Cylinder Guard, 2-1/4 x 1" strike
RCAL: Round Corner Adj. Latch

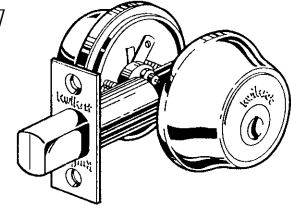

Single Cylinder:

Item	Adj.	Adj. DIB	Price
660-US3	455-0062	455-0063	\$30.24
660-US5	455-0065	455-0066	33.00
660-26D	455-0070	455-0071	31.08
660-15A	455-0064		33.00

Double Cylinder:

Item	Adj.	Adj. DIB	Price
665-US3	455-0073	455-0074	\$39.24
665-US5	455-0076	455-0077	41.88
665-26D	455-0081	455-0082	40.08
665-15A	455-0075		41.88

Gate Latch

Added safety with automatic exterior locking. Turnpiece can never be left in unlocked position. 2-3/8" Backset only.

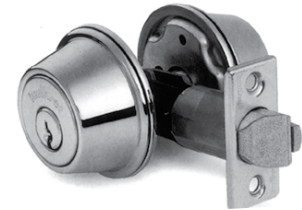

Single Cylinder:

Item #	Order #	PRICE
598-US3	455-5823	\$74.40
598-26D	455-5822	86.40

Double Cylinder:

599-US3	455-5833	\$87.60
599-26D	455-5832	98.40

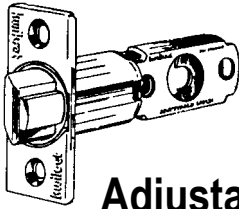

kwikset

Adjustable Bolts & Latches

Four (4) ways:

2-3/8" with rectangular face; 2-3/8" with round face
2-3/4" with rectangular face; 2-3/4" with round face

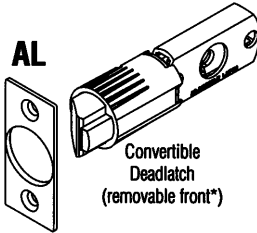

Adjustable Plainlatches:

455-2947	2947-US3	\$7.56
----------	----------	---------------

Adjustable Deadbolt:

Drive-in Deadbolt (4504)

455-4504	81306-US3	\$11.62
----------	-----------	----------------

Deadlatches

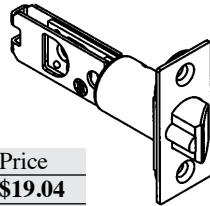

for Key-in-Knob locks:

Order #	Kwikset #	Backset	Price
455-3014	83014-26D	5"	\$19.04
455-2914	83014-US3	5"	19.04

5" For 660 Series Deadbolts:

455-2730	82730-26D	5"	15.96
----------	-----------	----	--------------

Kwikset Round Corner Latches, Plain

Order #	Item #	Backset	Price
455-0510	(U) 2993-01-US3-RCL	2-3/8"	5.40
455-0520	(U) 3006-01-US3-RCL	2-3/4"	5.40

Round Corner Deadbolts

Order #	Item #	Description	Price
455-0535	(U)2732-01-26D-RCL	2-3/4" Deadbolt	6.96
455-0540	(U)2732-01-US3-RCL	2-3/4" Deadbolt	6.96

(U) Available while supplies last

TITAN Replacement Latches.

For Titan Lock Sets:

Order #	Item #	Latch	Backset	Price
455-7200	(U)28-2974-US3-BP	Plain	2-3/8"	\$11.20
455-7205	(U)28-2974-26D-BP	Plain	2-3/8"	11.20
455-7225	(U)28-3003-26D-BP	Dead	2-3/4"	15.40

For Titan Deadbolts: \$12.68 each

Order #	Item #	Latch	Backset	Price
455-7240	(U)28-6084-US3-BP	Standard	Adjustable	
455-7245	(U)28-6084-26D-BP	Standard	Adjustable	

6-Way Adjustable Latches

6-Way Core

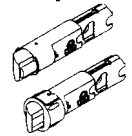

6-Way Core, Adjustable backset.

Order 6-Way Service Kit Below to complete the latch.

Order #	Item #	Type	Cat. Price
455-0560	81846	Deadlatch	\$8.68
455-0570	81847	Plain Latch	7.14

RC/SC/DI

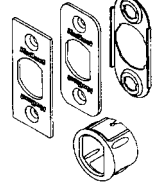

6-Way Service Kit. RC/SC/DI

Includes Round Corner, Square Corner, Drive-In Collar, and Back Plate

Order #	Item #	Type	Cat. Price
455-0580	81844 US3	Deadlatch	\$5.04
455-0600	81844 26D	Deadlatch	5.04
455-0590	81845 US3	Plain Latch	3.92
455-0610	81845 26D	Plain Latch	3.92

RCAL

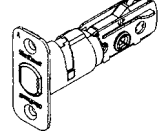

Kwikset Security Standard.

RCAL (Round Corner Adjustable Latch)

Adjustable Backset, 1" Front Deadlatch.

Will not work with 663 deadbolt.

Order #	Item #	Price
455-0620	81305 US3	\$11.62
455-0630	81305 US26	11.62

DOOR LOCKS

WIKSET



Achieves ANSI A 156.2, Grade 2 rating - the highest residential grade possible as established by the American National Standards Institute.

- National Police Officers Association of America endorsed.
- Full 50-year warranty.
- Compatible with Kwikset's 5-pin keying systems.
- Made in USA. • BP: Box Packed.

Knob Lock Specifications:

Door Prep:	Front: 2-1/8"; Edge Bore: 7/8", 15/16", 1". Latch Face: 1" x 2-1/4"
Backset:	2-3/8"
Faceplates:	1" x 2-1/4" square corner standard
Door Thickness:	1-3/8" to 1-3/4" doors.
Cylinder:	6-pin zinc. Front removable cylinder standard.
Strike:	2-1/4" high full lip square corner .
	• Reversible • 1/2" Throw Latchbolt • Box Packed

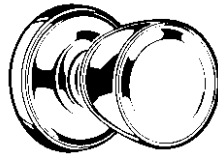

Abbey Knob,

2-3/8" Backset

Order #	Item #	Function	Price
455-7000	720A-US3	Passage	\$28.80
455-7005	720A-26D	Passage	33.60
455-7010	730A-US3	Privacy	31.80
455-7015	730A-26D	Privacy	36.00
455-7020	740A-US3-KA2	Entry	57.00
455-7025	740A-26D-KA2	Entry	64.20

with Abbey Knob Design, Adjustable Backset

Order #	Item #	Function	Price
455-7026	741A AL US3 BP	Entry	\$61.20
455-7027	741A AL 26D BP	Entry	68.40
455-7028	750A AL US3 BP	Storeroom	61.20
455-7029	750A AL 26D BP	Storeroom	68.40
455-7030	744A AL US3 BP	Classroom	61.20
455-7031	744A AL 26D BP	Classroom	68.40
455-7032	(U) 701A AL US3 BP	Double Cyl.	63.40
455-7033	(U) 701A AL 26D BP	Double Cyl.	68.88



700 Series Knob Locks

ANSI/BHMA A156.2
Grade 2 Security
Anti-pick 6 Pin System

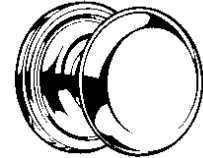

All with RCAL/RCS,
except 788 Dummy Set

Order #	Item #	Function	Cat. Price
455-7050	720H-US3	Passage	\$27.60
455-7060	720H-US5	Passage	34.80
455-8070	720H 11P	Passage	34.80
455-8050	720H 15A	Passage	34.80
455-7055	720H 26D	Passage	34.80
455-7065	730H-US3	Privacy	30.60
455-7075	730H-US5	Privacy	37.20
455-8075	730H 11P	Privacy	37.20
455-8055	730H 15A	Privacy	37.20
455-7070	730H 26D	Privacy	37.20
455-7080	740H-US3-KA2	Entry	55.20
455-7090	740H-US5-KA2	Entry	63.00
455-8080	740H 11P	Entry	63.00
455-8060	740H 15A	Entry	63.00
455-7085	740H-26D KA2	Entry	63.00
455-8085	788H 11P	Half Dummy	15.60
455-8065	788H 15A	Half Dummy	15.60
455-8090	788H 26D	Half Dummy	15.60

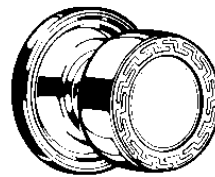

Roman Knob

Order #	Item #	Function	Price
455-7095	(U) 720R-US5	Passage	\$28.50

Dummy Knobs. Brass Finish

Order #	Item #	Knob Style	Price
455-1000	488 US3	Polo	\$8.52
455-1005	(U) 488 US3	Tylo	7.56
455-1010	788 US3	Hancock	13.20



LAUREL KNOB

This proven high end design is a welcome addition to the Kwikset UltraMax Signatures family winning the Design Journal Award for Design Excellence. The Laurel's classic style is sure to make a lasting impression.

- ANSI/BHMA A156.2 Grade 2 Security
- Anti-pick 6 Pin System
- Concealed Screws
- Decorative Egg Shaped Knob
- Kwik-Install Installation



Order #	Item #	Function	Catalog Price
455-0120	720L 11P	Passage	\$60.60
455-0715	720L US15	Passage	60.60
455-0100	720L 15A	Passage	60.60
455-0125	730L 11P	Privacy	64.20
455-0720	730L US15	Privacy	64.20
455-0105	730L 15A	Privacy	64.20
455-0130	740L 11P	Entry	105.60
455-0725	740L US15	Entry	105.60
455-0110	740L 15A	Entry	105.60
455-0135	788L 11P	Half Dummy	27.60
455-0730	788L US15	Half Dummy	27.60
455-0115	788L 15A	Half Dummy	27.60

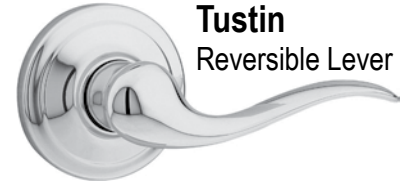

Tustin Reversible Lever

TUSTIN LEVER

- ANSI/BHMA A156.2 Grade 2 Security
- Reversible Lever – Fits both right handed and left handed doors
- Fashionable and Stylish wave silhouette design

Order #	Item #	Function	Cat. Price
455-1210	200TNL 11P	Passage	\$50.40
455-1215	300TNL 11P	Privacy	53.40
455-1220	405TNL 11P	Entry	80.40
455-1240	200TNL 26D	Passage	50.40
455-1245	300TNL 26D	Privacy	53.40
455-1250	405TNL 26D	Entry	80.40
455-1255	488TNL LH 26D	Dummy	22.80
455-1260	488TNL RH 26D	Dummy	22.80

Half Dummy, handed:

455-1225	488TNL 11P RH	\$22.80
455-1235	488TNL 11P LH	22.80

Handleset Interior Packs

L: Laurel Knob

RCALxRCS

Order #	Item #	Function	Cat. Price
455-0735	966L US15	Single Cyl.	\$66.00



LL: Lido Lever

Order #	Item #	Function	Cat. Price
455-8005	966LL RH 15A	RCAL/RCS	\$66.00
455-8010	966LL LH 15A	RCAL/RCS	66.00
455-8035	966LL RH 26D	RCAL/RCS	66.00
455-8040	966LL LH 26D	RCAL/RCS	66.00



H: Hancock

455-8025	966H 11P	RCAL/RCS	\$55.20
455-8015	966H 15A	RCAL/RCS	55.20
455-8045	966H 26D	RCAL/RCS	55.20

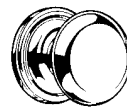

TUSTIN LEVER Handleset Interior Packs



- ANSI/BHMA A156.2 Grade 2 Security
- Reversible Lever – Fits both right handed and left handed doors
- Fashionable and Stylish wave silhouette design

Single Cylinder Interior Pack

11P: Venetian Bronze

RCALxRCS, Satin Chrome finish

Order #	Item #	Cat. Price
455-0740	966TNL 26D LH	\$66.00
455-0700	966TNL 26D RH	66.00
455-0705	966TNL 11P LH	66.00
455-0710	966TNL 11P RH	66.00

kwikset

Powerbolt®

Powerbolt® provides the convenience of keyless access for today's active lifestyle. The latest in electronic technology operates on just 4 AA batteries and permits access with your personalized code or a key. It is easy to install, easy to program and easy to use. Powerbolt requires no wiring and easily replaces existing door hardware.



Exterior

- One Touch Locking, Full 1" Projection Deadbolt
- Four to Eight Digit Personal Entry Code, Two Code Capacity
- Easy to Install, Easy to Program, Easy to Use
- No Wiring, Uses 4 AA Alkaline Batteries, Low Battery Indicator Light Alerts When Batteries are Low.

Order #	Item #	Catalog Price
455-2010	KWI 907 x 11P	\$228.00
455-2000	KWI 907 x L03	228.00



DORIAN LEVERSETS

Etched detailing at the tip of the lever lends an air of elegant sophistication to the Dorian. Its graceful styling feels right at home in a wide range of décor.

- ANSI/BHMA A156.2 Grade 3 Security
- Classic Styling
- Easy to Operate, Non-Handed Lever Design

Order #	Item #	Function	Catalog Price
455-6620	200DNL 26D	Passage	\$42.24
455-6630	300DNL 26D	Privacy	44.76
455-6640	405DNL 26D	Entry	68.64

Dorian Half Dummy. Satin Chrome finish

Order #	Item #	Catalog Price
455-0745	488DNL 26D Dorian	\$18.48

kwikset
Pocket Door
Locks

Our innovative round design fits a standard 2-1/8" drilled door, allowing easy installation with a standard screwdriver.



Interior

- Innovative Round Design Fits Standard 2-1/8" Door Prep
- Easy Installation
- Round Design Prevents Traditional Door Warping
- Large Privacy Turnpiece



335 Locking:

Locked and unlocked by emergency tool outside and thumbpiece inside



334 Non-Locking:

Deep cups for easy access on passage doors.

Order #	Item #	Catalog Price
455-3340	334 10B Passage	\$32.64
455-3345	334 26D Passage	32.64
455-3350	335 26D Privacy	36.24

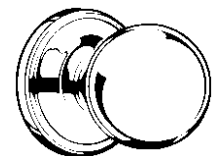

Circa Knob

2-3/8" Backset.

Order #	Item #	Function	Price
455-6530	KWI 720CA US3	Passage	37.20
455-6535	KWI 720CA US26D	Passage	44.40
455-6540	KWI 730CA US3	Privacy	41.40
455-6545	KWI 730CA US26D	Privacy	48.60
455-6550	KWI 740CA US3	Entry	69.60
455-6555	KWI 740CA US26D	Entry	79.80

kwikset

TITAN Handlesets

Solid Protection With a Lock That Complements any Architectural Style.

Solid forged-brass handlesets house an all-steel rack & pinion mechanism and 1-inch steel deadbolt to resist forcible entry.

Specifications:

Door Thickness: 1-3/4" thick.

Backset: 2-3/8"

Bore: 2-1/8" on door face, 1" on door edge.

Reversible. 1" throw deadbolt.

Full lifetime manufacturer's warranty.

Single Cylinder, Circa Knob on Interior.



Order #	Item #	Design	Cat. Price
455-0763	800ANxCA US3	Arlington	\$240.60
455-0760	800CEx966CA US3	Chelsea	240.60

LIP: Less Interior Package (Trim)

Order #	Item #		Cat. Price
455-8000	800CE LIP 15A	Chelsea	\$208.20
455-8030	800CE LIP 26D	Chelsea	208.20
455-8020	800CE LIP 11P	Chelsea	208.20

Kwikset Security 600 Series Handlesets

- **Backset:** Adjustable latch
- **Door thickness:** 1-3/8" to 1-3/4" doors
- **Faceplates & Strikes:** 1" x 2-1/4" square corner standard
- **Bolt:** 1" Throw
- **Reversible** for right or left hand doors.
- **A156.5 Grade 3.**
- **Function:** Thumbturn x Plate: deadbolt operated thumbturn on interior. Blank plate on exterior. ULListed.

Single Cylinder Handleset. Dakota style with Copa Interior knob.

Order #	Item #	Catalog Price
455-0687	687DAXC US3	\$157.08

Dummy Handleset with Copa Interior Knob

455-0699	699DAXC US3	\$142.72
----------	-------------	----------



kwikset

Standard Duty Handlesets.

660 Series Deadbolt 2-3/8" Backset. Copa knob on inside.

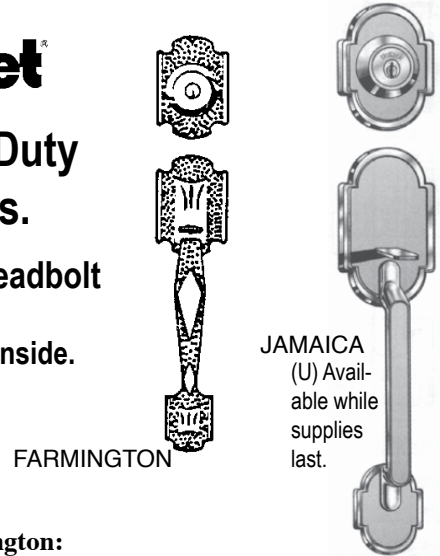

Design - Farmington:

Order #:	Item #	Cylinder	Price
455-0670	687FN x C US5	Single	125.40
455-0675	689FN x C -US5	Double	166.80

Handlesets & Dummy Handlesets

with Deadbolt Trim. Copa knob on inside.

Order #	Item #	Trim	Description	Price
455-0678	699FNxC US5	Farmington	Dummy	\$107.64
455-0683	683 US3 (U)	Jamaica	Dummy	51.84

kwikset

Standard Duty Handleset LIP: Does not include interior package; order separately

RCL; RCS: Round Corner Latch; Round Corner Strike

LIP: Less Interior Package
Single Cylinder. Antique Nickel Finish

Order #:	Item #	Design	Catalog
455-0680	687FN-15A LIP	Farmington	\$76.92

Interior Package, "Dorian" for 687FN Handleset

455-0685	604DNL 15A	Dorian interior pkg	\$58.80
----------	------------	---------------------	---------



ULTRAMAX Deadbolts

Specifications:

Door Prep:	Front: 2-1/8"; Edge Bore: 1" Latch Face: 1" x 2-1/4"
Backset:	2-3/8" or 2-3/4" adjustable deadbolt latch.
Faceplates:	1" x 2-1/4" square corner standard
Door Thickness:	1-3/8" to 1-3/4" doors.
Cylinder:	6-pin zinc. Front removable cylinder standard
Strike:	Maximum security 1-1/4" x 3-5/8" square corner with extra long 3" screws.
Bolt:	1" Throw, with free turning hardened steel insert.
Packaging:	Boxed packed

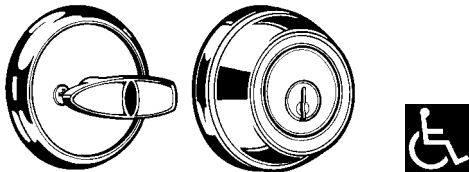

Single Cylinder Dead Bolt

455-7110	780-US3-BP-KA2	\$52.20
455-7115	780-26D-BP-KA2	61.80
455-7120	780-US5-BP-KA2	61.80

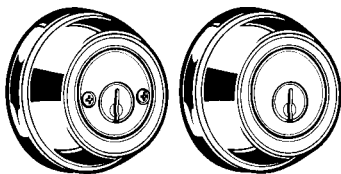

Double Cylinder Dead Bolt

455-7125	785-US3-BP-KA2	\$79.80
455-7130	785-26D-BP-KA2	85.20
455-7135	785-US5-BP-KA2	85.20

ULTRAMAX Deadbolts

kwikset®

Mobile Home Locks



7/8" Round Face Drive-In Latch
- Square Corner Strike

(U) Mobile Home Locks

Fit Doors 1-1/8" to 1-1/2" Thick

"Tylo" Design Knobs

Order #	Item #	Function	Price
455-0230	400M US3 RFL KA2	Entry	\$26.16

Available only while supplies last

DOOR LOCKS



Key-In-Lever

Commonwealth Series

Commonwealth lever combines beauty, strength, and durability and is engineered with ANSI Grade 2 performance and strength.

- Consumer preferred design adds elegance & versatility to any home.
- Patented design on entry function provides greater gripping area
- Hidden screws on the entry function offers cleaner design.
- Non-handed interiors.
- High security 6-pin cylinder standard: all exterior entry functions.
- ANSI A156.2 Grade 2 performance.
- Lifetime mechanical & 10 year finish manufacturer's warranty
- Entry function utilizes the Titan Commercial chassis;
- 1" adjustable backset latch is standard. 6-pin keying.

Door Prep: • Crossbore: 2-1/8"; Edge Bore: 1";
• Latch face: 1" x 2-1/4" • 1-3/8" to 1-3/4" thick doors.

Order #	Item #	Function	Price
455-5500	730 CHL 605 BP*	Privacy	\$54.00
455-5510	720 CHL 605 BP*	Passage	51.00
455-5520	788 RH CHL 605 BP	Dummy	23.40
455-5530	788 LH CHL 605 BP	Dummy	23.40
455-5540	740 RH CHL 605 BP*	Entry	94.20
455-5550	740 LH CHL 605 BP*	Entry	94.20

*RCAL x RCS RH: Right Hand; LH: Left Hand

Kwikset Plus Levers: Delta

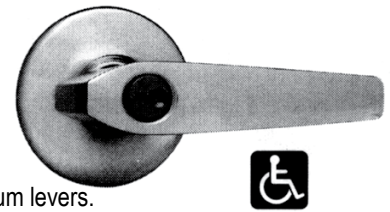

- Levers with fit, feel, and improved durability of premium levers.
- Patented ergonomic design allows for maximum handgrip area.
- Stylish security for entry doors.

Delta Lever

Order #	Item #	Description	Price
455-0400	200DL 26D RCL RCS	Passage	\$42.24
455-0405	200DL US3 RCL RCS	Passage	39.72
455-0410	300DL 26D RCL RCS	Privacy	44.76
455-0415	300DL US3 RCL RCS	Privacy	42.12
455-0420	405DL 26D RCL RCS	Entry	68.64
455-0425	405DL US3 RCL RCS	Entry	65.76
455-0430	488DL US26D	Half Dummy	18.48
455-0435	488DL US3	Half Dummy	16.20

Kwikset Maximum Security Lever

Specifications:

Door Prep: Crossbore 2-1/8", Edge Bore 1", latch Face 1" x 2-1/4"

Backset: Adjustable Backset

Door Thickness 1-3/8" to 1-3/4" door

Cylinder: 5-pin

Bolt: 1/2" Throw

Handing: Non-handed

ANSI A156.2 Grade 2

RCL; RCS: Round Corner Latch; Round Corner Strike



Dorian Lever

Order #	Item #	Function	Catalog
455-6600	200DNLAL 15A	Passage	\$42.24
455-6605	300DNLAL 15A	Privacy	44.76
455-6610	405DNLAL 15A	Entry	68.64

LCL

KWIKSET LCL Series

"Low Cost Locks"
Bargain
Deadbolt!

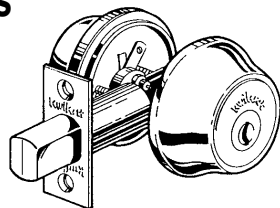

Adjustable Backset

LCL

Single Cylinder

Order #	Item #	Price
455-1315	119 LCL US3	\$21.24

Double Cylinder

455-1325	120 LCL US3	\$24.24
455-1326	120 LCL US5	19.34
455-1327	120 LCL US26D	24.24

DOOR LOCKS

KWIKSET LCL "Low Cost Locks"

Bargain Locksets!



- Box Pack Product
- Adjustable Latch RCAL/RCS - fits all doors
- Kwikset Keyway (KA-6)
- High Quality Import Product - 3 Year Manufacturer's Warranty.
- Edmonton Ball Knob

Order #	Item #	Function	Price
455-0300	114 BK3	Passage	\$16.32
455-0310	114 BK5	Passage	12.10
455-0315	114 BK 32D	Passage	16.32
455-0320	115 BK3	Privacy	17.64
455-0325	115 BK5	Privacy	12.60
455-0330	115 BK 32D	Privacy	17.64
455-0340	116 BK3	Entry	21.12
455-0350	116BK 32D	Entry	21.12

LORI

ILCO (formerly Lori) Standard Deadbolts For 4500 Series Locks:

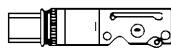

Drive In Bolt

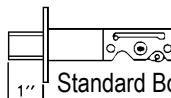

Standard Bolt

Order #	Lori #	Backset	\$
505-2600	4600-03-5004 x 4500-03-5010-US3	2"	\$21.98
505-4505	4500-03-5000 x 4500-03-5010-US3	2-3/8"	21.36
505-4506	4500-25-5000 x 4500-25-5010-26D	2-3/8"	21.36
505-4525	4540-03-5014 x -US3	2-3/8" DIB	21.28
505-4515	4510-03-5001 x 4500-03-5010-US3	2-3/4"	21.36
505-4516	4510-25-5001 x 4500-25-5010-26D	2-3/4"	21.36
505-4535	4550-03-5001 x US3	2-3/4" DIB	21.28

LORI Deadbolts by KABA ILCO

**USES ANY
MORTISE
CYLINDER!**

Your cylinder
here (cylinder not
included)

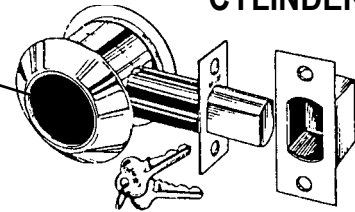

Heavy duty cylinder housing with one inch throw bolt (two hardened steel pins). Double cylinder has no exposed screws. **Furnished less cylinder.** Uses standard 1" or 1-1/8" mortise cylinders, one for a single cylinder deadbolt and two (one pair) for each double cylinder deadbolt.

Any manufacturer's mortise cylinder will fit, including high security. Order cylinders from "Replacement Cylinders" section in back of this catalog.

NOTE: Cylinders not included.
DIB denotes Drive-In-Bolt

SINGLE CYLINDER. 2-3/8"

Item #	Order #	Price
4513-04-03-0 US3	505-4500	\$58.62
4513-04-05-0 US5	505-4502	62.70
4513-04-26D-0	505-4501	62.70
4515-04-03-0 US3 DIB	505-4540	58.62
4515-04-26D-0 DIB	505-4541	62.70

SINGLE CYLINDER. 2-3/4"

4514-04-03-0 US3	505-4510	\$58.62
4514-04-05-0 US5	505-4512	62.70
4514-04-10B-0	505-4503	76.70
4514-04-26D-0	505-4511	62.70
4516-04-03-0 US3 DIB	505-4550	58.62
4516-04-26D-0 DIB	505-4551	62.70

DOUBLE CYLINDER. 2-3/8"

4523-04-03-0 US3	505-4520	\$57.52
4523-04-05-0 US5	505-4522	62.22
4523-04-26D-0	505-4521	62.22
4525-04-03-0 US3 DIB (U)	505-4560	57.52
4525-04-26D-0 DIB	505-4561	62.22

DOUBLE CYLINDER. 2-3/4"

4524-04-03-0 US3	505-4530	\$57.52
4524-05-05-0 US5	505-4532	62.22
4524-04-10B-0	505-4523	70.86
4524-04-26D-0	505-4531	62.22
4526-04-03-0 US3 DIB	505-4570	57.52
4526-04-26D-0 DIB	505-4571	62.22

DOOR LOCKS



SURVIVOR SERIES

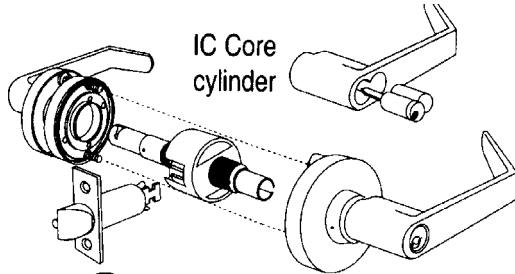

American Lever

195 SERIES

Grade 1 Cylindrical Lever Sets ANSI-A156.2, 3 Hour UL Fire Rating Featuring "The Clutch"

- 2-3/4" Backset
- Latch Front: 1-1/8" x 2-1/4"
Throw: 9/16" Stainless steel nose
- Levers: Solid cast Zamac; w/1/2" return
- Roses: Thru-bolted 3-7/16" diameter;
spring loaded 2-#10 thru-bolts.
- Strike: 4-7/8" ASA curved lip strike
- Door thickness: 1-5/8" to 1-7/8"
- Cylinder: **LESS CYLINDER**

Order #	Item #	Function	Catalog Price
540-0010	195N 26D	Passage	\$190.80
540-0020	195L 26D	Privacy	202.80
540-0030	195AB 26D	Entry	202.80
540-0040	195S 26D	Classroom	202.80
540-0050	195F 26D	Storeroom	202.80

For Small Format Interchangeable Core (Less Core)

Order #	Item #	Function	Catalog Price
540-0130	195RAB 26D IC	Entry	\$211.80
540-0140	195RS 26D IC	Classroom	211.80
540-0150	195RF 26D IC	Storeroom	211.80

Deadlatch for Grade 1 Lockset. 2-3/4" Backset

540-0160	1834A 32D	\$43.20
----------	-----------	---------

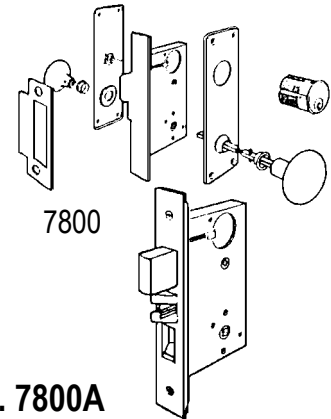

Classic Mortise Lockset.

Entrance Function. 7800A

2-3/4 backset; 1" Bolt throw; 5/8" Latch throw. High pressure cast case. Front: 1-1/4 x 8 with solid brass armor plate.

Can be beveled. (Single cylinder included)

540-7800	US3	\$531.60
540-7801	26D	531.60

Mortise Deadlocks

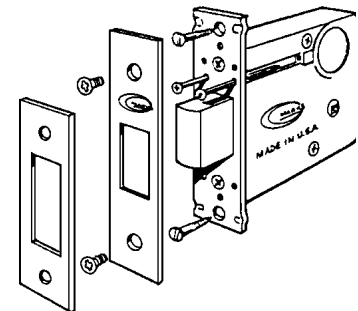

1" Bolt throw.
High pressure cast case.

Front: 1-1/16 x
4-5/8 with cover plate, can be beveled. Reversible,
strike and screws included.

3000 Series, 2-3/4" backset:

540-3000	26D	\$100.80
540-3001	US3	\$100.80

2000 Series, 2-1/2" backset:

540-4000	26D	\$100.80
540-4001	US3	\$100.80



Contract Line

**1150 Series
Cylindrical Lever Sets**

**ANSI Grade 2, UL Listed 3 hours
Standard Features**

- Levers: American Design
- Roses: 3-5/16" Diameter
- Backset: 2-3/4" Standard
- Latch: Stainless steel Latch Nose, 1/2" throw.
1-1/8" x 2-1/4" front
- Cylinder: Marks "C" keyway, 6 pin w/2keys
- Handing, reversible, Non-handed
- Strike: 4-7/8" ASA standard

Order #	Item #	ANSI #	Function	Cat. Price
540-1020	1150N 26D	F75	Passage	\$60.06
540-1220	1150N US3	F75	Passage	61.70
540-1120	1150N 10B	F75	Passage	72.08
540-1015	1150L 26D	F76	Privacy	63.34
540-1215	1150L US3	F76	Privacy	64.98
540-1115	1150L 10B	F76	Privacy	74.80
540-1000	1150AB 26D	F109	Entrance	67.70
540-1200	1150AB US3	F109	Entrance	69.34
540-1100	1150AB 10B	F109	Entrance	84.60
540-1010	1150S 26D	F84	Classroom	73.16
540-1210	1150S US3	F84	Classroom	74.80
540-1110	1150S 10B	F84	Classroom	85.18
540-1005	1150F 26D	F86	Storeroom	67.70
540-1205	1150F US3	F86	Storeroom	69.34
540-1105	1150F 10B	F86	Storeroom	79.72

With 2-3/8" Backset

540-1400	1150AB 26D	Entrance	67.70
540-1405	1150F 26D	Storeroom	67.70



Can Be
Assembled
With or Without
Thru-studs

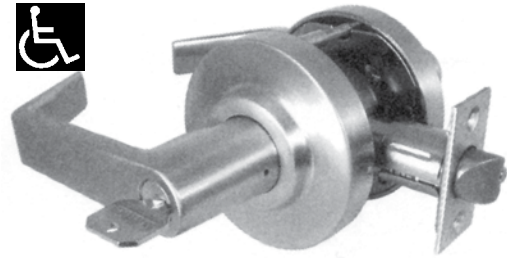

- Door Thickness: 1-3/8" to 1-3/4"
- Studs: Removable thru-bolts
- Over-under
- Life Test: 1,000,000+ cycles
- ANSI Test: Exceeds ANSI A156.2, Grade 2
- Fire Test: UL Listed, 3 hour fire rated
- Manufacturer's 5 Year Limited Mechanical Warranty.

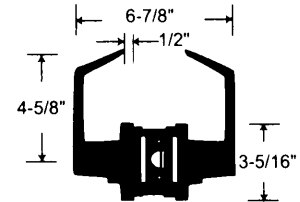

Marks HI-SECURITY™ IC Core Models
Same Features as Cylindrical Lever Sets

- Interchangeable Core models for 6 or 7 pin cores (NOT INCLUDED). Accepts: Marks, Marks HI-SECURITY, Medeco, KeyMark, Falcon, Schlage small format & Best IC Core. Tailpieces ARE included.

Order #	Item #	ANSI #	Function	Cat. Price
540-1300	1150RAB 26D	F109	Entrance	\$67.70
540-1305	1150RF 26D	F86	Storeroom	67.70
540-1310	1150RS 26D	F84	Classroom	73.16

Grade 2 Latches for 1150 Series

Order #	Item #	Description	Cat. Price
540-1500	1138A 26D	2-3/8" deadlatch	\$21.00
540-1510	1138A US3	2-3/8" deadlatch	21.00
540-1520	1138N 32D	2-3/8" plain latch	16.80
540-1530	1138N US3	2-3/8" plain latch	16.80

**Lever/Rose
Mortise Lockset**

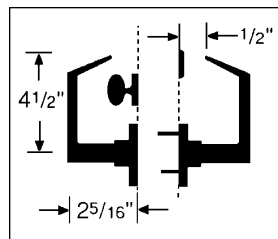
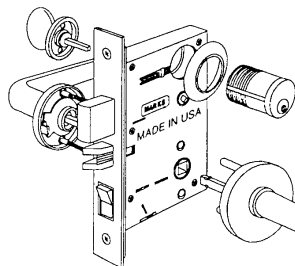























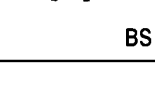

- Thru-bolted lever/rose assemblies w/lever support springs.
- Steel, reinforced brass roses, 2-9/16" dia. x 3/8"
- Solid forged brass, screwless levers.
- Independent spring loaded 5/16" spindles.
- Solid bar stock, brass cylinders, 5 pin.
- Reversible mortise lock with lever support springs.

Order #	Item #	Function	Price
540-0200	7690A/26D	Entry	\$531.60
540-0205	5690EW/26D	Storeroom	559.20

CYLINDRICAL KNOB & LEVER FUNCTIONS

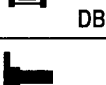
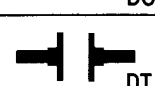
ANSI# CODE	MARKS FUNCTION	ANSI# CODE	MARKS FUNCTION
F75	N	F89	FQ
F76	L	F90	T
F77	P	F90	TK
F80	DC	F92	BS
F81	A	F93	H
F82A	B	F109	AB
F83	AQ	F110	DB
F84	S	F111	NB
F86	F	F112	FB
F87	DW	F113	SB
F88	DA		

ANSI #	MARKS FUNCTION
F75: PASSAGE Latch by lever either side.	  N
F76: PRIVACY Latch by lever either side unless outside lever locked by push button from inside. Outside unlocks by turning inside lever, outside emergency turn or closing door.	 L
F77: PATIO Deadlocking latch by lever either side unless outside lever locked by push button inside. Unlocks by turning inside lever or closing door.	 P
F80: COMMUNICATING Key both sides. Locks or unlocks either lever independent of the other. Deadlocking latch.	 DC
F81: ENTRY Deadlocking latch bolt by lever either side except when outside locked by turn button inside. When outside locked, key outside or lever inside opens lock. Turn button operated manually.	 A
F82A: ENTRY Deadlocking latch by lever either side. Outside locked by push button inside. When outside locked by push button inside, key opens lock, unlocks push button. Inside lever always opens latch. Closing door does not release push button.	 B
F83: EXIT Deadlocking latch by lever either side except when outside locked by turn button inside. Inside lever always opens latch. Turn button operated manually.	 AQ
F84: CLASSROOM Deadlocking latch by lever inside. Outside lever locked or unlocked by key.	 S
F86: STOREROOM Deadlocking latch by lever inside, key outside. Outside lever always locked.	 F
F87: INSTITUTION Both levers always locked. Deadlocking latch by key both sides.	 DW
F88: VESTIBULE Deadlocking latch by lever either side, except when outside lever locked by key inside. Key outside retracts deadlocking latch. Inside always open.	 DA

ANSI #	MARKS FUNCTION
F89: EXIT Deadlocking latch by lever inside. Outside always locked.	 FQ
F90: CORRIDOR Deadlocking latch by lever either side unless outside locked by key or inside push button. Unlock by key, turning inside lever or closing door.	 T
F90 MOD.: HOSPITAL/PRIVACY Deadlocking latch by lever either side unless outside locked by knob or inside push button. Unlock by knob, turning inside lever or closing door.	 TK
F92: SERVICE STATION LOCK Deadlocking latch by lever either side unless outside locked by key or inside push button. Unlock by key, turning inside lever or closing door, except when slotted push button is turned in locked position. Inside lever always opens latch.	 BS
F93: HOTEL Deadlocking latch by lever inside. Outside lever always locked. Inside push button projects indicator on cylinder face shutting out all keys except emergency key. Turning inside lever or closing door releases push button.	 H
F109: ENTRY Outside locked by pushing turn button inside. Key outside opens lock. Rotating inside lever releases button and outside lever. By pushing and turning inside button, outside lever remains locked. Deadlocking latch.	 AB
F110: CLASSROOM INTRUDER Deadlocking latch by lever either side, except when outside locked by key inside. Key outside locks or unlocks outside. Inside always open	 DB
DUMMY TRIM: Outside only, rigid.	 DO
DUMMY TRIM: Both sides, rigid.	 DT
F111: COMMUNICATING PASSAGE: Blank outside. Deadlocking latch by lever inside.	 NB
F112: COMMUNICATING STOREROOM: Blank outside. Deadlocking latch by key only. Lever always locked.	 FB
F113: COMMUNICATING CLASSROOM: Blank outside. Inside lever locked or unlocked by key. Deadlocking latch.	 SB
ELECTRICALLY LOCKED: Outside always locked electrically. Open by key outside, switch or loss of power. Deadlocking latch by lever inside. Lever only.	 FEL
ELECTRICALLY UNLOCKED: Outside always locked until unlocked by key or electrically energized. Deadlocking latch by lever inside. Lever only.	 FEU

NOTE:
These functions are available with knob or lever, as indicated.

MARKS

DOOR LOCKS

MARKS

Series SS50 Institutional Life Safety Mortise & Cylindrical Knobsets



5SS50G Mortise Locksets

Trim Specifications:

Exterior and Interior Trim. Solid brushed chrome interior and exterior trim including finger indented safety knobs which recess into solid brass through-bolted roses.

- **ANSI:** 156.13, Grade 1, UL Listed, 3 Hour fire rated
- **Cylinder:** Solid brass cylinders with solid brass security collars
- **Strike:** 4-7/8" curved lip with tamper-proof screws
- **Backset:** 2-3/4" • **Door Thickness:** 1-3/4" Standard
- **Door Prep:** ANSI A115.1 lock face cutout with 2-1/8 thru-hole for knob/rose assembly
- **Lock Front:** Adjustable bevel steel backplate and cover plate with tamper proof screws.

ANSI F09 Entrance (G Function). Inside/outside key cylinders. Both inside and outside knob can be left in "passage" mode. Turning key from either side locks both knobs.

Order #	Item #	Catalog Price
540-5050	5SS50G 26D	\$1288.80



Institutional Locks

1SS50K Cylindrical Deadlatch Locksets

- **ANSI E0121 Cylinder x Knob:** Latch by knob inside, key outside
- **Strike:** #1136, 2-3/4" T-Strike
- **Door Prep:** ANSI 115.2
- **Latch:** ANSI 156.2, Grade 1, UL Listed, 3 Hour fire rated
- **Backset:** 2-3/4" • **Door Thickness:** 1-3/4"
- **Latch Face:** 1-1/8" x 2-1/4" with tamper proof screws
- **Cylinder:** Solid brass cylinder, 6-pin "C" keyway
- Unitized cylinder/security collar assembly for 2-1/8" bore
- Thru-bolted knob assembly, 2 each 1/4" bolts thru latch

Order #	Item #	Catalog Price
540-5010	1SS50K	\$1094.40



Institutional Locks

70 Line, Grade 2 Cylindrical SURVIVOR Leversets



Charlotte Warehouse Only

- **Backset:** 2-3/4"
- **Latch:** #1134, **Front:** 1-1/8" x 2-1/4"; **Throw:** 1/2"; Stainless Steel Nose
- **Levers:** Solid cast Zamac; w/1/2" return
- **Roses:** Thru-bolted, 3-1/4" dia., spring loaded 2-#10 thru-bolts
- **Strike:** #1136, 2-3/4" T-strike
- **Door Thickness:** 1-5/8" to 1-7/8"
- **Cylinder Codes:**
I.C.: Small Format IC, Less Core
L.C.: Less Cylinder



Order #	Item #	Function	Catalog Price
540-1430	170N 26D	Passage	\$151.80
540-1435	170L 26D	Privacy	162.60
540-1410	170AB 26D I.C.	Entry	172.80
540-1415	170RF 26D I.C.	Storeroom	172.80
540-1420	170AB 26D G3	Entry	163.80
540-1425	170F 26D G3	Storeroom	163.80
540-1440	170S 26D G3	Classroom	163.80

Master Lock



Advanced Cylinder Technology

The only deadbolts that prevents an intruder from entering a home. . . Even if they have the key. It can't be "bumped" or "picked" . . . period.

Both NightWatch models fit all doors and replace all brands

- Forever lifetime finish guarantee on exterior functions. Powder Coat on interior functions provides lifetime finish protection.
- Concealed screws to improve appearance and simplify installation
- Hardened steel core throw-bolt resists cutting
- Anti-pry collar on exterior functions
- Six way adjustable latch - 2-3/8" to 2-3/4", Square, radius and drive-in latch face options.
- Exceeds ANSI Grade 2 specifications.

NightWatch Deadbolt

- When the patent-pending NightWatch feature is engaged, the lock cannot be opened from the outside. Not "Bumped", not "Picked", or even opened with a key.
 - Can only be engaged or disengaged from inside the house.
 - Provides extra nighttime security.
 - Installs like a standard deadbolt with just a phillips screwdriver.
 - Master Lock exclusive patented technology.
- To operate: Turn lever to lock deadbolt. Press up on safety button while pulling lever out to engage NightWatch lockout feature.

NightWatch Single Cylinder Deadbolts, Box pack.

Order #	Item #	Finish	Catalog Price
555-3030	DSNRN0603P	Bright Brass	\$44.14
555-3035	DSNRN0605	Antique Brass	40.66
555-3040	DSNRN0615	Satin Nickel	44.14

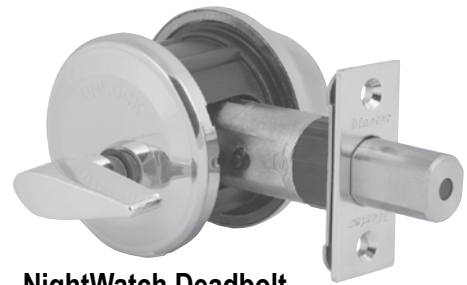

NightWatch Deadbolt



Combination Deadbolt

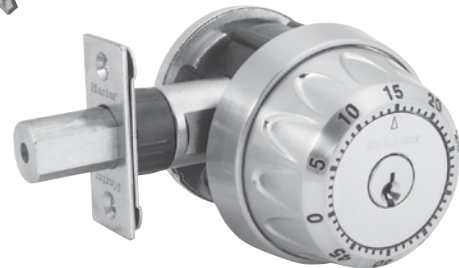

NightWatch Combination Deadbolt

For those who prefer the convenience of keyless entry, NightWatch is available in the industry's **First Dial Combination Deadbolt for Residential Application.**

- Operates like any 3 digit dial combination lock.
- Combines the keyed entry security of a deadbolt with the keyless flexibility of a safe lock.
 - Combination may be reset by a qualified locksmith
- Provides combination backup for those who prefer keyed access for daily use.
- Fits standard BHMA deadbolt door prep.
- When engaged, 100% Bump Proof
 - Incorporates BUMP cylinder technology
- Replaces any standard residential deadbolt
- Exclusively from Master Lock

NightWatch Combination Deadbolts, Box pack

Order #	Item #	Finish	Catalog Price
555-3045	DSNRN1003	Bright Brass	\$68.22
555-3050	DSNRN1005	Antique Brass	68.74
555-3055	DSNRN1015	Satin Nickel	74.64

PAPAIZ

Narrow Stile Locks

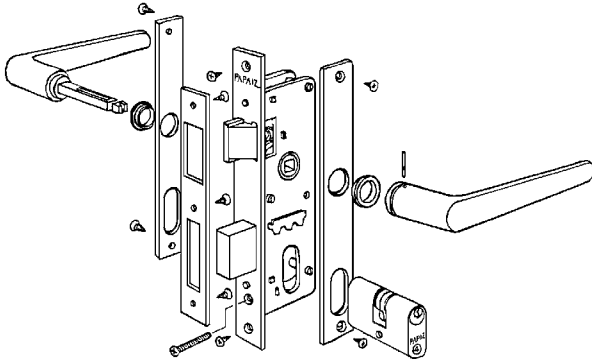

SLIMLINE Mortise Lock

Complete Lever lockset, double cylinder.
 Solid Brass face plate and escutcheon plates.
 Double latch deadbolt with 5/8" throw.
 Five pin Keyed Cylinder with 2 keys.
 Bright Brass Finish. Catalog Price: **\$93.34**

Order #	Item #
648-0005	323 C-400/55 E-23 MZ-35 LT

**Replacement
Cylinders**

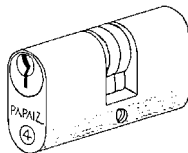

Double Keyed replacement cylinder
 Solid brass construction. Five pins, Satin Brass. For use as replacement for the Papaiz locksets Ref. #815, #323 and Deadbolt #321.

Order #	Item #	Catalog Price
648-0400	C-400/55AC	\$46.66

Papaiz Key Blanks

2-F blanks substitutes 3-C blanks

Order #	Item #	Ea
648-0002	2-F	\$2.16

SARGENT®

A Revolutionary
Grade 1
Lockset



T-Zone™ Lever Lockset

The Sargent T-Zone sets a higher standard for Grade 1 bored-in locks. The unique, T-Zone construction provides unequalled strength and durability for the most demanding applications such as schools and hospitals. This is accomplished by true interlocking between the lockbody and the latchbolt. Sargent has developed the interlocking aligning and latch tubes, which form a rugged torque resistant "T" in the critical twist area. This "T-Zone" construction, combined with long lasting components, makes T-Zone Lever Locks outstanding.

- Exceeds 2400 in. lbs. of torque resistance - nearly 2.5 times ANSI/BHMA A156.2 Grade 1 requirements (1,000 in. lbs.)
- Eliminates lever sag even after 2 million cycles.
- Not handed, field reversible
- Fits on minimum stiles 4-1/4" and 4-1/2"
- Torque values greatly increased by a stainless steel bearing providing stops for a heat treated locking piece
- Meets Buy America Act
- Seven year limited SARGENT warranty
- 2-3/4" Backset, for 1-3/4" (44mm) thick door adjustable to 2".

Meets ANSI A156.2 Series 4000 Grade 1; UL and UL listed to Canadian safety standards; Meets UL 10C and UBC 72 (1997); Complies with Buy American Act.

Order #	Item #	Description	Cat. Price
730-3015	11U15 LL 26D	Passage	\$408.00
730-3065	11U65 LL 26D	Privacy	477.60
730-3005	11G05 LL 26D	Entry	536.40
730-3004	11G04 LL 26D	Storeroom	536.40
730-3037	11G37 LL 26D	Classroom	536.40

SARGENT®

480-Line

AUXILIARY LOCKS



Meets
ANSI A156.5

Grade 1 requirements.

For doors

1-3/8" to

1-3/4" thick.

2-3/4" Backset fits 161 cutout.

BOLT: 7/8" x 5/8" x 1" throw. Hardened steel pin.



480 Line Cylindrical Deadbolt

KD, LA Keyway, 0-Bitted, 2-3/4" Backset, ANSI Strike

Order #	Item #	Function	Price
730-2110	484 US26D	Double Cylinder	\$214.80
730-2115	485 US26D	Single Cylinder	160.80

SARGENT 6500-Line

Grade 2

BORED LEVER Locksets

28-6500 LINE, KD, LA Keyway, 0-Bitted

Order #	Item #	Function	Cat. Price
730-1100	28-65U15 KL US26D	Passage	\$162.00
730-2090	28-65G65 KL US26D	Bathroom	176.40
730-1105	28-65G05 KL US26D	Office	252.00
730-1106	28-65G05 KL 10B	Office	252.00
730-2071	28-65G04 KL 10B	Storeroom	252.00
730-2070	28-65G04 KL US26D	Storeroom	252.00
730-2085	28-65G37 KL US26D	Classroom	252.00

SARGENT LOCK FUNCTIONS:

- 04 Storeroom • Guard bolt deadlocks latchbolt.
 - Latchbolt retracted by lever inside or key outside.
 - Outside lever rigid at all times.
- 05 Office • Guard bolt deadlocks latchbolt.
 - Latch bolt retracted by either lever unless outside lever is locked by toggle in lock front.
 - Key outside retracts latch bolt when outside lever is locked.
- 15 Passage • Latch bolt retracted by either lever.
- 37 Classroom Lock • Guard bolt deadlocks latch bolt.
 - Latch bolt retracted by either lever unless outside lever is locked by key outside.
 - Key outside locks or unlocks outside lever.
 - Inside lever always operative.
- 65 Bathroom Lock • Latchbolt retracted by either lever
 - Turn lever automatically locks outside lever
 - Operating inside lever automatically retracts latch bolt unlocking outside lever
 - Outside emergency release unlocks outside lever.

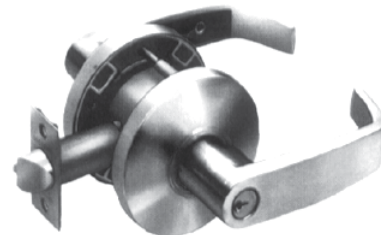

Standard duty key-in-lever lockset designed to exceed the requirements of ANSI A156.2, Series 4000, Grade 2. Doors 1-3/8" to 1-3/4". 2-3/4" Backset. Non-handed. UL Listed for use on fire doors, UL-F 78E5.

SARGENT®

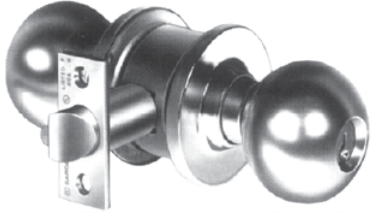

Highly styled standard duty lock line, built to conform to Federal Specification Series 160. It is ideally suited for fine homes, motels, apartment houses and small commercial buildings.

Made to last and boasts many quality features. Completely reversible either before or after installation. Conforms to ANSI A156.2, Series 4000, Grade 2.

SARGENT 6-Line Grade 2 Locksets

KD, LA Keyway, 0-Bitted,
ANSI A115.2 Strike, 2-3/4" Backset.
For doors 1-3/8" to 1-3/4". 2-3/4" Backset. Non-handed.

Order #	Item #	Function	Cat. Price
730-2100	24-28-6U15 OB US26D	Passage	\$134.40
730-2105	24-28-6U65 OB US26D	Bathroom	153.60
730-2095	24-28-6G05 OB US26D	Office	208.80
730-2096	24-28 6G05 OB 10B	Office	213.60
730-2107	24-28 6G04 OB 26D	Storeroom	208.80
730-2106	24-28 6G04 OB 10B	Storeroom	213.60
730-2102	24-28 6G37 OB 26D	Classroom	208.80

SARGENT 8-Line Grade 1 Locksets



Heavy Duty Knob lock

Certified under ANSI A156.2 Series 4000 for Grade 1.
Affords great strength & security, quiet operation, and long life

KD, LA Keyway, 0-Bitted,
ANSI A115.2 Strike, 2-3/4" Backset.
For doors 1-3/8" to 1-3/4". Non-handed.

Order #	Item #	Function	Cat. Price
730-3800	28-8G04 OB US26D	Storeroom	\$454.80
730-3805	8G05 OB US26D	Entry	556.80
730-3810	8G37 OB US26D	Classroom	556.80

- Guarded latch bolt
- Latch tube interlocks with aligning tube in critical "T-Zone"
- Hard drawn seamless brass latch tube
- Locking plate fully supported for true alignment with latch unit
- Stainless steel springs and retractors

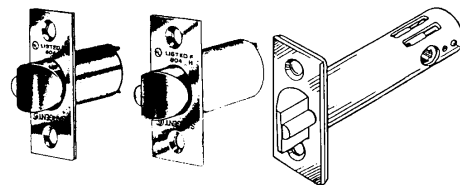

Standard 6-Line Latchbolt

2-1/4" x 1" Front. US26D.

Order #	Item #	Backset	Price
730-5083	06-5083	2-3/8"	\$41.28
730-5094	06-5094	2-3/4"	41.28

8-Line Latchbolt. US26D

730-2510	08-2510	2-3/4"	\$110.36
----------	---------	--------	-----------------

SARGENT 10-Line Locksets

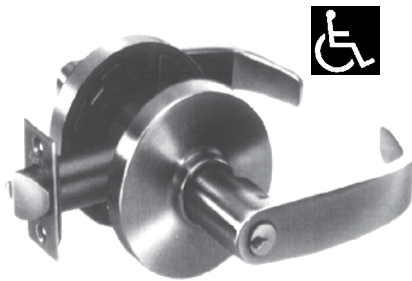

Heavy duty cylindrical key-in-lever handle lockset designed to exceed the requirements of ANSI 156.2, Series Grade 1.

Conforms to national and state fire and handicapped requirements. 2-3/4" Backset; For doors 1-3/4" thick. Non-handed.

BORED LEVER LOCKSETS

10 LINE, KD, LA Keyway, 0-Bitted, 28:
ANSI A115.2 Strike

Order #	Item #	Function	Price
730-2045	28-10G04 LL US26D	Storeroom	\$475.20
730-1005	28-10G05 LL US26D	Office	494.40
730-2055	28-10U15 LL US26D	Passage	348.00
730-1017	28-10G37 LL US26D	Classroom	475.20
730-2065	28-10U65 LL US26D	Bathroom	400.80

10 Series Classroom lock, Less Cylinder

Order #	Item #	Cat. Price
730-1018	28-10G37-LL-US26D	\$416.40



With Removable Disposable Construction Core:

730-1010	60-10G05-LL-26D	\$475.20
730-1015	60-10G04-LL-26D	\$475.20

BORED Lever Locksets

SG- Same as standard 10 Series features, but these have **MICROSHIELD** - Antimicrobial Powder Coat

Order #	Item #	Function	Cat. Price
730-2155	SG-10U15 LL US26D	Passage	\$348.00
730-2165	SG-10U65 LL US26D	Bathroom	400.80
730-2135	SG-10U05 LL US26D	Entry	494.40
730-2145	SG-10G04 LL US26D	Storeroom	475.20

SARGENT MORTISE LOCKSET

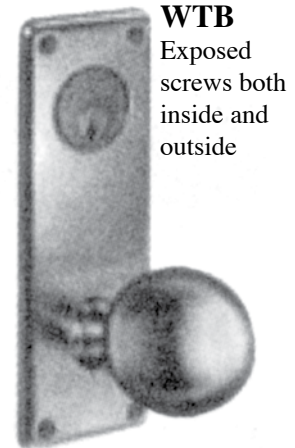
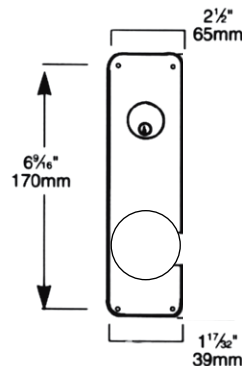

WTB

Exposed screws both inside and outside

SARGENT 7800 LINE

For Doors: 1-3/4" thick standard, 2-3/4" backset.

Armored front: 8"x1-1/4", ANSI Standard A115.1.

Latchbolt: Stainless steel 3/4" one-piece, anti-friction reversible latchbolt. Meets all performance dimensional specs of ANSI A156 13 1000 Grade 1.

Deadbolt: Stainless steel, 1" throw with hardened steel rollers.

Strike: ANSI Standard A115.1; curved lip, non-handed

• Handed, but handing is reversible in field. LA Keyway.

FUNCTION: Storeroom. Latchbolt by either lever. Deadbolt operated from outside by key, inside by turn lever. When deadbolt is projected, outside lever is automatically locked. ANSI F21.

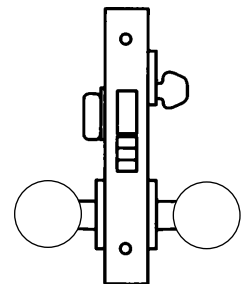

Order #	Item-Knob-Finish-Handing	Price
730-1020	(U) 7824-WTB-US26D LH	\$793.20
730-1030	(U) 7824-WTB-US26D RH	793.20

Let us Quote Your Next Big Job.

We can special order the items you need at very competitive prices. Call your customer service rep today for pricing and delivery on all items not listed in our catalog. Thanks for your continued patronage!

Single Cylinder without Deadbolt

7800/8200 Mortise Lock Functions

*±04 Storeroom or Closet

8204, 7804

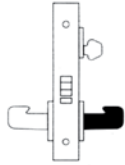

- Key outside or lever/knob inside retracts latchbolt
- Lever/Knob outside rigid at all times
- Lever/Knob inside retracts latchbolt
- Auxiliary deadlatch
- A Multi-Function Lock Body
- ANSI F07

*05 Office or Entry

8205, 7805

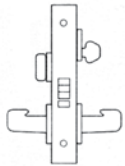

- Key outside retracts latchbolt when outside lever/knob is locked
- Lever/Knob inside retracts latchbolt only, outside Lever/Knob remains locked
- Lever/Knob outside is locked/unlocked by thumb turn inside or by key outside
- Auxiliary deadlatch
- A Multi-Function Lock Body
- ANSI F04

The Multi-Function Advantages with Rose Trim:

- (1) This lock will accommodate 04, 05 & 37 Functions without additional parts.
- (2) By adding an additional Cylinder, this lock will accommodate 17 & 38 Functions.
- (3) By adding a Trim One Side Kit, this lock will accommodate 06, 13, 31 & 36 Functions.

Note: Office/Entry Function with toggle is available— order as a 55 function.

06 Storeroom or Service

8206, 7806

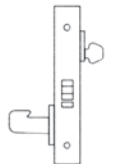

- No outside lever/knob, cylinder only
- Lever/Knob inside or key outside retracts latchbolt
- Auxiliary deadlatch
- Same as 04 Function without lever/knob outside
- A Multi-Function Lock Body

±31 Utility

8231, 7831

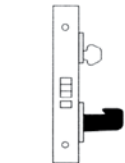

- Key outside retracts latchbolt
- Lever/Knob outside is always rigid
- Inside: no lever/knob or cylinder
- A Multi-Function Lock Body
- Auxiliary deadlatch

*8200 Available with Freewheeling Trim

±7800 Available with Push/Pull Trim

±CAUTION: Not recommended for use on any door used for Life Safety egress



If shaded, knob or lever rigid at all times

*±36 Closet

8236, 7836

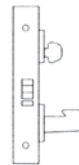

- Key outside locks and unlocks outside lever/knob
- Lever/Knob outside retracts latchbolt, except when locked
- Inside: no lever/knob or cylinder
- A Multi-Function Lock Body
- Auxiliary deadlatch

*±37 Classroom

8237, 7837

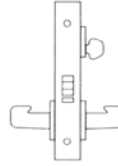

- Key outside locks and unlocks lever/knob outside
- Key outside retracts latchbolt
- Lever/Knob outside retracts latchbolt, except when outside lever/knob is locked by key
- Lever/Knob inside always retracts latchbolt
- Auxiliary deadlatch
- A Multi-Function Lock Body
- ANSI F05

55 Office or Entry

8255, 7855

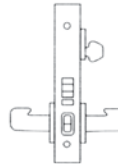

- Key outside retracts latchbolt when outside lever/knob is locked
- Lever/Knob inside retracts latchbolt only, outside Lever/Knob remains locked
- Lever/Knob outside is locked by toggle only
- Auxiliary deadlatch

56 Office & Inner Entry Lock

8256, 7856

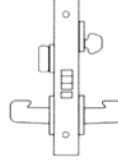

- Key outside retracts latchbolt when outside lever/knob is locked
- Lever/Knob inside retracts latchbolt and unlocks outside lever/knob
- Lever/Knob outside is locked by thumb turn or key
- Auxiliary deadlatch

67 Institutional Privacy

8267, 7867

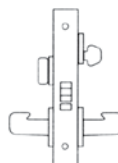

- Key outside retracts latchbolt, with override of turn inside when held in locked position
- Lever/Knob outside retracts latchbolt except when locked by thumb turn or key outside
- Lever/Knob outside unlocks when the door closes or operating lever/knob inside
- Lever/Knob inside always retracts latchbolt
- Auxiliary deadlatch
- ANSI F26

ASSA ABLOY

SARGENT® 7800/8200 Mortise Lock Functions

89 Holdback

8289

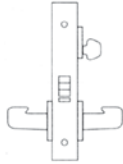

- Key outside retracts latchbolt when lever/knob outside is locked
- Lever/Knob outside retracts latchbolt, unless locked by key outside
- Latchbolt can be locked into retracted position by the key
- Lever/Knob inside is always active
- Auxiliary deadlatch

91 All Purpose Holdback

8291



- Key outside retracts latchbolt
- Key outside can lock latchbolt in retracted position
- Lever/Knob inside retracts latchbolt
- There is no outside lever or knob
- Auxiliary deadlatch

Single Cylinder with Deadbolt

±24 Storeroom Door

8224, 7824

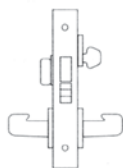

- Key outside or thumb turn inside retracts and projects deadbolt
- Lever/Knob either side retracts latchbolt
- Latchbolt and deadbolt are independent of each other
- ANSI F21

*25 Dormitory or Exit

8225, 7825

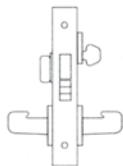

- Key outside or thumb turn inside retracts and projects deadbolt
- Lever/Knob from either side retracts latchbolt, when the deadbolt is in the retracted position
- Lever/Knob outside is locked, when the deadbolt is projected
- When deadbolt is projected, lever/knob inside retracts latchbolt and deadbolt simultaneously, unlocking outside lever/knob
- ANSI F13

+27 Closet or Storeroom

8227, 7827

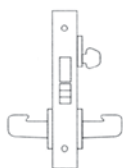

- Key outside retracts and projects deadbolt
- Lever/Knob from either side retracts latchbolt
- Same as 24 function without thumb turn
- Latchbolt and deadbolt are independent of each other

28 Dummy Trim Deadlock

8228, 7828

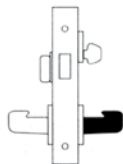

- Deadbolt operation only
- Key outside retracts and projects deadbolt
- Lever/Knob inside retracts deadbolt
- Lever/Knob outside is always rigid
- Thumb turn inside retracts and projects deadbolt

30 Dummy Trim Deadlock

8230, 7830

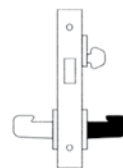

- Deadbolt operation only
- Key outside retracts and projects deadbolt
- Lever/Knob inside retracts deadbolt
- Lever/Knob outside is always rigid
- Same as 28 Function without a thumb turn

±35 Storeroom

8235, 7835

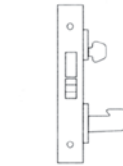

- Key outside retracts and projects deadbolt
- Lever/Knob outside retracts latchbolt, except when deadbolt is projected
- Inside: no lever/knob or cylinder

±43 Apartment Corridor Door

8243, 7843

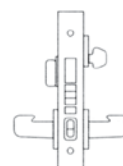

- Key outside or thumb turn inside retracts and projects deadbolt
- Key outside retracts both latchbolt and deadbolt, lever/knob outside remains locked
- Lever/Knob from either side retracts latchbolt, except when lever/knob outside is locked
- Lever/Knob outside is locked by toggle or projecting deadbolt
- Lever/Knob outside is unlocked by toggle only
- Lever/Knob inside (when deadbolt is projected) retracts latchbolt and deadbolt simultaneously, and lever/knob outside remains locked
- Auxiliary deadlatch
- ANSI F20

*8200 Available with Freewheeling Trim

±7800 Available with Push/Pull Trim

⚠CAUTION: Not recommended for use on any door used for Life Safety egress



If shaded, knob or lever rigid at all times

ASSA ABLOY

‡45 Dormitory or Exit

8245, 7845

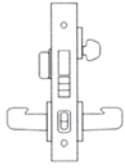

- Key outside or thumb turn inside retracts and projects deadbolt
- Key outside retracts both latchbolt and deadbolt, lever/knob outside remains locked
- Lever/Knob from either side retracts latchbolt, except when lever/knob outside is locked
- Lever/Knob outside is locked by toggle or projecting deadbolt
- Lever/Knob inside (when deadbolt is projected) retracts latchbolt and deadbolt simultaneously, and lever/knob outside remains locked
- Same as 43 function without auxiliary deadlatch
- ANSI F12

‡47 Front Door or Apartment Corridor Door

8247, 7847

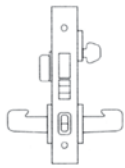

- Key outside or thumb turn retracts and projects deadbolt
- Key outside operates both latchbolt and deadbolt
- Lever/Knob from either side retracts latchbolt, except when lever/knob outside is locked
- Lever/Knob outside is locked by toggle or projecting deadbolt
- Lever/Knob outside is unlocked by toggle only
- Lever/Knob inside (when deadbolt is projected) retracts latchbolt only, deadbolt remains projected and outside lever/knob remains locked
- ANSI F08/F10

*‡ 50 Hotel Guest

8250, 7850

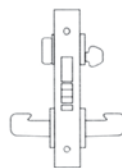

- Hotel Cylinder Required (50 Function Cylinder) with two types of Keys (Standard & Emergency)
- Standard Key outside retracts latchbolt only, will not retract or project deadbolt
- Emergency Key outside will retract latchbolt and deadbolt and also project deadbolt
- Thumb turn inside retracts and projects deadbolt
- When the deadbolt is projected, it shuts out all keys except the emergency key
- Lever/Knob inside retracts both latchbolt and deadbolt simultaneously
- Lever/Knob outside is always rigid
- Auxiliary deadlatch
- Not available with certain key systems
- ANSI F15

*51 Storeroom Deadbolt

8251, 7851

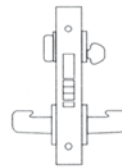

- Key outside will retract latchbolt and deadbolt and also project deadbolt
- Lever/Knob inside retracts both latchbolt and deadbolt simultaneously
- Lever/Knob outside is always rigid
- Thumb turn inside retracts and projects deadbolt
- Auxiliary deadlatch
- Same as 50 function with a standard cylinder

SARGENT®

Double Cylinder without Deadbolt

*‡16 Apartment, Exit or Public Restroom

8216, 7816

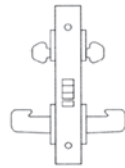

- Key outside retracts latchbolt, when outside lever/knob is locked
- Key inside is required to lock and unlock lever/knob outside
- Lever/Knob either side retracts latchbolt, unless outside lever/knob is locked by key inside
- Lever/Knob inside always operable
- Auxiliary deadlatch
- Special cam required for inside cylinder
- ANSI F09

*8200 Available with Freewheeling Trim

‡7800 Available with Push/Pull Trim

‡CAUTION: Not recommended for use on any door used for Life Safety egress



If shaded, knob or lever rigid at all times

ASSA ABLOY

*‡*17 Asylum or Institutional

8217, 7817

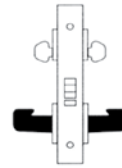

- Key from either side retracts latchbolt
- Lever/Knob on both sides rigid at all times
- Auxiliary deadlatch
- A Multi-Function Lock Body
- ANSI F30

*38 Classroom Security Intruder Latchbolt

8238, 7838

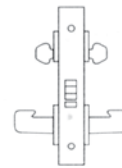

- Key from either side locks and unlocks lever/knob outside
- Key from either side retracts latchbolt
- Lever/Knob outside retracts latchbolt, except when outside lever/knob is locked by key
- Lever/Knob inside always retracts latchbolt
- Auxiliary deadlatch
- Same as 37 function with two cylinders
- A Multi-Function Lock Body
- ANSI F32

SARGENT®**90 Classroom Security Holdback**

8290

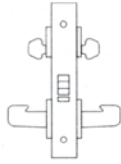

- Key either side retracts latchbolt when lever/knob outside is locked
- Lever/Knob outside retracts latchbolt, unless locked by key from either side
- Latchbolt can be locked into retracted position by the key from either side
- Lever/Knob inside is always active
- Auxiliary deadlatch
- Same as 89 function with two cylinders

92 All Purpose Holdback

8292, 7892



- Key outside retracts latchbolt
- Key inside can lock latchbolt in retracted position
- Lever/Knob inside retracts latchbolt
- There is no outside lever or knob
- Auxiliary deadlatch
- 7892 "T" turn is used in place of knob
- Special cam required for inside cylinder

Double Cylinder with Deadbolt****‡26 Store Door**

8226, 7826

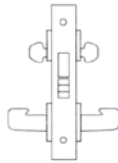

- Key from either side retracts and projects deadbolt
- Lever/Knob from either side retracts latchbolt
- Latchbolt and deadbolt are independent of each other
- Same as 24 Function with two cylinder and no thumb turn
- **ANSI F14**

29 Dummy Trim Deadlock

8229, 7829

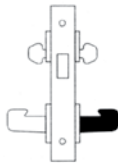

- Deadbolt operation only
- Key on either side retracts and projects deadbolt
- Lever/Knob inside retracts deadbolt
- Lever/Knob outside is always rigid
- Same as 28 Function with a cylinder in place of thumb turn

***39 Classroom Security Intruder Deadbolt**

8239, 7839

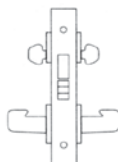

- Key either side retracts or projects deadbolt to unlock or lock lever/knob outside
- Lever/Knob outside retracts latchbolt, except when outside lever/knob is locked by key
- Lever/Knob inside retracts both latchbolt and deadbolt simultaneously, and unlocks lever/knob outside
- Same as 25 function with a cylinder inside in place of thumb turn
- **ANSI F33**

***40 Classroom Security Intruder Deadbolt**

8240, 7840

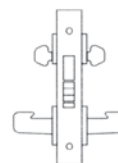

- Key either side retracts or projects deadbolt to unlock or lock lever/knob outside
- Lever/Knob outside retracts latchbolt, except when outside lever/knob is locked by key
- Lever/Knob inside retracts both latchbolt and deadbolt simultaneously, and unlocks lever/knob outside
- Auxiliary deadlatch
- Same as 39 function with Auxiliary deadlatch

41 Classroom Security

8241, 7841

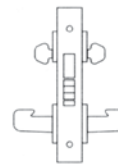

- Key from either side retracts and projects deadbolt
- Key retraction of deadbolt, lever/knob outside remains locked
- Key retraction of latchbolt from either side unlocks lever/knob outside
- Lever/Knob outside retracts latchbolt, except when outside lever/knob is locked by key
- Lever/Knob outside is locked when the deadbolt is projected
- Lever/Knob inside (when deadbolt is projected) retracts both latchbolt and deadbolt simultaneously, and lever/knob outside remains locked
- Auxiliary deadlatch

46 Dormitory or Exit

8246, 7846

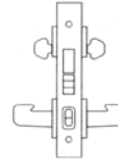

- Key from either side retracts and projects deadbolt
- Key from either side retracts both latchbolt and deadbolt, lever/knob outside remains locked
- Lever/Knob from either side retracts latchbolt, except when lever/knob outside is locked
- Lever/Knob outside is locked by toggle or projecting deadbolt
- Lever/Knob outside is unlocked by toggle only
- Lever/Knob inside (when deadbolt is projected) retracts latchbolt and deadbolt simultaneously, and outside lever/knob remains locked
- Same as 45 function with a cylinder in place of thumb turn

*8200 Available with Freewheeling Trim

‡7800 Available with Push/Pull Trim

♦**CAUTION:** Not recommended for use on any door used for Life Safety egress

If shaded, knob or lever rigid at all times

ASSA ABLOY

†48 Store Door

8248, 7848

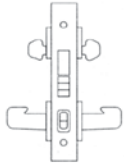

- Key from either side retracts and projects deadbolt
- Key from either side retracts latchbolt
- Lever/Knob from either side retracts latchbolt, except when lever/knob outside is locked
- Lever/Knob outside is locked by toggle or projecting deadbolt
- Lever/Knob outside is unlocked by toggle only
- Lever/Knob inside (when deadbolt is projected) retracts latchbolt only, deadbolt remains projected and outside lever/knob remains locked
- Same as 47 function with a cylinder inside and no thumb turn
- ANSI F25

†52 Institutional Deadbolt

8252, 7852

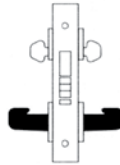

- Key from either side retract latchbolt
- Key from either side retracts and projects deadbolt
- Lever/Knob on both sides are always rigid
- Auxiliary deadlatch

SARGENT®

Non-Keyed

13 Exit Latch

8213, 7813



- No outside lever/knob or cylinder
- Lever/Knob inside retracts latchbolt
- Auxiliary deadlatch
- A Multi-Function Lock Body
- ANSI F31

‡15 Passage or Closet

8215, 7815

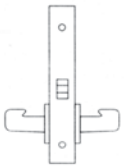

- Lever/Knob from either side retracts latchbolt at all times
- ANSI F01

*‡ 65 Privacy Bedroom or Bath

8265, 7865

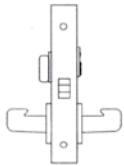

- Lever/Knob outside retracts latchbolt except when locked by thumb turn inside
- Lever/Knob inside retracts latchbolt and unlocks outside lever/knob
- Emergency Release unlocks lever/knob outside
- Thumb turn locks and unlocks lever/knob outside
- Closing the door will unlock lever/knob outside
- ANSI F22

*66 Privacy Bedroom or Bath

8266, 7866

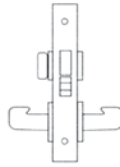

- Lever/Knob outside retracts latchbolt except when deadbolt is projected
- Lever/Knob inside retracts both latchbolt and deadbolt simultaneously, and unlocks outside lever/knob
- Emergency Release retracts and projects deadbolt
- Thumb turn retracts and projects deadbolt
- ANSI F19

†68 Privacy Bedroom or Bath

8268, 7868

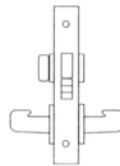

- Lever/Knob from either side retracts latchbolt at all times
- Thumb turn inside retracts and projects deadbolt
- Emergency release outside retracts and projects deadbolt
- Latchbolt and deadbolt are independent of each other
- ANSI F02

93 Trim Dummy

8293, 7893

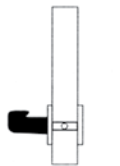

- Lever/Knob on one side only is always rigid
- Lever/Knob only used as door pull

*8200 Available with Freewheeling Trim

‡7800 Available with Push/Pull Trim

†CAUTION: Not recommended for use on any door used for Life Safety egress

ASSA ABLOY



If shaded, knob or lever rigid at all times

DOOR LOCKS

SARGENT®
ASSA ABLOY

8200 Mortise Locks

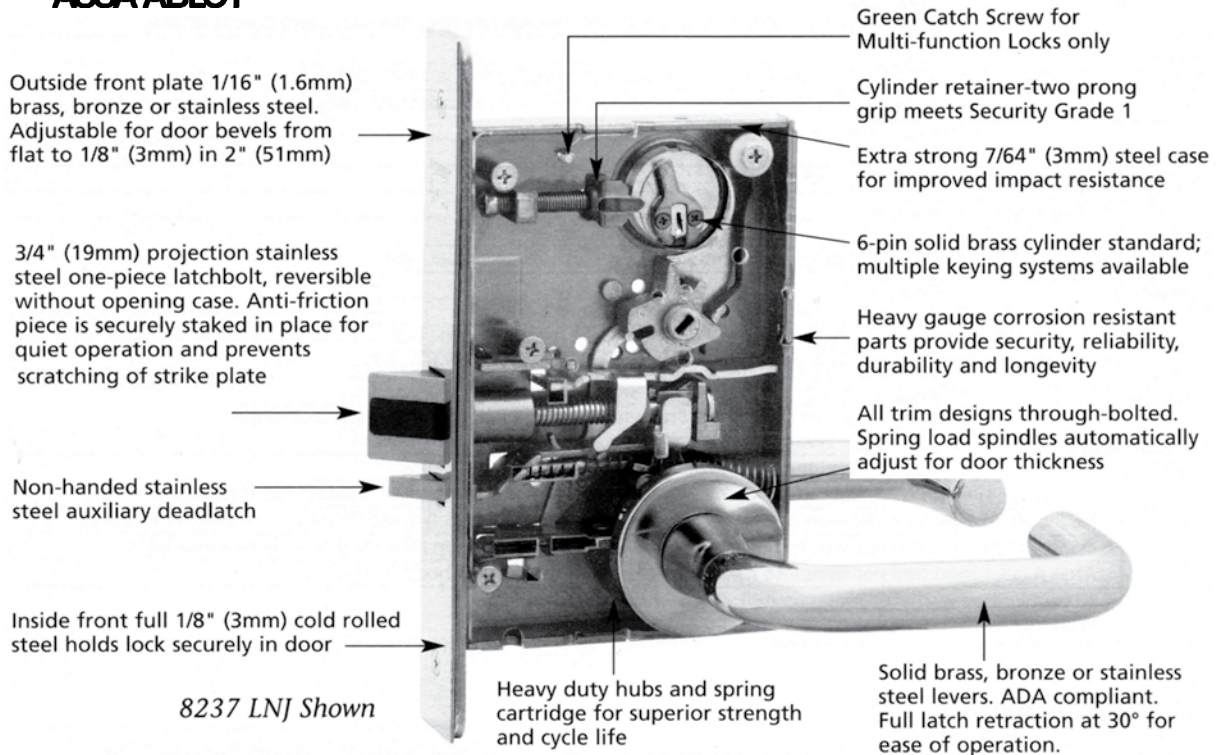

Maximum Strength & Durability

- Exceeds ANSI A156.13, Series 1000, Operational Grade 1 and Security Grade 1 with standard trims.
- Meets and exceeds ASTM F1577-95b paragraph 6.2 detention impact level 1 for deadbolt functions, level 3 for latch only functions.
- 12 gauge (.109) steel case and cap
- 3/4" stainless steel latchbolt, one-piece construction
- 2-3/4" backset, for 1/3/4" thick doors.
- 10 year manufacturer's mechanical warranty. No service required to maintain warranty.

Maximum Flexibility

- Fast and easy installation. Easily re-handed without removing parts or opening the lock case.
- Multi-function lockbody makes it easy to change functions in the field.

- UL Listed for use on fire doors up to 4'x10' and double door applications.

Innovation

- First in the industry to offer a multi-functional lock that embodies 9 functions in 1 lock body.
- Easy operation, Only 30° of lever rotation required to retract latchbolt.
- Lever springs contained inside of the lock case for easier installation.
- Unique spring design, provides longer lock life, no lever sag, and simple installation.
- Torx and spanner screws

Next page for ordering information.

SARGENT®

ASSA ABLOY

DOOR LOCKS

8200 Mortise Locks



Multi-Function Lock Body

- (1) Lock will accommodate 04, 05, & 37 Functions without additional parts.
- (2) By adding an additional cylinder, lock will accommodate 17 & 38 functions.
- (3) By adding a Trim One Side Kit, lock will accommodate 06, 13, 31, & 36 functions.

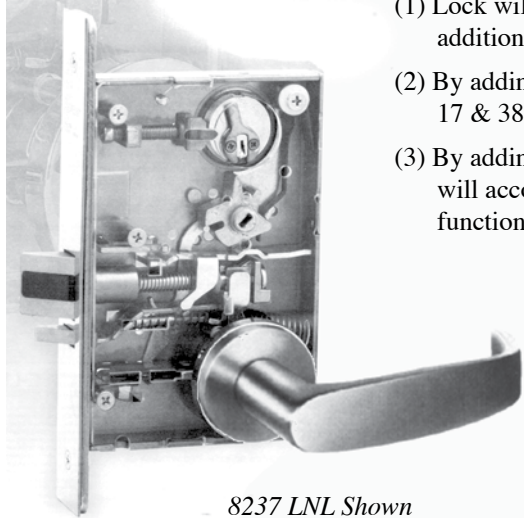

8237 LNL Shown



WTL



LNB



LNL



LNJ

Mortise Locks

Body Only with Front and Strike.

Non-Handed, Satin Chrome.

Order Trim Separately

CYLINDERS NOT INCLUDED

Order #	Item	Function	Catalog Price
730-2200	BP-8204 26D	Storeroom	\$285.60
730-2205	BP-8205 26D	Office	285.60
730-2210	BP-8237 26D	Classroom	285.60
730-2215	BP-8255 26D	Office	285.60
730-2220	BP-8224 26D	Storeroom w/Deadbolt	303.60
730-2225	BP-8225 26D	Dormitory w/Deadbolt	303.60
730-2230	BP-8215 26D	Passage	238.80
730-2235	BP-8265 26D	Privacy	270.00

A Complete lock consists of a
BODY, TRIM PACKAGE,
 and Cylinder(s) (order separately)

Trim Package

Includes all fasteners. Satin Chrome

Order Lock Body Separately

Order #	Item	For Functions	Cat. Price
730-3200	TR-8204 LNB 26D	8204, 8205 8237, 8255	\$350.40
730-3205	TR-8204 LNL 26D	8204, 8205 8237, 8255	350.40
730-3210	TR-8204 LNJ 26D	8204, 8205 8237, 8255	241.20
730-3215	TR-8224 LNB 26D	8224, 8225 8243, 8245	367.20
730-3220	TR-8224 LNL 26D	8224, 8225 8243, 8245	367.20
730-3225	TR-8224 LNJ 26D	8224, 8225 8243, 8245	258.00
730-3230	TR-8215 LNL 26D	8215	343.20
730-3235	TR-8215 LNL 26D	8265	385.20

WTL Escutcheon w/levers

Order #	Item	Function	Cat. Price
730-3240	TR-8204 WTL 26D	Single Cyl. Storeroom/Closet	\$350.40
730-3245	TR-8215 WTL 26D	Non Keyed Passage or Closet	343.20



AL-Series Standard Duty Keyed Levers

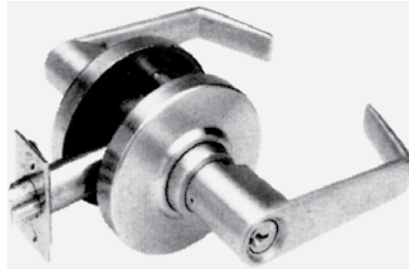

Engineered with performance as the ultimate goal . . . and no compromises. These Grade 2 locksets are loaded with superior parts. For starters, there is the stainless steel,

interlocking spindle that provides extra strength when excess force is applied to the lever in the locked position.

Added to that are the threaded hubs and castle nuts, which literally bolt the chassis to the door to prevent loosening. Schlage has chosen compression springs for the heavy-duty spring cages, which provide consistent lever return. And the "true" through-bolting, outside the 2-1/8" through bore preparation, prevents the chassis from rotating. This keeps the latch from disengaging, which can result in lock-ins/outs.

And finally, Schlage has utilized their classic, machine extruded brass cylinder with nickel silver pins and keys for the greatest wear resistance and smooth operation.

Call for Quantity Price Breaks.



NEPTUNE

Symbol: NEP
Material: Pressure cast zinc lever; wrought brass or bronze rose.

2-3/4" backset, 10-025 strike
Classic "C" Keyway

Order #	Item #	Function	Catalog Price
740-8000	(U) AL10S NEP 612	Passage	\$231.60
740-8003	(U) AL10S NEP 625	Passage	231.60
740-8001	(U) AL40S NEP 612	Privacy	260.40
740-8004	(U) AL40S NEP 625	Privacy	260.40
740-8002	(U) AL53PD NEP 612	Entry	331.20
740-8005	AL53PD NEP 625	Entry	331.20

Classic "C" Keyway. "LD" LESS CYLINDER

2-3/4" Backset:

Order No.	Item No.	function	Each
740-8015	AL10S SAT 605	passage	\$231.60
740-8011	AL10S SAT 613	passage	231.60
740-8010	AL10S SAT 626	passage	217.20
740-8045	AL40S SAT 605	privacy	260.40
740-8041	AL40S SAT 613	privacy	260.40
740-8040	AL40S SAT 626	privacy	246.00
740-8055	AL53LD SAT 605	entry	274.80
740-8051	AL53LD SAT 613	entry	274.80
740-8053	AL53PD SAT 626	entry	316.80
740-8054	AL53LD SAT 626	entry	260.40
740-8070	AL70PD SAT 626	classroom	316.80
740-8074	AL70LD SAT 626	classroom	260.40
740-8085	AL80LD SAT 605	storeroom	274.80
740-8081	AL80LD SAT 613	storeroom	274.80
740-8080	AL80PD SAT 626	storeroom	316.80
740-8084	AL80LD SAT 626	storeroom	260.40

2-3/8" Backset:

Classic "C" Keyway

Order No.	Item No.	function	Each
740-8012	AL10S SAT 626	passage	\$217.20
740-8042	AL40S SAT 626	privacy	246.00
740-6010	AL50LD SAT 626	entry	260.40
740-8052	AL53PD SAT 626	entry	316.80
740-8082	AL80LD SAT 626	storeroom	260.40

"A" Series Heavy Residential & Standard Duty Commercial Buildings

Certifications: U.L. Listed, ANSI A156.2 Series 4000 Grade 2

Keying: 6-pin tumbler, keyed 5

Door Range: 1-3/8" to 1-7/8".

Features: Cylindrical lock housing. Cold rolled steel mechanisms, zinc dichromated for corrosion resistance. Demountable outside knobs for easy cylinder replacement. No exposed mounting screws.

Strikes: Square corner, 1-1/8" x 2-3/4" x 3/32" T- strike with 1-1/8" lip, furnished w/dust box.

FINISHES

605: Bright Brass	613: Oil Rubbed Bronze
609: Satin Brass, Blackened	625: Bright Chromium Plated
612: Satin Bronze	626: Satin Chromium Plated

"A" Series

PASSAGE:

ITEM	ORDER # 2-3/8"	ORDER# 2-3/4"	\$
A10S-PLY-605	740-1101	740-1102	\$114.00
A10S-PLY-626	740-1106	740-1107	103.20
A10S-ORB-626	740-1104	740-1105	103.20
A10S-ORB-613	-	740-1111	114.00
A10S-TUL-626	740-1109		126.00
A10S-GEO-609	740-1117		139.20
A10S-ORB-605	740-1118		114.00
A10S-LEV-626	740-4510		169.20

Blank Plate Outside, Inside lever always locked

AL25S SAT 626	-	740-8025	240.00
---------------	---	----------	---------------

PRIVACY:

A40S-PLY-605	740-1401		121.20
A40S-PLY-626	740-1406	740-1407	110.40
A40S-ORB-626	740-1404	740-1405	110.40
A40S-ORB-613	740-1410	740-1411	121.20
A40S-GEO-609	740-1417		147.60
A40S-ORB-605	740-1418		121.20
A40S-LEV-626	740-4515		198.00

ENTRY:

A53PD-PLY-605	740-1501	740-1503	207.60
A53PD-PLY-612	740-1505		207.60
A53PD-PLY-626	740-1510	740-1512	196.80
A53PD-ORB-626	740-1506	740-1508	196.80
A53PD-ORB-613	740-1516	740-1518	207.60
A53PD-ORB-605	740-1528		207.60
A53PD-GEO-605	740-1523		244.80
A53PD-GEO-609	740-1525		244.80

KEYED DIFFERENTLY: w/2-3/4" Backset

A53PD PLY 626 KD 11-096	740-1502	196.80
A53PD PLY 605 KD 11-096	740-1504	207.60

A SERIES ENTRY Less Cylinder:

Item #	Order #	Bolt	Strike	Price
A53LD-PLY-626	740-5000	11-085	10-001	\$140.40
A53LD-PLY-626	740-5004	11-096	10-025	140.40
A53LD-PLY-605	740-5003	11-096	10-001	151.20
A53LD-ORB-605	740-5013	11-096	10-001	151.20
A53LD-ORB-626	740-5010	11-085	10-001	140.40
A53LD-ORB-626	740-5015	11-096	10-001	140.40
A53LD-ORB-613	740-5020	11-085	10-001	151.20
A53LD-ORB-613	740-5025	11-096	10-001	151.20

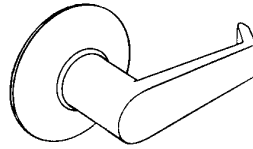

Levon LEV

3-3/16" length
2-9/16" rose
2-1/8" projection

NOTE: "A" Series levers are available on inside only of deadlatch and keyed functions.



"A" Series

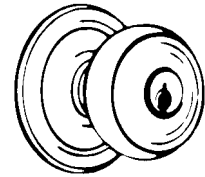

Georgian GEO

2" dia. knob
2-9/16" rose
2-1/4" projection

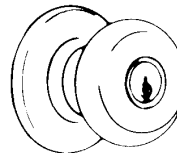

Plymouth PLY

2-1/8" dia. knob
2-9/16" rose
2-5/16" projection

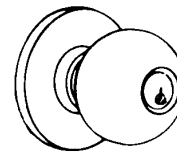

Orbit ORB

2-1/8" dia. knob
2-9/16" rose
2-5/8" projection

CLASSROOM:

ITEM	2-3/8"	2-3/4"	\$
A70PD-PLY-626	740-1710	740-1712	196.80
A70PD-ORB-626	740-1706	740-1708	196.80
A70PD-GEO-609	-	740-1705	244.80

COMMUNICATING:

A79PD-PLY-626	740-1720	-	223.20
---------------	----------	---	---------------

STOREROOM:

A80PD-PLY-605	740-1801		207.60
A80PD-PLY-626	740-1810	740-1812	196.80
A80PD-ORB-626	740-1806	740-1808	196.80
A80PD-ORB-613	740-1816	-	207.60
A80PD-GEO-609	740-1825	-	244.80

"E" KEYWAY:

A80PDE-PLY-626	-	740-1813	196.80
A85PDE-PLY-626	-	740-1863	231.60

CLASSROOM & STOREROOM Less Cylinder:

Item #	Order #	Bolt	Strike	Price
A70LD PLY 626	740-5022	11-085	10-001	\$140.40
A70LD PLY 626	740-5024	11-096	10-025	140.40
A80LD-PLY-626	740-5050	11-085	10-001	140.40
A80LD-ORB-626	740-5055	11-085	10-001	140.40
A80LD-ORB-626	740-1815	11-096	10-001	140.40
A80LD-ORB-613	740-5060	11-085	10-001	151.20



"A" & "D"
Schlage Locksets for
Removeable Core

Schlage Locksets for Full Size Core (not included), 2-3/4" backset

Schlage Locksets for Small Format Core (not included), 2-3/4" backset

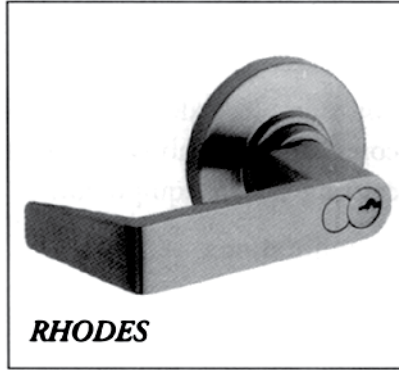

Saturn: SAT
 Rhodes: RHO
 Orbit: ORB

For Small Format Core

Order #	Item #	Price
740-7000	AL53BD SAT 626	316.80
740-7010	AL70BD SAT 626	316.80
740-7020	AL80BD SAT 626	316.80
740-7030	ND53BD RHO 626	494.40
740-7040	ND70BD RHO 626	494.40
740-7073	ND73PD RHO 626	494.40
740-7050	ND80BD RHO 626	494.50

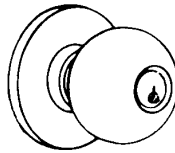

Cylinders not included

For Full Size Core

740-7060	ND53JD RHO 626	465.60
740-7070	ND70JD RHO 626	465.60
740-7080	ND80JD RHO 626	465.60
740-7025	AL53JD SAT 626	288.00
740-7005	A53JD ORB 626	168.00

7-Pin Control Key Blank

740-3056	35-056H	\$4.66
----------	---------	---------------

ND Levers • Functions ANSI A156.2 Series 4000 Grade 1

Non-Keyed Locks

SCHLAGE ANSI
ND10S F75**Passage Latch**
Both levers always unlocked.

ND12D F89

**Exit Lock**
Outside lever always fixed. Inside lever always unlocked.

ND12DEL

**Electrically Locked (Fail Safe)**
Outside lever continuously locked electrically. Unlocked by switch or power failure. Auxiliary latch deadlocks latchbolt when door is closed. Inside lever always free for immediate exit.

ND12DEU

**Electrically Unlocked (Fail Secure)**
Outside lever continuously locked until unlocked by electric current. Auxiliary latch deadlocks latchbolt when door is closed. Inside lever always free for immediate exit.

ND25D

**Exit Lock**
Blank plate outside. Inside lever always unlocked.

ND40S F76

**Bath/Bedroom Privacy Lock**
Push-button locking. Can be opened from outside with small screwdriver. Turning inside lever or closing door releases button.

ND44S

**Hospital Privacy Lock**
Push-button locking. Unlocked from outside by turning emergency turn-button. Turning inside lever or closing door releases button.

ND170

**Single Dummy Trim**
Dummy trim for one side of door. Used for door pull or as matching inactive trim.

Keyed Locks

SCHLAGE ANSI
ND50PD F82**Entrance/Office Lock †**
Push-button locking. Push-button locks outside lever until unlocked with key or by turning inside lever.

ND53PD F109

**Entrance Lock †**
Turn/push-button locking; pushing and turning button locks outside lever, requiring use of key until button is manually unlocked. Push-button locking; pushing button locks outside lever until unlocked by key or by turning inside lever.

ND60PD F88

**Vestibule Lock †**
Latch retracted by key from outside when outside lever is locked by key in inside lever. Inside lever is always unlocked.

ND66PD F91

**Store Lock † ***
Key in either lever locks or unlocks both levers.

ND70PD F84

**Classroom Lock †** 
Outside lever locked and unlocked by key. Inside lever always unlocked.

ND73PD F90

**Corridor Lock †**
Locked or unlocked by key from outside. Push-button locking from inside. Turning inside lever or closing door releases button. When outside lever is locked by key it can only be unlocked by key. Inside lever is always unlocked.

ND75PD

**Classroom Security Lock †** 
Key in either lever locks or unlocks outside lever. Inside lever is always unlocked.

† Keyed functions available with 6-pin (PD/LD), SFIC(GD/BD), or FSIC(RD/JD) cylinder.

*** Caution:** Double cylinder locks on residences and any door in any structure which is used for egress are a life safety hazard in times of emergency and their use is not recommended. Installation should be in accordance with existing codes only.

ND Levers • Functions ANSI A156.2 Series 4000 Grade 1

Non-Keyed Locks

SCHLAGE ANSI

ND80PD F86

**Storeroom Lock †**

Outside lever fixed. Entrance by key only. Inside lever always unlocked.

ND80PDEL

**Electrically Locked (Fail Safe) †**

Outside lever continuously locked electrically. Unlocked by key outside or by switch or power failure. Auxiliary latch deadlocks latchbolt when door is closed. Inside lever always free for immediate exit.

ND80PDEU

**Electrically Unlocked (Fail Secure) †**

Outside lever continuously locked until unlocked by key or electric current. Auxiliary latch deadlocks latchbolt when door is closed. Inside lever always free for immediate exit.

ND82PD F87

**Institution Lock † ***

Both levers fixed. Entrance by key in either lever.

ND85PD

**Faculty Restroom Lock ****

Outside lever fixed. Entrance by key only. Push-button in inside lever activates visual "occupancy" indicator, allowing only emergency master key to operate. Turning inside lever or closing door releases visual occupancy indicator. Rotation of inside spinner-button provides lock-out feature by keeping indicator thrown.



† Keyed functions available with 6-pin (PD/LD), SFIC(GD/BD), or FSIC(RD/JD) cylinders.

* **Caution:** Double cylinder locks on residences and any door in any structure which is used for egress are a life safety hazard in times of emergency and their use is not recommended. Installation should be in accordance with existing codes only.

** 85 function locks are available with 6-pin cylinders only.

SCHLAGE ANSI

ND91PD F82

**Vandlgard Functions****Entrance/Office Lock †**

Push-button locking. Push-button disengages outside lever until unlocked with key or by turning inside lever. Vandlgard is designed to disengage outside spindle from latch when in locked condition.

ND92PD F109

**Entrance Lock †**

Turn/push-button locking; pushing and turning button disengages outside lever, requiring use of key until button is manually unlocked. Push-button locking; pushing button disengages outside lever until unlocked by key or by turning inside lever. Vandlgard is designed to disengage outside spindle from latch when in locked condition.

ND93PD F88

**Vestibule Lock †**

Latch retracted by key from outside when outside lever is disengaged by key in inside lever. Inside lever is always unlocked. Vandlgard is designed to disengage outside spindle from latch when in locked condition.

ND94PD F84

**Classroom Lock †**

Outside lever disengaged and unlocked by key. Inside lever always unlocked. Vandlgard is designed to disengage outside spindle from latch when in locked condition.

ND95PD

**Classroom Security Lock †**

Key in either lever locks or unlocks outside lever. Inside lever is always unlocked.

ND96PD F86

**Storeroom Lock †**

Outside lever always disengaged. Entrance by key only. Inside lever always unlocked. Vandlgard is designed to disengage outside spindle from latch when in locked condition.

ND96PDEL

**Electrically Locked (Fail Safe) †**

Outside lever continuously disengaged electrically. Unlocked by key outside or by switch or power failure. Auxiliary latch deadlocks latchbolt when door is closed. Inside lever always free for immediate exit. Vandlgard is designed to disengage outside spindle from latch when in locked condition.

ND96PDEU

**Electrically Unlocked (Fail Secure) †**

Outside lever continuously disengaged until unlocked by key or electric current. Auxiliary latch deadlocks latchbolt when door is closed. Inside lever always free for immediate exit. Vandlgard is designed to disengage outside spindle from latch when in locked condition.

SCHLAGE "D" Series
Heavy Duty Commercial Locks

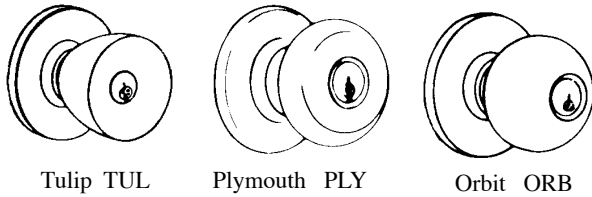

Certifications: ANSI A156.2 Series 4000 Grade 1.
UL Listed.

Keying: 6-pin tumbler, keyed 5.

Door Range: 1-3/8" to 2".

Backset: 2-3/4" Standard.

Features: Cylindrical lock housing. Cold rolled steel mechanisms zinc dichromated for corrosion resistance. Demountable outside knobs, easy cylinder replacement. No exposed mounting screws.

Strikes: Square corner, 1-1/8" x 2-3/4" x 1/8" "T" strike with 1-1/8" lip, furnished with dust box.

"LD": Less Cylinder

"D" SERIES: 2-3/4" Backset, 10-025 Strike

Function	Item	Order #	Cat.Price
Passage	D10S-PLY-626	740-2104	\$366.00
Passage	D10S-ORB-626	740-2103	366.00
Privacy	D40S-PLY-626	740-2404	452.40
Entry	D53PD-PLY-626	740-2505	525.60
Entry	D53PD-ORB-626	740-2503	525.60
Entry	D53PD-ORB-613	740-2509	546.00
Entry	D53LD-PLY-626	740-5100	469.20
Entry	D53LD-ORB-626	740-5120	469.20
Dbl Cyl	D66PD-PLY-626	740-2604	630.00
Classroom	D70LD-PLY-626	740-4509	469.20
Classroom	D70PD-PLY-626	740-2705	525.60
Classroom	D70LD-ORB-626	740-2703	469.20
Dormitory	D73LD-PLY-626	740-2750	469.20
Storeroom	D80LD-PLY-626	740-5105	469.20
Storeroom	D80PD-PLY-626	740-2804	525.60
Institutional	D82PD-PLY-626	740-2824	630.00

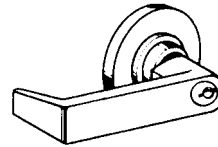

Rhodes: RHO

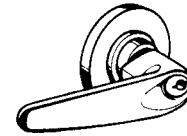
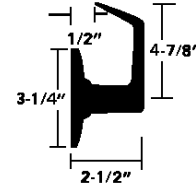

Athens

"ND" Series Leversets

Manufactured to help meet barrier free codes, this ANSI Grade 1 cylindrical lock is designed for easy installation, suitable for new construction or retrofit. Locks are non-handed, featuring thru bolted mounting and external spring cages for independent lever support. 10-025 strike. **"LD": LESS CYLINDER**

Leversets, 2-3/4" Backset. Classic "C" Keyway

Function	ITEM #	ORDER #	PRICE
Passage	ND10S-RHO-626	740-4502	\$361.20
Privacy	ND40S-RHO-626	740-4503	417.60
Entry	ND53PD-RHO-626	740-4500	494.40
Entry	ND53LD RHO 626	740-4508	438.00
Entry	ND53LD-Athens-626	740-2512	438.00
Corridor	ND73PD RHO 626	740-4520	494.40
Classroom	ND70PD-RHO-626	740-4504	494.40
Classroom	ND70LD-RHO-626	740-4530	438.00
Classroom	ND73BD RHO 626	740-7073	494.40
Storeroom	ND80PD-RHO-626	740-4505	494.40
Storeroom	ND80BD SPA 626	740-4550	494.40
Storeroom	ND80LD-Athens-626	740-2515	438.00
Storeroom	ND80PD-RHO-605	740-4506	504.00
Storeroom	ND80LD RHO 626	740-4525	438.00

Double Cylinder Vestibule Lever, "E" keyway

Order #	Item #	Cat. Price
740-4535	ND60PD RHO E 626	\$586.80



Vandlgard™ Levers

D-Series Clutching Functions

Designed to disengage the outside spindle from the latch when in the locked condition.

Certification: ANSI A 156.2 1995, Series 4000 Grade 1 UL listed for 3 hour applications.

All locks less cylinder, and with 2-3/4" backset

Schlage D-Series keyed lever locks with Vandlgard provide vandal resistant technology. Designed for maximum accessibility, security and durability. The unique features of Vandlgard prevent damage to internal lock components caused by excessive force from persons kicking, hitting, or standing on the lever to gain access.

- All vandlgard functions have a 7-year Schlage warranty.
- Integrated spindle & spring cage greatly reduces lever sag & wobble.
- Free-wheeling lever eliminates the ability to stand or exert excessive force on the end of the lever.
- Installs in under 2 minutes. No more hassling with a castle nut.

13-048: Springlatch, 2-3/4" backset square corner, 1/2" throw

13-047: Deadlatch, 2-3/4" backset square corner, 1/2" throw

10-025: 1-1/4' x 4-7/8" ANSI Strike

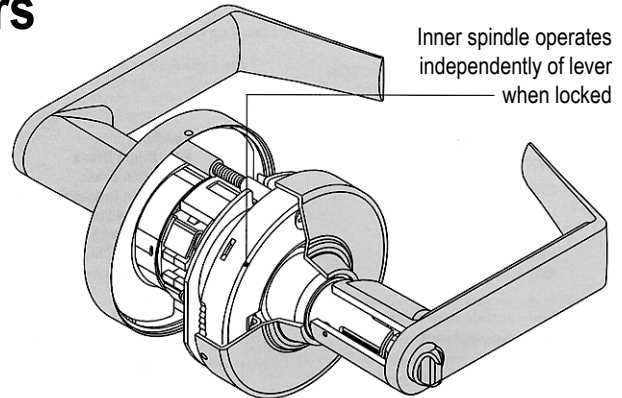

Vandlgard Functions (ANSI #)

Vandlgard is designed to disengage outside spindle from latch when in locked condition.

ND92LD (F109) Entrance Lock. Turn/push-button locking; pushing and turning button disengages outside lever, requiring use of key until button is manually unlocked. Push-button locking; pushing button disengages outside lever until unlocked by key or by turning inside lever.

ND93PD (F88) Classroom Security Lock Latch retracted by key from outside when outside lever is disengaged by key in inside lever. Inside lever is always unlocked. Classic "C".

ND94LD. (F84) Classroom Lock. Outside lever disengaged and unlocked by key. Inside lever always unlocked.

ND96LD. (F86) Storeroom Lock. Outside lever always disengaged. Entrance by key only. Inside lever always unlocked.

LD: Less Cylinder

Order #	Item #	Catalog Price
740-4600	ND92LD RHO 626	482.40
740-4630	ND93PD RHO 626	632.40
740-4610	ND94LD RHO 626	482.40
740-4620	ND96LD RHO 626	482.40

Schlage Vandlgard Classroom Security Lock

Classic "C", 0-Bitted

Order #	Item #	Catalog Price
740-4650	D95PD RHO 626	\$632.40

EVEREST™

About Schlage Everest

Everest, is a patented cylinder family from Schlage Lock Company. This patent prevents manufacturing and distribution of aftermarket key blanks by anyone other than Schlage. The new nickel silver key is 15% thicker to resist breakage, and the key bow is 25% larger for easier handling and customer marking.

Open keyways are sold to locksmiths for open duplication. End-users have the convenience of going to the locksmith of their choice for additional locks, cylinders and keys.

**SCHLAGE LOCK FUNCTIONS:
FOR A, D, F, & S SERIES**

- Passage: (10)** Both knobs always unlocked
- Privacy: (40)** Push button locking. Can be opened from the outside by small screwdriver. Turning inside knob or closing door releases button.
- Entrance/Office Lock (50)** (ANSI F82) Push-button locking. Push-button locks outside lever until unlocked with key or by rotating inside lever.
- Entry: (51)** "F" Series. Turn button inside, key lock outside. Inside always unlocked.
- Entry: (53)** "A" Series. Push & turn button to lock outside knob requires use of key until button is manually

unlocked. Push button to lock outside knob until unlocked by key or by turning inside knob.

- Store Lock: (66)** "D" Series. Key in either knob locks or unlocks both knobs.
- Classroom: (70)** Outside knob locked & unlocked by key. Inside knob always unlocked.
- Dormitory: (73)** Locked or unlocked by key from outside. Push button locking from inside. Turning inside knob or closing door releases button.
- Storeroom: (80)** Outside knob fixed. Entrance by key only. Inside always unlocked.
- Institution Lock: (82)** "D" Series. Both knobs fixed. Entrance by key in either knob.



"F" Series

Single and Multi-Family Residential Doors.

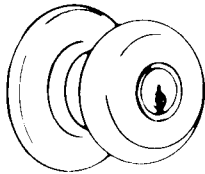

**Plymouth
PLY**

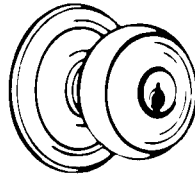

**Georgian
GEO**

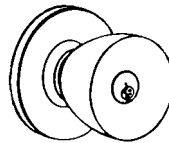

**Bell
BEL**

Supplied with Adjustable Latch.

Certifications: ANSI A156.2 Series 4000 Grade 2.

Keying: 5-pin tumbler, "C" Keyway

Door Range: 1-3/8" to 1-3/4".

Features: Pressure cast zinc tubular lock housing. Demountable outside knobs for easy cylinder replacement. Outside knob, rose and chassis, one single assembly; inside knob and rose, one single assembly; for easy lock installation.

Strikes: Square corner,
1-1/8" x 2-3/4" x 3/32"
"T" strike with 1-1/8" lip,
furnished with dust box.

NOTE: F10 & F40 use

- **Latch:** 16-080 Radius corner, Round faceplate
- **Strike:** 10-027 Radius corner

STOREROOM:

F80N-PLY-626	740-3025	65.16
F80N PLY-605	740-3027	60.84
F80N-GEO-609	740-3026	63.96
F80N-ORB-626	740-3024	75.96

PASSAGE:

ITEM	ORDER #	\$
F10N-BEL-605	(U) 740-3001	28.92
F10N-PLY-605	740-3003	28.92
F10N-PLY-626	740-3004	35.52
F10N-GEO-609	740-3005	32.88
F10N-ORB-605	740-3060	37.44
F10N-ORB-609	740-3045	41.16
F10N-ORB-626	740-3007	43.56

PRIVACY:

F40N-PLY-605	740-3010	33.12
F40N-PLY-626	740-3011	38.16
F40N-GEO-609	740-3012	37.44
F40N-ORB-605	740-3065	39.96
F40N-ORB-609	740-3050	43.92
F40N-ORB-626	740-3014	49.08

ENTRY:

F51N-BEL-605	(U) 740-3015	60.96
F51N-BEL-626	740-3016	58.56
F51N-PLY-605	740-3017	56.88
F51N-PLY-626	740-3018	60.96
F51N-GEO-605	740-3115	5⁰4
F51N-GEO-609	740-3019	59.76
F51N-ORB-605	740-3070	61.56
F51N-ORB-609	740-3030	67.68
F51N-ORB-626	740-3021	71.04



Callington

Champagne

Certification: ANSI A156.2, 1996, Series 4000, Grade 2
Latch: 1" x 2-1/4" Square Corner faceplate, 7/8" housing diameter, 1/2" throw with Triple-Option radius round corner and circular drive-in faceplates
Strikes: 1-5/8" x 2-1/4" square corner, full lip, no box
Backset: Dual Backset, for 2-3/8" to 2-3/4" backsets
Cylinder: 5-pin, C keyway, KD
Door Range: 1-3/8" to 1-3/4"
Keys: Two nickel silver cut keys per lock, 5-pin, C Section

Classic "C" Keyway

Callington Levers

Order #	Item #	Catalog Price
740-9110	FA10 505	\$67.92
740-9111	FA40 605	65.04
740-9112	FA51 505	138.00

Champagne Levers

Order #	Item #	Catalog Price
740-9115	FA10 620	\$69.84
740-9116	FA40 620	75.12
740-9117	FA51 620	144.00
740-9120	FA10 625	\$69.84
740-9121	FA40 625	75.12
740-9122	FA51 625	144.00

FA10. Passage - Hall/Closet Lock

- Both levers always unlocked



FA40. Privacy - Bed/Bath Lock

- Push button locking
- Can be opened from outside with small circular tool
- Turning inside lever unlocks outside



F51. Keyed Entrance lock

- Turn button locking
- Unlocked by key outside or by turn button inside
- Inside lever always locked

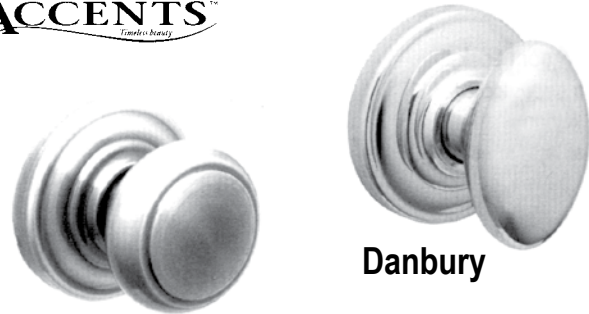

Andover

Danbury

Certification: ANSI A156.2, 1996, Series 4000, Grade 2
Latch: 1" x 2-1/4" Square Corner faceplate, 7/8" housing diameter, 1/2" throw with Triple-Option radius round corner and circular drive-in faceplates
Strikes: 1-5/8" x 2-1/4" square corner, full lip, no box
Backset: Dual Backset, for 2-3/8" to 2-3/4" backsets
Cylinder: 5-pin, C keyway, KD
Door Range: 1-3/8" to 1-3/4"
Keys: Two nickel silver cut keys per lock, 5-pin, C Section

Classic "C" Keyway

Andover Knobs

Order #	Item #	Catalog Price
740-9125	FA10 505	\$42.36
740-9126	FA40 605	39.96
740-9127	FA51 505	69.00

740-9130	FA10 620	\$43.56
740-9131	FA40 620	49.08
740-9132	FA51 620	71.04

Danbury Knobs

Order #	Item #	Catalog Price
740-9135	FA10 505	\$58.56
740-9136	FA40 605	56.40
740-9137	FA51 505	107.52

740-9140	FA10 625	\$60.24
740-9141	FA40 625	63.84
740-9142	FA51 625	110.88

NOTE: F10 & F40 use

- Latch: 16-080 Radius corner, Round faceplate
- Strike: 10-027 Radius corner



F-Series Lever Designs

16-210 Spring latch (Triple option 2-3/8 or 2-3/4" backset springlatch)

16-211 Dead latch (Triple option 2-3/8 or 2-3/4" backset deadlatch)

NOTE: F10 & F40 use

- **Latch:** 16-080 Radius corner, Round faceplate
- **Strike:** 10-027 Radius corner

FLAIR:

Order #	Item #	Price
740-3201	F10 FLA RH 605	51.00
740-3211	F10 FLA RH 609	56.16
740-3221	F40 FLA RH 605	54.96
740-3230	(U) F40 FLA LH 609	60.36
740-3231	F40 FLA RH 609	60.36
740-3241	F51 FLA RH 605	104.64
740-3251	F51 FLA RH 609	115.08
740-3260	F170 FLA LH 605	22.32
740-3261	F170 FLA RH 605	22.32
740-3270	F170 FLA LH 609	24.60
740-3271	F170 FLA RH 609	24.60

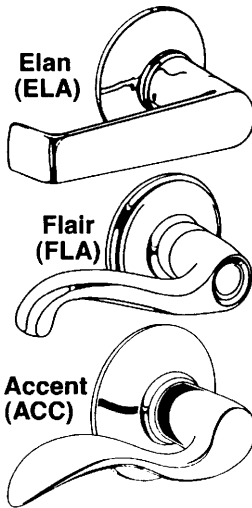

Schlage "C" keyway

- F10: Passage
- F40: Privacy
- F51: Entry
- F170: Dummy



ACCENT:

Order #	Item #	Cat. Price
740-3281	F10 ACC RH 605	\$52.08
740-3282	F10 ACC RH-619	60.12
740-3291	F40 ACC RH 605	56.04
740-3292	F40 ACC RH-619	64.68
740-3302	F51 ACC RH-619	122.60
740-3284	F10 ACC RH-620	60.12
740-3294	F40 ACC RH-620	64.68
740-3300	(U) F51 ACC LH 605	106.56
740-3301	F51 ACC RH 605	106.56
740-3304	F51 ACC RH-620	123.60
740-3310	F170 ACC LH 605	22.80
740-3311	F170 ACC RH 605	22.80

ELAN:

740-3035	F10N-ELA-626	\$59.04
740-3040	F40N-ELA-626	63.36
740-3279	F170 ELA 626	25.80

Single Dummy

740-3013	F170 PLY 626	\$14.56
----------	--------------	----------------



HANDLESETS

**"F" Series
Solid Forged
Brass**

**Residential
Grip Handle
Entrance
Locks**

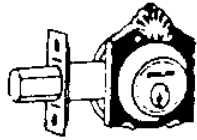

**PARTHENON
PAR**

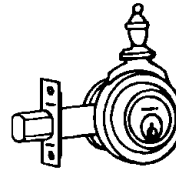

**BOWMAN
BOW**

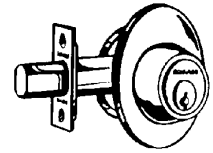

**PLYMOUTH
PLY**

Keying: 5 pin tumbler "C" keyway.

Door Range: 1-5/8" to 1-3/4".

Backset: Furnished with adjustable dead-bolt and latch for either 2-3/8" or 2-3/4" backsets.

Function: Deadbolt thrown or retracted by key from outside or by inside turn unit. Latch retracted by thumb piece from outside or by inside knob. Georgian knob on the inside.

Standard Duty B160 Series Deadbolt.

Order #	Item #	Price
740-3120	F360NV-BOW/ORB-605	\$258.00
740-3122	F360NV-BOW/ORB-609	276.84
740-3109	F360NV-PAR/GEO-609	267.84
740-3110	F360NV-PLY/PLY-605	239.28

More Finishes:

619: Satin Nickel • 620: Antique Pewter

Order #	Item #	Catalog Price
740-3315	F360 PLY-619 x ACC LH-619	\$312.00
740-3316	F360 PLY-619 x ACC RH-619	312.00
740-3317	F360 PLY-620 x ACC LH-620	312.00
740-3318	F360 PLY-620 x ACC RH-620	312.00



L9000-Series

Exploded View - L9050P

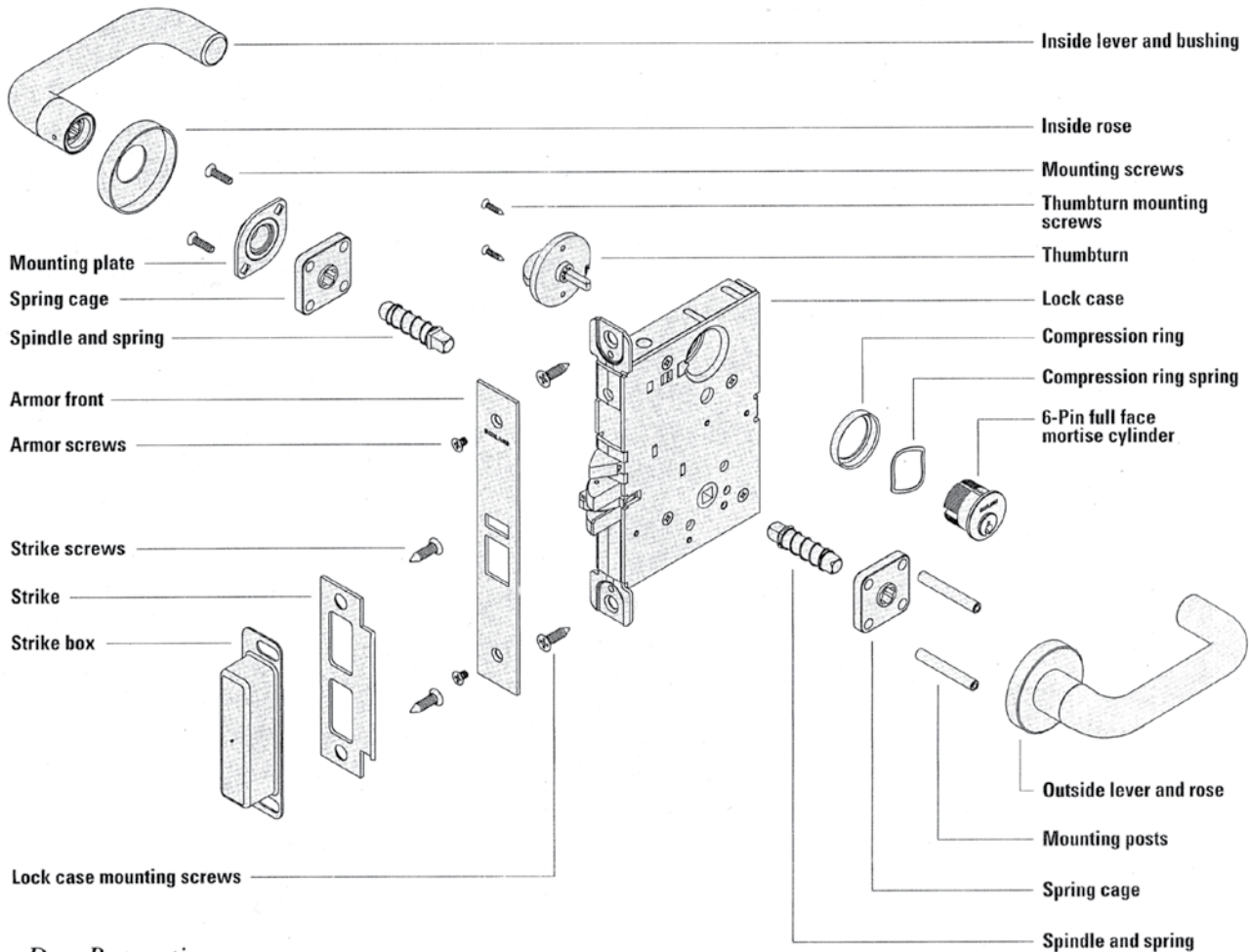

Door Preparation

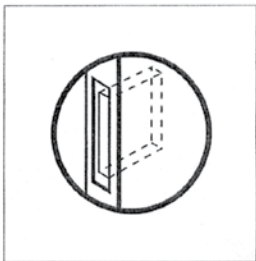

L • Functions

ANSI A156.13, 1994, Series 1000

Mortise Locks—Non-Keyed

SCHLAGE ANSI

L9010 F01



Passage Latch

Latchbolt retracted by knob/lever from either side at all times.

L9040 F22



Bath/Bedroom Privacy Lock

Latchbolt retracted by knob/lever from either side unless outside is locked by inside turn piece. Turning inside knob/lever or closing door unlocks outside knob/lever. To unlock from outside, remove emergency button, insert emergency turn (furnished) in access hole and rotate.

L9044

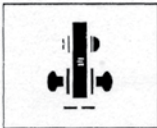

Privacy With Coin Turn Outside

Latchbolt retracted by knob/lever from either side unless outside is locked by inside thumbturn or outside coin turn. Operating inside knob/lever, closing door, rotating inside thumbturn or rotating outside coin turn unlocks outside knob/lever. Specify per L283-056 for Torx® screws. Available with rose trim only. (Previously XL11-868)

L9440

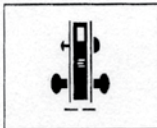

Privacy With Deadbolt

Latchbolt retracted by knob/lever from either side. Deadbolt thrown or retracted by inside thumbturn. Throwing deadbolt locks outside knob/lever. Rotating inside knob/lever simultaneously retracts deadbolt and latchbolt, and unlocks outside knob/lever. To unlock from outside, remove emergency button, insert furnished turn piece in access hole and rotate. (Previously XL11-761)

L9444



Privacy With Deadbolt and Coin Turn Outside

Latchbolt retracted by knob/lever from either side. Deadbolt thrown or retracted by inside thumbturn or outside coin turn. Throwing deadbolt locks outside knob/lever. Rotating inside knob/lever simultaneously retracts deadbolt and latchbolt, and unlocks outside knob/lever. Rotating outside coin turn retracts deadbolt and unlocks outside knob/lever. Specify per L283-056 for Torx screws. Available with rose trim only. (Previously XL11-868)

Mortise Locks—Non-Keyed Dummy

SCHLAGE ANSI

L0170

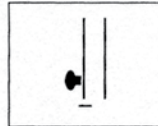

Single Dummy Trim

Knob/lever on one side fixed by mounting bar.

L0172

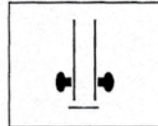

Double Dummy Trim

Knob/lever on both sides fixed by mounting bar.

L9175

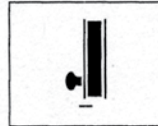

Single Dummy w/ Lock Case

Knob/lever on one side inoperable. Includes lock case and armor front.

L9176



Double Dummy w/ Lock Case

Knob/lever on both sides inoperable. Includes lock case and armor front.



Functions - L

Functions • L

Mortise Locks—Keyed

SCHLAGE ANSI

L9050 F04

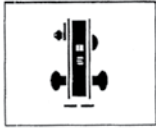

Office and Inner Entry Lock

Latchbolt retracted by knob/lever from either side unless outside is made inoperative by key outside or by turning inside thumbturn. When outside is locked, latchbolt is retracted by key outside or by knob/lever inside. Outside knob/lever remains locked until thumbturn is returned to vertical or unlocked by key. Auxiliary latch deadlocks latchbolt when door is closed.

L9056



L9050 With Simultaneous Retraction

Latchbolt retracted by knob/lever from either side unless outside is made inoperative by key outside or by rotating inside thumbturn. Outside knob/lever unlocked by key outside, thumbturn, or closing door. Rotating inside knob/lever simultaneously retracts latchbolt and unlocks outside knob/lever. Auxiliary latch deadlocks latchbolt when door is closed. (Previously XL11-776)

L9060 F09



Apartment Entrance Lock

Latchbolt retracted by knob/lever from either side unless outside is locked by key from inside. When locked, latchbolt retracted by key outside or knob/lever inside. Auxiliary latch deadlocks latchbolt when door is closed.

L9070 F05

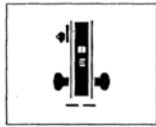

Classroom Lock

Latchbolt retracted by knob/lever from either side unless outside is locked by key. Unlocked from outside by key. Inside knob/lever always free for immediate exit. Auxiliary latch deadlocks latchbolt when door is closed.

Mortise Locks—Keyed

SCHLAGE ANSI

L9071



Classroom Security Lock

Latchbolt retracted by knob/lever from either side unless outside is locked by key from either side. When locked, latchbolt retracted by key outside or knob/lever inside. Auxiliary latch deadlocks latchbolt when door is locked.

L9076 F06

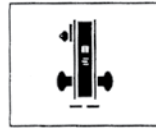

Classroom Holdback Lock

Latchbolt retracted by knob/lever from either side unless outside is locked by key. When locked, latchbolt retracted by key outside or knob/lever inside. Auxiliary latch deadlocks latchbolt when door is closed. Depress inside knob/lever and turn key 360° for holdback feature.

L9077



Classroom Security Holdback Lock

Latchbolt retracted by knob/lever from either side unless outside is locked by key from either side. When locked, latchbolt retracted by key outside or knob/lever inside. Auxiliary latch deadlocks latchbolt when door is locked. Depress inside knob/lever and turn key 360° for holdback feature.

L9080 F07



Storeroom Lock

Latchbolt retracted by key outside or by knob/lever inside. Outside knob/lever always inoperative. Auxiliary latch deadlocks latchbolt when door is closed.

L9080EL

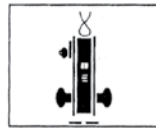

Electrically Locked (Fail Safe)

Outside knob/lever continuously locked by 24V AC or DC. Latchbolt retracted by key outside or by knob/lever inside. Switch or power failure allows outside knob/lever to retract latchbolt. Auxiliary latch deadlocks latchbolt when door is closed. Inside knob/lever always free for immediate exit.

L9080EU



Electrically Unlocked (Fail Secure)

Outside knob/lever unlocked by 24V AC or DC. Latchbolt retracted by key outside or knob/lever inside. Auxiliary latch deadlocks latchbolt when door is closed. Inside knob/lever always free for immediate exit.



L • Functions

Functions - L

Mortise Locks—Keyed

SCHLAGE ANSI

L9080EL-RX
L9080EU-RX

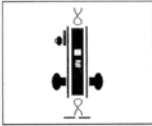

Request To Exit (RX) Electrified Lock

Same as L9080EL and L9080EU functions. In addition, a micro switch positioned inside the lock case monitors the retractor crank, and is actuated when rotation of the inside or outside knob/lever rotates the retractor hub. The switch signals the use of that opening to security systems, allowing a non-disruptive means of immediate egress. Specify per L283-059 for normally closed contacts (default). Specify L283-125 for normally open contacts. (Previously XL11-807)

L9082

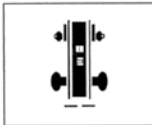

Institution Lock*

Latchbolt retracted by key from either side. Knob/lever on both sides always inoperative. Auxiliary latch deadlocks latchbolt when door is closed.

L9082EL
L9082EU



L9082 Electrically Locked or Electrically Unlocked Both Sides*

EL: Outside and inside knob or lever continually locked electrically. Latchbolt retracted by key either side. Switch or power failure allows outside and inside knob/lever to retract latchbolt. Auxiliary latch deadlocks latchbolt when door is closed. EU: Outside and inside knob/lever unlocked electrically. Latchbolt retracted by key either side. Switch or power failure keeps inside and outside knob/lever locked. Auxiliary latch deadlocks latchbolt when door is closed. (Previously XL11-452)

L9453 F20



Entrance Lock

Latchbolt retracted by knob/lever from either side unless outside is locked by 20° rotation of thumbturn. Deadbolt thrown or retracted by 90° rotation of thumbturn. When locked, key outside or knob/lever inside retracts deadbolt and latchbolt simultaneously. Outside knob/lever remains locked until thumbturn is restored to vertical position. Throwing deadbolt automatically locks outside knob/lever. Auxiliary latch deadlocks latchbolt when door is closed.

Mortise Locks—Keyed

SCHLAGE ANSI

L9456 F13



Corridor Lock

Latchbolt retracted by knob/lever from either side. Deadbolt thrown or retracted by key outside or inside thumbturn. Throwing deadbolt locks outside knob/lever. Turning inside knob/lever simultaneously retracts deadbolt and latchbolt and unlocks outside knob/lever.

L9457



Classroom Security Lock

Latchbolt retracted by knob/lever from either side. Deadbolt thrown or retracted by key from either side. Throwing deadbolt locks outside knob/lever. Turning inside knob/lever simultaneously retracts deadbolt and latchbolt and unlocks outside knob/lever.

L9465



Closet/Storeroom Lock

Latchbolt retracted by knob/lever from either side. Deadbolt thrown or retracted by key outside.

L9466 F14



Store/Utility Room Lock*

Latchbolt retracted by knob/lever from either side. Deadbolt thrown or retracted by key from either side.

L9473 F21



Dormitory/Bedroom Lock

Latchbolt retracted by knob/lever from either side. Deadbolt thrown or retracted by key outside or thumbturn inside.



* *Caution: Double cylinder locks on residences and any door in any structure which is used for egress are a life safety hazard in times of emergency and their use is not recommended. Installation should be in accordance with existing codes only.*

Functions - L

Functions • L

Mortise Locks—Keyed

SCHLAGE ANSI

L9480



Storeroom Lock With Deadbolt

Latchbolt retracted by key outside or by lever or knob inside. Outside knob/lever always fixed. Deadbolt thrown or retracted by key outside or thumbturn inside. Turning inside knob/lever simultaneously retracts both deadbolt and latchbolt. Auxiliary latch deadlocks latchbolt when door is closed. (Previously XL11-591)

L9485



Hotel Lock

Latchbolt retracted by key outside or by knob/lever inside. Outside knob/lever always fixed. Deadbolt thrown or retracted by inside thumbturn. When deadbolt is thrown, all keys become inoperative except emergency or display keys. Turning inside knob/lever retracts both deadbolt and latchbolt simultaneously. Auxiliary latch deadlocks latchbolt when door is closed.

L9486 F15



Hotel Lock w/ "Do Not Disturb" Indicator

Latchbolt retracted by key outside or by knob/lever inside. Outside knob/lever always fixed. Deadbolt thrown or retracted by inside thumbturn. When deadbolt is thrown, "DO NOT DISTURB" plate is displayed. All keys become inoperative except emergency or display keys. Turning inside knob/lever retracts both deadbolt and latchbolt simultaneously. Auxiliary latch deadlocks latchbolt when door is closed.

Mortise Locks—Keyed

SCHLAGE ANSI

L9486



L9486 With "OCCUPIED" Indicator

Latchbolt retracted by key outside or by knob/lever inside. Outside knob/lever always fixed. Deadbolt thrown or retracted by inside thumbturn. When deadbolt is thrown, "OCCUPIED" plate is displayed and all keys become inoperative except emergency keys. Turning inside knob/lever simultaneously retracts both deadbolt and latchbolt. Auxiliary latch deadlocks latchbolt when door is closed. Specify per L583-375. (Previously XL11-580)

L9496



Privacy With "OCCUPIED" Indicator

Knob/lever retracts latchbolt from either side. Deadbolt thrown or retracted by key outside (retraction by key required in the event of an emergency) or inside thumbturn. Throwing deadbolt locks outside knob/lever and displays "OCCUPIED" plate. Rotating inside knob/lever simultaneously retracts both deadbolt and latchbolt and unlocks outside knob/lever. (Previously XL11-885)



L • Functions

Functions - L

Mortise Locks—Keyed Deadbolts

SCHLAGE ANSI

L9460 F17



Cylinder x Thumbturn Lock
Deadbolt thrown or retracted by key outside or thumbturn inside.

L9462 F16

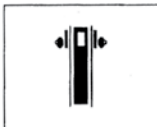

Double Cylinder Lock*
Deadbolt operated by key from either side.

L9463

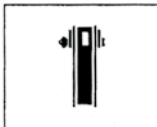

Classroom Lock
Deadbolt thrown or retracted by key from outside. Inside cylinder turn retracts deadbolt but cannot project it.

L9464 F18

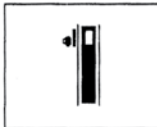

Cylinder Lock
Deadbolt thrown or retracted by key from one side. No trim on opposite side.

ANSI A156.5, 2001

Mortise Locks—Small Case Deadbolts

SCHLAGE ANSI

L460 E06071



Cylinder x Thumbturn Lock
Deadbolt thrown or retracted by key outside or thumbturn inside.

L462 E06061

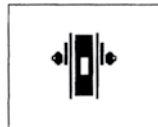

Double Cylinder Lock*
Deadbolt operated by key from either side.

L463 E06091

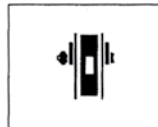

Classroom Lock
Deadbolt thrown or retracted by key from outside. Inside cylinder turn retracts deadbolt but cannot project it.

L464 E06081

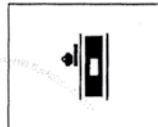

Cylinder Lock
Deadbolt thrown or retracted by key from one side. No trim on opposite side.

L480

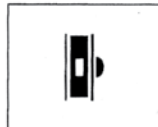

Door Bolt
Deadbolt thrown or retracted by thumbturn from one side. No trim on opposite side.

L496



Deadbolt With "OCCUPIED" Indicator
Deadbolt thrown or retracted by key outside or thumbturn inside. When deadbolt is thrown "OCCUPIED" plate is displayed. (Previously XL11-911)

* **Caution:** Double cylinder locks on residences and any door in any structure which is used for egress are a life safety hazard in times of emergency and their use is not recommended. Installation should be in accordance with existing codes only.

Functions - L

Functions • L

Special Functions

SCHLAGE

L9110

**Double Dummy With Active Trim**

Knob/lever both sides always active. Includes lock case and armor front. Specify per XL11-741. May be ordered with optional XL11-743 armor front with cutout to receive deadbolt only.

L9040

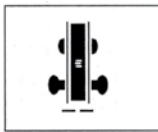
**Privacy With Turns Both Sides**

Latchbolt retracted by knob/lever from either side unless outside is locked by inside or outside thumbturn. Operating inside knob/lever, closing door or rotating either thumbturn unlocks outside knob/lever. Specify per XL11-446.

L9412

**Exit Lock With Deadbolt**

Latchbolt retracted by knob/lever inside. Outside knob/lever always fixed. Deadbolt thrown or retracted by inside thumbturn. Turning inside knob/lever retracts both deadbolt and latchbolt simultaneously. Auxiliary latch deadlocks latchbolt when door is closed. Specify per XL11-907.

L9460

**L9460 With Fixed Dummy Trim**

Knob/lever both sides fixed. Deadbolt thrown or retracted by key outside or thumbturn inside. Specify per XL11-635.

L9460, L9462, L9464

**Deadbolt With Retraction By Inside Lever or Knob**

L9460: Deadbolt thrown or retracted by key outside or thumbturn inside. Outside knob/lever always fixed.

Inside knob/lever active when deadbolt is extended. Rotating inside knob/lever will retract deadbolt.

L9462: Same as above, except deadbolt thrown or retracted by key from either side.

L9464 (shown): Same as above, except deadbolt thrown or retracted by key from one side. Specify desired function per XL11-886.

Special Functions

SCHLAGE

L9482

**Institution Lock With Deadbolt***

Latchbolt retracted by key from either side. Knob/lever on both sides always inoperative. Deadbolt thrown or retracted by key either side. Auxiliary latch deadlocks latchbolt when door is closed. Specify per XL11-543.

L9485

**Prison Function Lock**

Latch retracted by key outside or knob inside. Outside knob always free spinning. Deadbolt only thrown or retracted by guard's key. Inside knob becomes fixed when deadbolt is thrown. Prisoner's key only retracts latchbolt. Furnished standard with tamper resistant Torx® screws. Specify per XL11-557.



* **Caution:** Double cylinder locks on residences and any door in any structure which is used for egress are a life safety hazard in times of emergency and their use is not recommended. Installation should be in accordance with existing codes only.



L Series: Extra Heavy Duty Mortise Locks

For commercial and institutional buildings where the finest in mortise locks are required.

Certifications: ANSI A156.13, 1897 Grade 1 Operational, Grade 3 Security. ANSI/ASTM F476-76 Grade 20. U.L. Listed.

Case size: 4-7/16" x 6-1/16" x 1"

Armored Front: 1-1/4" x 8" x 7/32" standard

Latchbolt: 3/4" throw stainless steel with anti-friction tongue.

Backset: 2-3/4" only.

Exceeds ANSI A156.2 Grade 1 lock lever torque requirements.

Exceeds 800,000 cycle ANSI Grade 1 requirements

Non-handed lock case.

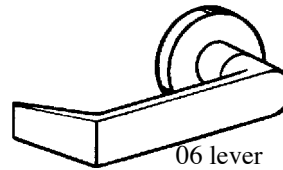

06 lever

LESS CYLINDER

Cylinder not included, order from "Repair Parts" section.

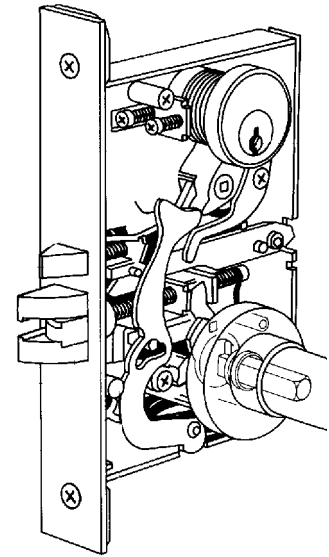

Schlage Mortise Lever Sets, Less Cylinder

09-663 square corner armor front - 1-1/4" width, 10-072 standard square corner strike

Order #	Item #	Function	Price
740-9010	L9050L 06A 626 RH	Entry	\$652.80
740-9020	L9070L 06A 626 RH	Classroom	652.80
740-9030	L9080L 06A 626 RH	Storeroom	652.80

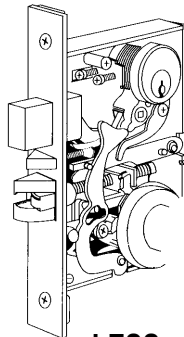
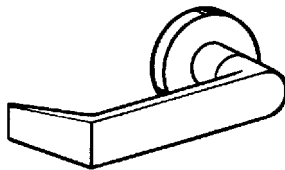

LESS CYLINDER

Mortise Leverset.

Entry function, less cylinder. 10-072 strike.

Order #	Item #	Catalog Price
740-9040	L9453L 06A 626	\$584.40

Lock is furnished with 03a lever.

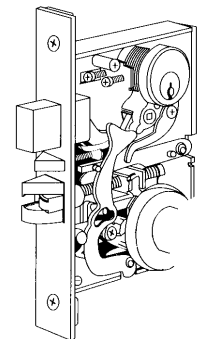
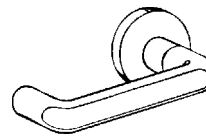

LESS CYLINDER

"L" Series Heavy Duty Mortise Lock with 03a Lever

Order #	Item #	Price
740-9001	L9456L-03A-630	\$702.00

Refer to Function Charts on Previous Pages



B60 SERIES

REPLACES THE B360 SERIES

Provides more security, more style, and is designed to install in a snap.

Faster, Easier Installation

- 3-piece assembly
- Installs in half the time
- SNAP & STAY™ feature for hands-free installation

Enhanced Security

- BHMA Grade 1 product performance
- Increased latch/bolt size offers max. kick-in resistance. 1" Door prep required
- Exclusive patented Schlage design
- Anti-pick shield

Sleek, Low Profile Design

- Larger thumbturn is easier to grip (ADA compliant)
- Contoured edges for added style
- Adjustable backset fits both 2-3/8" and 2-3/4"



Order #	Item #	Cylinders	Catalog Price
740-3600	B60N-619	Single	\$64.80
740-3615	B62N-619	Double	89.88
740-3610	B60N-620	Single	64.80
740-3620	B62N-620	Double	89.88

Charlotte Warehouse only: NEW Finishes

Order #	Item #	Cylinder	Catalog Price
740-3630	B60N 626	Single	\$64.80
740-3640	B60N 605	Single	56.04



BA-Series Residential Deadbolts

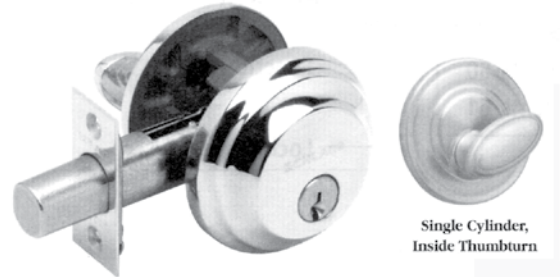

Single Cylinder, Inside Thumbturn

Certification: ANSI A156.5, 2001, Grade 2 auxiliary lock

Deadbolt: 1" x 2-1/4" Square Corner, 7/8" housing diameter, 1" throw with Triple-Option radius round corner and circular drive-in faceplates

Strikes: 1-1/8" x 2-3/4" square corner, box

Reinforcement: Door frame strike reinforcer with 3" screws

Backset: Universal for 2-3/8" to 2-3/4" backsets

Cylinder: 5-pin solid brass, keyed 5-pin, C keyway, KD

Door Range: 1-3/8" to 2"

Keys: Two nickel silver cut keys per lock, 5-pin, C Section

Trim Ring: 7/8" Wrought brass, reinforced with security insert

BA360. Single Cylinder Deadbolt

- Deadbolt thrown or retracted by key from outside or by inside turn unit
- Bolt deadlocks when fully thrown

BA362. Double Cylinder Deadbolt

- Deadbolt thrown or retracted by key from either side
- Bolt deadlocks when fully thrown

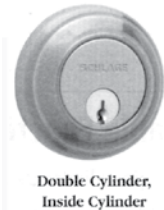

Double Cylinder, Inside Cylinder

Deadbolts. Classic "C" Keyway

Order #	Item #	Type	Catalog Price
740-9100	BA360 505/605	Single Cyl.	\$72.48
740-9101	BA360 620	Single Cyl.	74.64
740-9102	BA360 625	Single Cyl.	74.64
740-9105	BA362 505/605	Double Cyl.	95.64
740-9106	BA362 620	Double Cyl.	98.52
740-9107	BA362 625	Double Cyl.	98.52

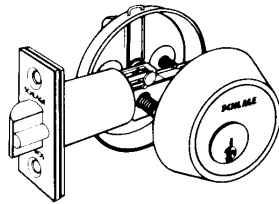

B200 Series Deadlatch

Night Latches

Deadlocking latchbolt prevents "shimming" of latch with credit cards, screwdriver or similar tool. Contains a holdback feature which retains deadlatch in a retracted position when desired. 1-3/8 or 1-3/4" Door 9/16" throw deadlocking latch. 5-Pin brass cylinder "C" keyway. 2-3/8" Backset.

B200 Series Deadlatch Night Latches

Single Cylinder: B250;

Item	Order #	Catalog Price
SCH-B250PD-605	740-4078	\$234.00
SCH-B250PD-626	740-4080	216.00

Double Cylinder: B252

SCH-B252PD-605	740-4086	255.60
SCH-B252PD-626	740-4088	237.60



B500 Series Deadbolt Commercial Deadbolts

The best deadbolt ever designed by you

Introducing the B500 Series deadbolt from Schlage, a revolutionary new deadbolt that delivers higher security, tougher performance, and the ultimate in installation versatility. Designed by locksmiths for locksmiths, the B500 Series deadbolt can be fitted with any Schlage cylinder, fits virtually every door you service, enhances lock strength on the jamb side of the door, and will change forever the way you look at deadbolts.

Finishes	
605	Bright Brass
609	Antique Brass
612	Satin Bronze
613	Oil Rubbed Bronze
619	Satin Nickel
625	Bright Chrome
626	Satin Chrome
716	Aged Bronze



No Other Deadbolt Comes Close:

- Adjustable backset with lock-in-place helix design
- Integrated anti-pry shield behind latch
- Thicker metal security strike back-up on jamb side
- Security strike on jamb has third screw for deeper anchoring
- Added space in side strike box for true deadlatch
- Seamless steel construction from beginning of helix to back of bolt
- 10% larger diameter deadbolt
- Zinc bolt with spinning hardened steel pin inside
- Tapered front housing that can't be unscrewed
- Integrated trim piece for fewer pieces out of the box
- ADA compliant thumbturn
- Accepts any Schlage cylinder

..... Classic "C" Keyway

Replaces the B160 Series.

Order #	Item #	Cylinder	Catalog Price
740-4101	B560P-605	Single	\$67.20
740-4118	B560P-609	Single	73.20
740-4112	B560P-612	Single	73.20
740-4128	B560P-613	Single	73.20
740-4119	B560P-619	Single	73.20
740-4125	B560P-625	Single	70.80
740-4110	B560P-626	Single	70.80
740-4100	B560P-716	Single	73.20
740-4136	B562P-605	Double	91.20
740-4153	B562P-609	Double	97.20
740-4142	B562P-612	Double	97.20
740-4148	B562P-613	Double	97.20
740-4139	B562P-619	Double	97.20
740-4155	B562P-625	Double	94.80
740-4145	B562P-626	Double	94.80
740-4130	B562P-716	Double	97.20



Commercial Deadbolts

B500 Series Deadbolts

Everest C123 Keyway



Single Cylinder:

Order #	Item #	Latch	Price
740-6201	B560P 605	12-287	67.20
740-6203	B560P 626	12-287	70.80

Double Cylinder

740-6210	B562P 605	12-287	\$91.20
740-6213	B562P 626	12-287	94.80

Classic "E" Keyway

SINGLE CYLINDER 6-pin "E"

ITEM	ORDER #	Cat. Price
SCH-B560PE-605	740-4005	\$67.20
SCH-B560PE-626	740-4014	70.80
SCH-B560PE-609	740-4022	73.20
SCH-B560PE-613	740-4032	73.20

DOUBLE CYLINDER 6-pin "E"

SCH-B562PE-605	740-4040	\$91.20
SCH-B562PE-626	740-4049	94.80
SCH-B562PE-613	740-4067	97.20

Schlage Indicator Deadbolts.



B500-Series

Occupancy indicator that reads "In Use" in Red, or "Vacant" in Green, on the exterior trim plate.

Order #	Item #	Catalog Price
740-4160	B571-626	\$57.60



Commercial Deadbolts

••• For Interchangeable Core •••

(core not included)

Single Cylinder for IC Core, less core

Order #	Item #	Core Format	Price
740-6300	B560BD 626	Small	\$92.40
740-6310	B560J 626	Large	96.00

Double Cylinder for IC Core, less core

740-6305	B562BD 626	Small	\$100.80
740-6315	B562J 626	Large	104.40

Schlage Turnbolts,



Thumb Turn Only, No Cylinder, No Outside Trim. 12-270 triple option adjustable latch

Order #	Item #	Catalog Price
740-4030	B580 626	\$55.20
740-4020	B580 609	57.60

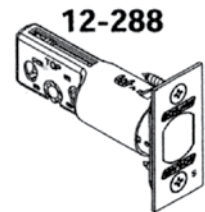
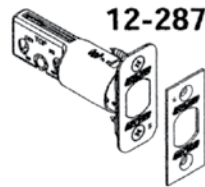

Latches for B500 Series Deadbolts

Adjustable Backset, 2-3/8" or 2-3/4"

12-287: Triple option, 1/4" radius round corner faceplate with 1" x 2-1/4" square corner and circular faceplates

12-288: Square corner, 1" x 2-1/4"

Order #	Item #	Catalog Price
740-0070	12-287 605	\$43.04
740-0071	12-287 626	43.04
740-0072	12-288 605	34.46
740-0073	12-288 626	34.56

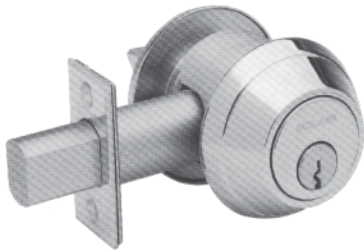

B600 Series Heavy Duty Commercial Grade Deadbolt

- Built to withstand the demands of the toughest commercial uses, it is also suitable for residential use.
- Exceeds ANSI 156.2 Grade 1 requirements with security and strength features. It has solid brass trim rings, 1/4" throughbolts and a high-strength, solid steel alloy bolt.
- Keying: Six-pin tumbler with two nickel silver keys per lock. Stock locks are keyed 5 pin.
- Door Range: 1.75" to 2" (44mm to 51mm) standard.
- Door Preparation: Fits 2-1/8" (54mm) crossbore with metal shield or a 1-1/2" (38mm) cross bore without the metal shield.
- Concealed screws on double cylinder versions.
- Wood frame reinforcer with 3" screws.

Single Cylinder Deadbolts

Order #	Item #	Keyway	Backset	Cat. Price
740-5500	B660P 626	Classic C	2-3/8"	\$174.00
740-5501	B660P x 626	C123	2-3/4"	174.00
740-5505	B660P 605	Classic C	2-3/8"	181.20
740-5509	B660PC 609	Classic C	2-3/8"	181.20
740-5510	B660P 613	Classic C	2-3/8"	181.20
740-5515	B660P 626	Classic C	2-3/4"	174.00
740-5520	B660PE 626	Classic E	2-3/8"	174.00

B/BA Series Latch

Triple Option Deadbolt Latch

Order #	Item #	Catalog Price
740-0001	12-300-626	\$29.38
740-0002	12-300-605	29.38

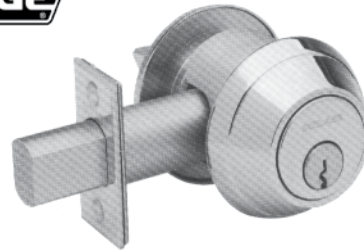
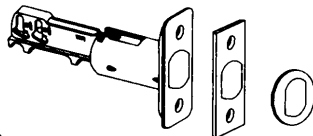

Double Cylinder Deadbolts

Order #	Item #	Backset	Each
740-5525	B662P 626	2-3/8"	223.20
740-5530	B662P 605	2-3/8"	230.40
740-5529	B662PC 609	2-3/8"	230.40
740-5535	B662P 613	2-3/8"	230.40
740-5540	B662P 626	2-3/4"	223.20
740-5545	B662PE 626*	2-3/8"	223.20

* "E" Keyway. All others are "C" Keyway.

Classroom Deadbolt Lock

Grade 1 Deadbolt thrown or retracted by key outside. Inside turn unit will retract bolt only. Bolt automatically deadlocks when fully thrown. 2-3/8" Backset.

Order #	Item #	Backset	Price
740-5575	B663PC 626	2-3/8"	181.20
740-5576	B663PC 626	2-3/4"	181.20
740-5571	B663PE 626*	2-3/4"	181.20

Replacement Bolts for B600 Series.

Bolts have adjustable face plates for right or left handed flat or beveled edge doors. All feature a concealed hardened steel roller for added resistance to sawing or cutting. 1 1/8" Square corner, standard. **\$41.74 each**

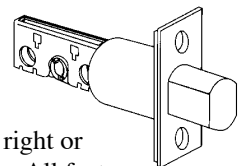

Order #	Item #	Backset
740-5550	12-631 605	2-3/4"
740-5555	12-631 626	2-3/4"
740-5560	12-630 626	2-3/8"
740-5565	12-630 605	2-3/8"

A Series
Springlatch
Standard
11-005

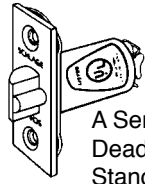
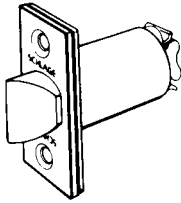

A Series
Deadlatch
Standard
11-085

A Series Plain Latch:

Order #	Schlage #	Backset	Price
740-0017	11-005-605	2-3/8	\$47.32
740-0018	11-005-626	2-3/8	47.32
740-0025	11-020-605	2-3/4	47.32
740-0026	11-020-626	2-3/4	47.32

A Series Dead Latch:

740-0019	11-085-605	2-3/8	47.32
740-0020	11-085-626	2-3/8	47.32
740-0021	11-096-605	2-3/4	47.32
740-0022	11-096-626	2-3/4	47.32
740-0028	11-102-626	3-3/4	50.84
740-0130	41-005	5" link	19.32
740-0029	11-104	2-3/8 DIB	47.32
740-0031	11-105	2-3/4 DIB	47.32

"F" Series Adjustable Latches

Adjustable Plain Latch
\$17.30

740-0181	16-200-605
740-0182	16-200-626
740-0183 (U)	16-202-626 DIB

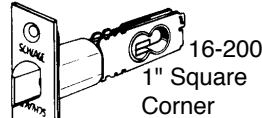

16-200
1" Square
Corner

Adjustable Dead Latch

Triple Option • Universal latch,
For F-Series keyed entry knobs
\$19.50

740-0184	16-211-605
740-0185	16-211-626

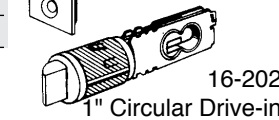

16-202
1" Circular Drive-in

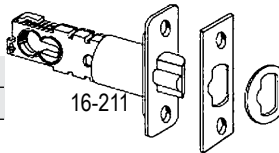

16-211

Bolts & Latches

For B600/700/800 Series Deadbolts

1" Throw, 1" Housing

\$41.74 ea.

Order #	Item #	Type	Backset
740-0062	12-630 626	Square Bolt	2-3/8"
740-0064	12-631 626	Square Bolt	2-3/4"
740-0063	12-640 626	Drive-In	2-3/8"
740-0065	12-641 626	Drive-In	2-3/4"

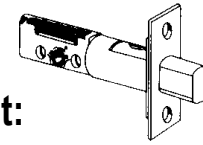

B & BC Series Deadbolt:

Order #	Item #		Price
740-0050	(U)12-270-626	Triple Adjustable	\$20.02
740-0055	12-270-605	Triple Adjustable	20.02
740-0047	(U)12-274-605	Adjustable	16.26
740-0048	12-274-626	Adjustable	16.26
740-0049	12-268	Adj. DIB	16.26

Adjustable bolts function as either 2-3/8 or 2-3/4" backset
Triple Adjustable bolts: 2-3/8", 2-3/4", Drive-In.

B400, B500 Series Deadbolt:

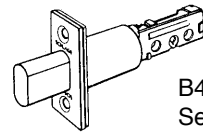

B400, B500 Series

Order #	Item #	Backset	Price
740-0034	12-073-626	2-3/8	\$46.16
740-0035	12-076-605	2-3/4	46.16
740-0036	12-076-626	2-3/4	46.16

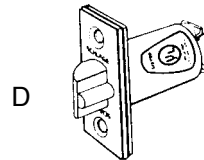

D

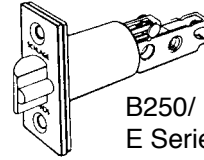

B250/
E Series

B250 Series Spring Latch, & E Series Deadlatch: \$69.30

740-0041	12-100-605	2-3/8
740-0042	12-100-626	2-3/8
740-0043	12-103-605	2-3/4
740-0044	12-103-626	2-3/4

D Series Springlatch:

740-0058	14-001 626	2-3/4"	\$66.96
----------	------------	--------	----------------

D Series Deadlatch:

740-0056	14-047-605	2-3/8	\$92.30
740-0057	14-047-626	2-3/8	92.30
740-0059	14-019-626	2-3/4	70.98
740-0061	14-028-626	3-3/4	85.02

Schlage 5 inch Backset Link for "D" Series.

Used with 2-3/4" backset latch.

740-0135	43-005 626	\$26.88
----------	------------	----------------

S. Parker Hardware

Locksets

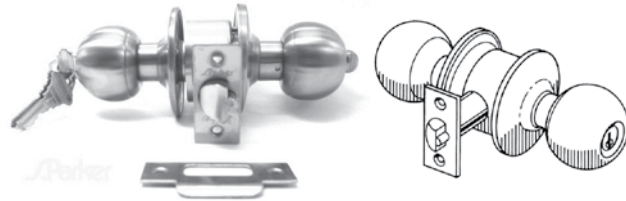

Contractor Quality Cylindrical Construction Grade 3 Locksets

Reversible for right or left handed hollow metal or wood doors from 1-1/4" to 1-3/4" thick.
 One side spin on rose, other side snap on.
 Standard with adjustable backset latch
 2-1/8" x 1" wide face plate
 4-7/8" ANSI Strike
 6-Pin cylinder, keyed to 5, SC1 keyway.

B2640 Series Locksets

Adjustable Latch, SC1 Keyway, Boxed

Order #	Item #	Function	Cat. Price
650-4020	B2648PB 03	Passage	\$24.68
650-4035	B2648AB 05	Passage	27.80
650-4005	B2648SS 32D	Passage	22.52
650-4025	B2649PB 03	Privacy	25.48
650-4040	B2649AB 05	Privacy	29.24
650-4010	B2649SS 32D	Privacy	24.52
650-4015	B2645PD 03 KD	Entry	33.42
650-4030	B2645AB 05 KD	Entry	36.64
650-4000	B2645SS 32D KD	Entry	32.24

Deadbolts

S. Parker Hardware

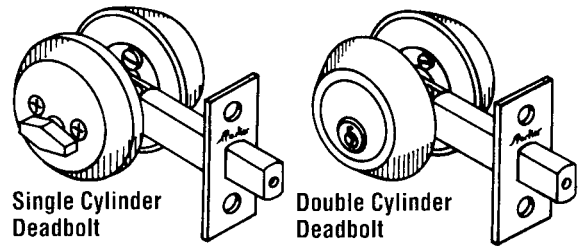

Contractor Quality Tubular Deadbolts

Adjustable backset
 2-1/8" x 1" face plate.
 1" projection bolts with an internal saw-resistant rod
 Same 6-pin keyed to 5 SC1 keyway cylinders as the knob-set above.

Deadbolts

Order #	Item #	Cylinders	Price
650-4055	93160PB 03 KD	Single	\$32.24
650-4065	93160AB 05 KD	Single	33.42
650-4045	93160SS 32D KD	Single	30.56
650-4060	93260PB 03 KD	Double	39.40
650-4070	93260AB 05 KD	Double	41.78
650-4050	93260SS 32D KD	Double	36.30

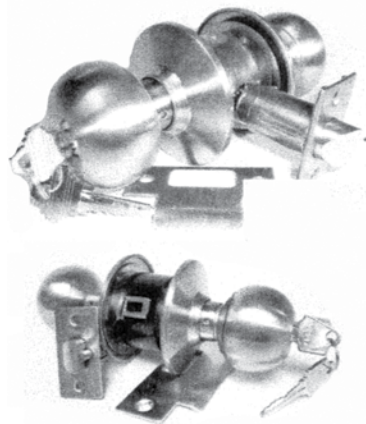

9160 Series Locksets
 Plymouth Style Grade 2, ANSI 156.2
 - Series 4000

- Backset: 2-3/4", • 2-3/4" T Strike
- Latch: 1/2" Throw

Order #	Item #	Knob	Cat.Price
650-0600	P9160 US3	Plymouth	\$57.32
650-0610	P9160 32D	Plymouth	50.06
650-0620	B9160 US3	Ball	57.32
650-0630	B9160 32D	Ball	50.06

Key-in-Lever Heavy Duty Cylindrical Locks - Grade 1

For High Frequency Traffic,
Designed to Comply with the
Handicapped Code.

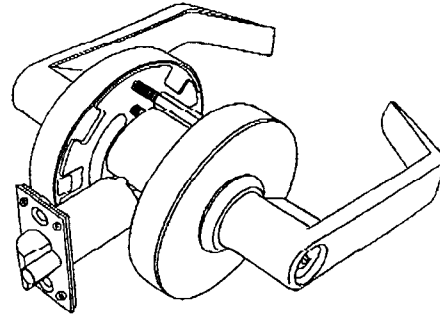

Meets security Requirements.

- Engineered with a Unique Patented Constructional Feature that eliminates possibility of lever sag.
- Exceeds ANSI Grade 1 requirements. Conforms to A117.1 Accessibility Code of the A.D.A. Meets California State Code.
- Variable Keyway, Supplied with solid brass, Schlage-C 6 pin keyway cylinder (keyed 6 pin)
- UL, UL Canada Listed, 3-hour fire rated
- Cross Reference: Schlage "D" Series

The ultimate in durability, combined with the finest construction and design, for offices, schools, hospitals, apartments, hotels, and other public buildings. This lock can be used to match up and inter-key with almost all popular brands of both commercial and residential locks and deadbolts just by substituting your "Convert-A-Lock" type cylinder with the cylinder supplied with the lock. Medeco and KABA high security cylinders will also work in these locks. Comes with Schlage C, 6-pin cylinder.

Product Specifications:

- For Doors: 1-3/8" to 2" thick.
 Backset: 2-3/4" UL Listed, A label.
 Case: Stainless Steel, steel bar and cold rolled steel, zinc dicromated for corrosion resistance.
 Trim: Lever zinc base material, plated to match finish. Roses are wrought brass or bronze.
 Keys: 2 per lock.
 Spindles: Heat treated.
 Latchbolt: Stainless steel 1/2" throw, reversible, adjustable front for flat or beveled doors 1-3/8" to 2".
 Strike: 4-7/8" x 1-1/4" ANSI strike, 1-1/4" lip to center..

LOCK FUNCTIONS:

Passage: (10) Both knobs always unlocked

Privacy: (40) Push button locking. Can be opened from the outside by small screwdriver. Turning inside knob or closing door releases button.

Entry: (53) Push & turn button to lock outside knob requires use of key until button is manually unlocked. Push button to lock outside knob until unlocked by key or by turning inside knob.

Vestibule Lock: (60) Key on both sides. Key from either side locks or unlocks both levers.

Classroom: (70) Outside knob locked & unlocked by key. Inside knob always unlocked.

Storeroom: (80) Outside knob fixed. Entrance by key only. Inside always unlocked.

Hotel Lock: (85) Outside knob fixed. Entrance by key only. Push-button in inside knob activates visual occupancy indicator, allowing only emergency masterkey to operate. Rotating inside knob or closing door releases visual occupancy indicator. Rotation of inside spanner-button provides lockout feature by keeping indicator thrown.

Order #	Item (2-3/4")	Description	Price
844-1210	DX-LHV10-US26D	Passage	\$135.48
844-1240	DX-LHV40-US26D	Privacy	145.06
844-1250	DX-LHV53-US26D	Entrance	153.62
844-1270	DX-LHV70-US26D	Classroom	154.48
844-1280	DX-LHV80-US26D	Storeroom	153.62

Incredible Value Grade 2 Leverset



Full length 5" lever handle. Same lever in all functions.
Universal push in and turn button for panic resistance.
Coil compression springs for added durability and strength.
Concealed screws for enhanced look & added security.
Keyed functions have Solid brass 6 pin cylinder and Schlage
C-keyway.

Each lever works independently of the other; separate spring
mechanisms prevent lever sag.

Standard 4-7/8" ANSI strike with all functions.

ADA Leverset

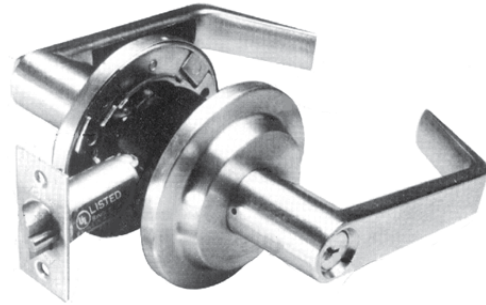

UL Listed Heavy Duty Latches

1-1/2 hour fire rated by UL.

UL and Grade 2 solid brass
bolt with 1/2" throw. 2-3/4"

backset latches have 1" x

2-1/4" face plates. 2-3/4" backset latches have 1-1/8" by

2-1/4" face plates/

DL: Deadlatch SL: Springlatch

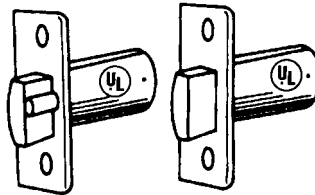

Order #	Item #	Backset	Cat. Price
650-0300	UL91000 US3 DL	2-3/4"	\$17.92
650-0310	UL93000 US3 DL	2-3/8"	17.92
650-0320	ULI91000 US3 SL	2-3/4"	17.92
650-0330	ULI9300 US3 SL	2-3/8"	17.92

Order #	Item #	Backset	Cat. Price
650-0055	UL93002 26D DL	2-3/8"	17.92
650-0056	UL91002 26D DL	2-3/4"	17.92
650-0060	UL19302 26D SL	2-3/8"	17.92
650-0061	UL191002 26D SL	2-3/4"	17.92

Grade 2. Vandal Resistant "Clutch" Cylindrical Leverset

More Features, More Quality, More Value. Meets or
Exceeds ADA/ANSI 156.2 Series 4000 Specs.

Patented Free Wheeling Design, Rotates Lever Up
and Down While Leverset Stays Locked.

Two step rose with convertible posts allows for standard
inside post installation and 2 detachable posts outside the

2-3/4" BACKSET:

Order #	Item #	Function	Price
650-0005	L7160N 26D	Passage	\$84.74
650-0010	L7160N 03	Passage	87.66
650-0011	L7160N 10B	Passage	91.28
650-0015	L7160P 26D	Privacy	85.88
650-0020	L7160P 03	Privacy	85.58
650-0021	L7160P 10B	Privacy	91.94
650-0025	L7160A 26D	Entry	93.58
650-0030	L7160A 03	Entry	93.58
650-0031	L7160A 10B	Entry	104.82
650-0035	L7160D 26D	Storeroom	93.58
650-0040	L7160D 03	Storeroom	93.58
650-0041	L7160D 10B	Storeroom	103.36
650-0045	L7160R 26D	Classroom	98.70
650-0050	L7160R 03	Classroom	98.70

2-3/8" BACKSET:

Order #	Item #	Function	Price
650-0004	NSP L210-26D	Passage	\$84.74
650-0014	NSP L240-26D	Privacy	85.88
650-0024	NSP L250-26D	Entry	93.58
650-0034	NSP L280-26D	Storeroom	93.58

2-1/8" cutout (#161 door prep) for an extra secure instal-
lation. Non-handed.

Solid brass 6 pin SC-1 cylinder (keyed to 5 pin).

Clutch Leversets,

2-3/4" BACKSET:

Order #	Item #	Function	Price
650-0100	CL7160A-26D	Entry	\$127.58
650-0103	CL7160A-03	Entry	127.58
650-0120	CL7160D-26D	Storeroom	127.58
650-0140	CL7160R-26D	Classroom	137.42
650-0143	CL7160R-03	Classroom	137.42

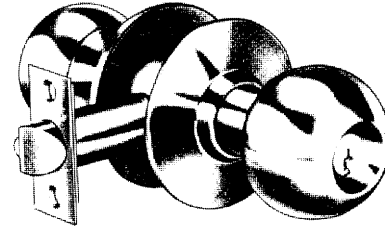
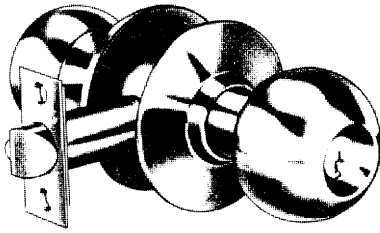

SV Series Deluxe Cylindrical Locks

For Commercial Buildings & Residential Use

Lock can be used to match up and inter-key with almost all popular brands of both commercial and residential locks and deadbolts just by substituting the Ilco Key-in-knob cylinder with the cylinder supplied with the lock *. (Cylinders extra, see Replacement Cylinders Section.) Medeco and KABA high security cylinders will also work in these locks.

- Ball Knob (2-1/8" dia.)
- Variable Keyway, supplied with Schlage "C" 6 pin keyway cylinder (keyed 6 pin)
- ANSI A.156.2, Series 4000, Grade 2.
- **Cross Reference:** Schlage "A", Sargent "6 line", Corbin "5600", Russwin "3300", PDQ "SV", Yale "5300", Falcon "E".
- **Door Prep:** 2-1/8" cross bore, 1" end bore.
- **Door Thickness:** 1-3/8" & 1-3/4" • **Keys:** 3 per lock
- **Latch:** Deadlocking on key functions. Solid brass with 1/2" throw.

Material: All trim wrought stainless steel or brass, chassis and latch cases are steel, zinc chromate plated, resists corrosion.

Order # 2-3/8"	Order # 2-3/4"	Item	Function	Price
844-1011	844-1010	SVB10-US32D	Passage	\$30.90
844-1015	--	SVB10-US3	Passage	33.22
844-1041	844-1040	SVB40-US32D	Privacy	40.32
844-1045	--	SVB40-US3	Privacy	40.32
844-1051	844-1050	SVB53-US32D	Entry	44.30
844-1055	--	SVB53-US3	Entry	49.84
844-1061	844-1060	SVB60-US32D	DbI Cyl	77.52
844-1071	844-1070	SVB70-US32D	Classroom	47.06
844-1081	844-1080	SVB80-US32D	Storeroom	44.30
844-1085	--	SVB80-US3	Storeroom	49.84

* NOTE: ILCO cylinders will not work in Double Cylinder locksets (60 Series)

Heavy Duty Cylindrical Locks HV SERIES, For High Frequency Traffic

The ultimate in durability, combined with the finest construction and design, for offices, schools, hospitals, apartments, hotels, and other public buildings. This lock can be used to match up and inter-key with almost all popular brands of both commercial and residential locks and deadbolts just by substituting the Ilco Key-in-knob cylinder with the cylinder supplied with the lock*. (Cylinders are extra, see Replacement Cylinders Section.) Medeco and KABA high security cylinders will also work.

- ANSI Grade 1 • Ball Knob (2-3/16" dia)
- Variable Keyway, Supplied with Schlage-C, 6 pin keyway cylinder (keyed 6 pin)
- UL Listed A Label
- Complies with ANSI A156.2 Series 4000 Grade 1
- Cross Reference: Schlage "D" Series

Product Specifications:

- **For Doors:** 1-3/8" to 2" thick.
- **Backset:** 2-3/4" UL Listed, A label.
- **Case:** Corrosion treated heavy gauge, cold-rolled, steel mechanisms.
- **Trim:** Knobs & roses are stainless steel, brass or bronze.
- **UL Listing:** "A" label (3 hour) single swing doors (4' x 8').
- **Keys:** 2 per lock. • **Spindles:** Heat treated.
- **Latchbolt:** Solid brass 1/2" throw, reversible,
- **Strike:** 4-7/8" x 1-1/4"

Order #	Item (2-3/4")	Function	Cat Price
844-1110	S-HVB10-US32D	Passage	\$104.40
844-1140	S-HVB40-US32D	Privacy	130.50
844-1150	S-HVB53-US32D	Entrance	142.12
844-1160	S-HVB60-US32D	Double Cyl	191.64
844-1170	S-HVB70-US32D	Classroom	142.12
844-1180	S-HVB80-US32D	Storeroom	149.18



NATIONAL SECURITY PRODUCTS
Quality & Value, the Professionals Choice



**DX-LSV Series
Cylindrical
Construction**

ANSI Grade 2

Key-In-Lever Lock

2-3/4" Backset,
Schlage 6-pin "C" keyway.

For doors 1-3/8" to 1-3/4" thick. Not thru-bolted.

ANSI A156.2, Series 4000, Grade-2. Complies with provision of Title 19, California State Fire Marshall.

US26: Bright Chrome US3: Bright Brass
US26D: Brushed Chrome US10B: Oil Rubbed Bronze

See Function List to the right . . .

Order #	Item #	Catalog Price
844-2045	(U) DX-LSV80R US3	94.90

(U) Available while they last.

US10B: Oil Rubbed Bronze, 2-3/4" Backset

Order #	Item #	Price	Function
650-0150	(U) SL8160N 10B	\$98.46	Passage
650-0155	(U) SL8160P 10B	107.82	Privacy
650-0160	(U) SL8160A 10B	116.22	Entry
650-0165	(U) SL8160D 10B	116.22	Storeroom

Now with "Clutch" function.

Lever rotates before it breaks. With posts. 2-3/4" backset.

Order #	Item #	Catalog Price
844-2200	CL-DX-LSV53R US26D	\$113.36
844-2220	CL-DX-LSV70R US26D	125.22
844-2240	CL-DX-LSV80R US26D	113.36

**Now With VENUS
Design Lever**

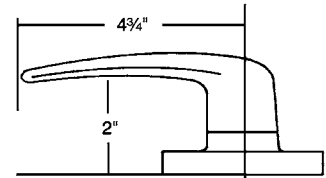

Order #	Item #	Catalog Price
844-2300	DX-LSV10R US26D	\$83.72
844-2310	DX-LSV10R US3	74.74
844-2320	DX-LSV40R US26D	84.30
844-2330	DX-LSV40R US3	84.30
844-2340	DX-LSV53R US26D	94.90
844-2350	DX-LSV53R US3	94.90
844-2360	DX-LSV70R US26D	97.54
844-2370	DX-LSV70R US3	97.54
844-2380	DX-LSV80R US26D	97.54
844-2390	DX-LSV80R US3	97.54

FUNCTIONS:

- 10: Passage.** Both levers always free.
- 40: Privacy.** Push button locking. Can be opened from outside with narrow blade tool.
- 53: Entry.** Push button locking. Pushing button on inside locks outside lever until unlocked by key or by using inside lever.
- 70: Classroom.** Outside lever locked or unlocked by key from outside. Inside lever always free.
- 80: Storeroom.** Outside lever rigid. Entry by key only. Inside lever always free.

**ICL Series for
Best
Interchangeable
Core Cylinder**

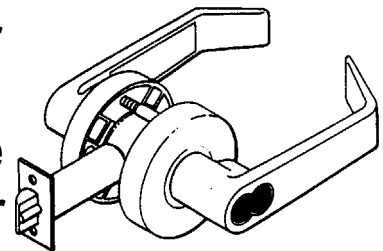

ANSI Grade 2 Cylindrical Lock

Specs same as DX-LSV Series, except:
All locks supplied with thru-bolt feature.

Retrofits all 6-7 pin IC core Best type cylinders including Arrow IC cylinders with same configuration as Best.
Cylinder not included. Catalog Price: **\$94.90 Each**

Order #	Item #	Function
844-2125	NSP ICL80R US3	Storeroom

(U) These are available while supplies last.

Narrow Stile Locks

For use with Mortise Cylinders, Lever Handles, Push Paddles
1 x 5-13/16" Case size.

Cylinders not included.

Available with either of two color faceplates:

- ALL Satin Aluminum,
- DURL Duronodic/ Brown

Heavy Duty DEADLATCH

This lock can be locked in a "hold-open" position. It is ideal for use during heavy traffic flow and will allow two way traffic in buildings that require a free two way entrance at times and an "exit only" at other times. Cylinder not included.

31/32: \$34.04; 1 1/8": \$35.58

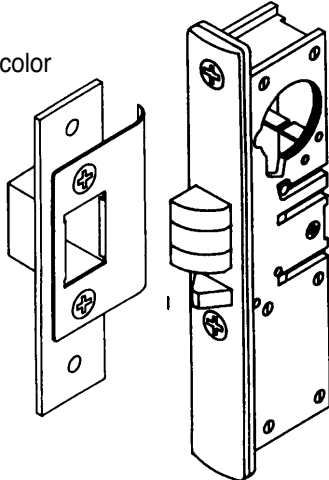

Order #	Item #s	Backset
844-0001	DX-DL4710 (N6201ALL)	31/32
844-0005	DX-DL4710 (N6201DURL)	31/32
844-0010	DX-DL4711 (6201ALL)	1-1/8
844-0015	DX-DL4711 (6201DURL)	1-1/8

DEADLOCK

A 360° turn of the key (or thumb turn) throws or retracts the counterbalanced bolt. The can can then be removed only when the bolt is in a positive locked or unlocked position. The lock accepts any standard 1-5/32" mortise cylinder (with M.S. cam) from either or both sides. Cylinder not included.

31/32: \$34.04; 1 1/8": \$ 35.58

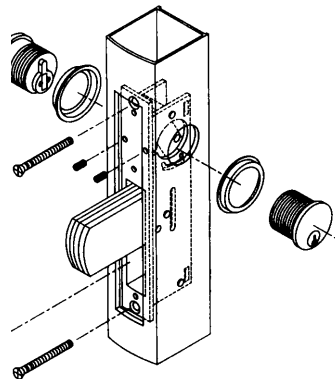

Order #	Item #s	Backset
844-0020	DB3231 (N6202LCAL)	31/32
844-0025	DB3231 (N6202LCDUR)	31/32
844-0030	DB3236 (6202LCAL)	1-1/8
844-0035	DB3236 (6202LCDUR)	1-1/8



HOOK-TYPE DEADLOCK

Cylinder not included.

31/32: \$34.04; 1 1/8": \$35.58

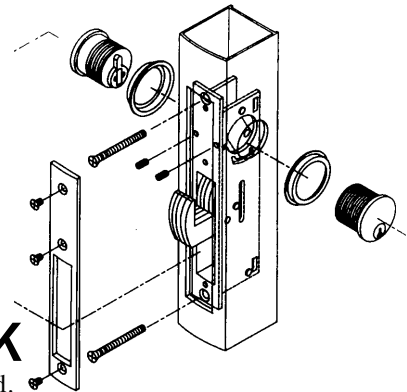

Order #	Item Nos.	Backset
844-0040	HB3231 (N6202HLCAL)	31/32
844-0045	HB3231 (N6202HLCDUR)	31/32
844-0050	HB3236 (6202HLCAL)	1-1/8
844-0055	HB 3236 (6202HLCDUR)	1-1/8

LEVER HANDLE

For use with Deadlatch. Reversible (LH or RH)

Complete with operating cam plug which will activate narrow stile dead latches. Cam plug is secured to lever unit assembly by two hardened steel pins. Cam plug locks into dead latch like mortise cylinder by use of set screw in dead latch.

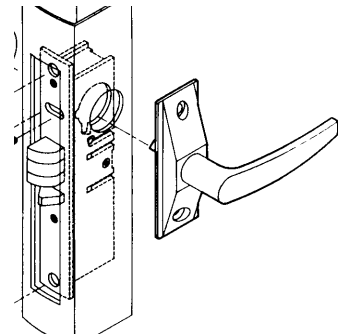

844-0060	HL4560 (LP6201ALL)	\$34.04
844-0065	HL4560 (LP6201DURL)	34.04

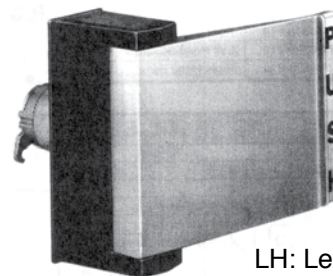

Paddles

AL: \$64.74 each
Duro: \$60.50 ea
Order Correct Hand

LH: Left Hand
RH: Right Hand

PADDLES

Order #	Hand	Item #	Finish
844-0110	RH	S-E-PP496	Aluminum
844-0115	RH	S-E-PP496	Duronodic
844-0111	LH	S-E-PP497	Aluminum
844-0116	LH	S-E-PP497	Duronodic

Powerbolt™

Electronic KEYLESS Entry System

**WEISER
LOCK™**

Security

Heavy-duty deadbolt security; Safe, quick access when it's dark

4 - 8 digit personal security code

Personal code set at digit pad controls with activation through security access cover

Automatic code-break alarm system

Personal code can be changed easily and as often as necessary

Includes mechanical key back-up

Convenience

Keyless entry convenience - no more accidental lockouts with lost or forgotten keys

Fast, convenient access during bad weather; Easy one-touch locking

Two code capacity allows convenient temporary access for contractor service crews

Easily replaces existing door hardware and fits standard preparation on new doors

Battery operated - no hard wiring required (add 4 standard AA batteries)

Brilliance Finish on all exterior surfaces;

Adjustable Backset.

Attractive easy to use digit pad design



Deadbolt Only

Order #	Item #	Price
940-3003	ED1460X US3	\$223.92
940-3005	ED1460X US5	223.92
940-3026	ED1460X 26D	223.92

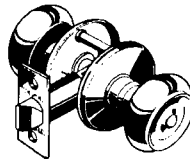

Passage Set for Powerbolt.

Phoenix design, brilliance finish

940-3503	NA100P 3BR	\$34.20
940-3526	NA100P 26DBR	\$34.20

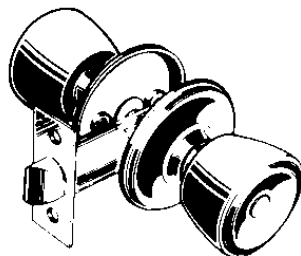
**WEISER
LOCK™**

Beverly

A Series Standard Duty

- Adjustable Backset
- 2-1/8" diameter door face hole
- 1" diameter latch hole
- Automatic adjustment to door thickness of 1-3/8" to 1-3/4".
- ANSI A156.2, Series 4000, Grade 3 lock. UL Listed.

Beverly Knobs in US5

ITEM	ORDER #	\$
WEI-NA100B-US5	940-1005	30.72
WEI-NA330B-US5	940-1033	35.16
WEI-NA500DLB-US5	940-1049	62.04
WEI-NA530DLB-US5	940-1064	62.04
WEI-NA580DLB-US5	940-1086	79.08

Beverly Knobs

WEI-NA100B-US3	940-1001	27.24
WEI-NA100B-26D	940-1003	27.24
WEI-NA160DLB-26D	940-1020	46.92
WEI-NA330B-US3	940-1029	32.04
WEI-NA330B-26D	940-1031	32.04
NA500BDL-26D	940-1045	57.96
NA530BDL-US3	940-1056	57.96
NA530BDL-26D	940-1062	57.96
adj. backset		
NA580BDL-US3	940-1082	75.48
NA580BDL-26D	940-1084	75.48

Basic Series Knobsets

High quality, low cost.

Furnished with
2-3/8" backset.

(U) Available while
supplies last.

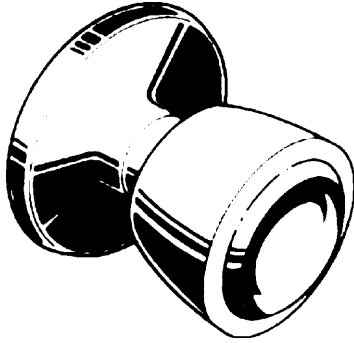

WEISER LOCK™

Richmond (R)

ITEM	ORDER #	\$
NAC330R-US3	(U) 940-0620	22.44
NAC330R-26D	(U) 940-0625	22.44
NAC330R-US5	(U) 940-0630	25.44

(U) These are available while supplies last.

FUNCTIONS

- 100... **HALL/CLOSET.** Latch bolt operated by knob from either side; both knobs always free.
- 160 ... **Connecting Exit Lock.** Deadlocking latch bolt operated by free turning knob inside. Blank plate outside.
- 300... **BED/BATH.** Push and turn knob locking inside; knob with emergency release opening outside.
- 330... **BED/BATH.** Turn button locking inside; knob with emergency release opening outside.
- 500... **FRONT/BACK LOCKSET.** Keyed knob outside; push and turn knob locking inside; deadlocking latch.
- 530... **FRONT/BACK LOCKSET.** Keyed knob outside; push and turn button locking inside; deadlocking latch.
- 580... **STOREROOM.** Keyed knob outside; outside knob always rigid; inside knob always free; deadlocking latch.

Basic Series

Dead Bolts

High quality, Low cost.
Adjustable backset.

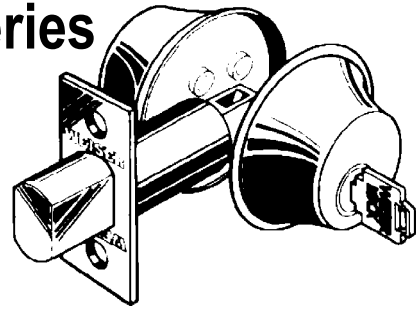

Double Cylinder:

Item #	Finish	Order #	Cat. Price
WEI-NDC9370L-26D		(U) 940-0805	45.60

(U) These are available while supplies last.

IT'S A
LOCKSET PLUS
DEADBOLT
IN ONE.

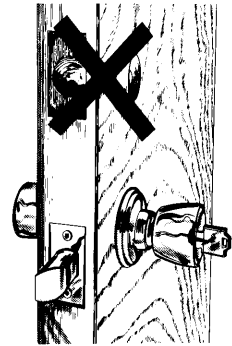

WEISERBOLT

Built-in 1" Deadbolt. For "in"
or "out swinging" doors,
adjustable backset.

Order #	Item	Price
940-1132	NDA5170B-US3	\$110.52

Weiser Finishes

US3: Bright Brass
5E: Etched Brass
US5: Antique Brass

US7: Ebony Black
26D: Satin Chrome

Lifetime Weiser Brilliance finish

Weiser Brilliance is the standard **EXTERIOR** finish on the following products:

- NA & NLA Series Keyed Entry Knobsets
- ND9000 and 4000 Series Keyed Deadbolts
- WeiserBolt Knobsets and Handlesets
- NA and NLA Series Handlesets.

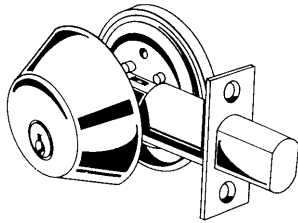

WEISER LOCK™

Heavy Duty

D9000X Series

Furnished with adjustable backset. 2-3/8" or 2-3/4".
(DIB= Drive-in-bolt.)

Single Cylinder:

Item #	2-3/8	2-3/8 DIB	Price
ND9470X-US3	940-1239	940-1241	\$54.72
ND9470X-US5	940-1247	940-1249	53.16
ND9470X-26D	940-1259	940-1261	54.72

Double Cylinder:

Item #	2-3/8	2-3/8 DIB	Price
ND9370X-US3	940-1215	940-1217	77.76
ND9370X-US5	940-1223	940-1225	75.60
ND9370X-26D	940-1235	940-1237	77.76

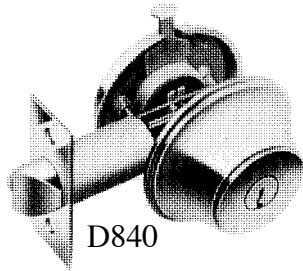

D840

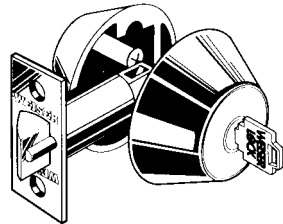

830

Gate Locks

2-3/8 Backset.

Single Cylinder with Deadlocking Latch

Key outside, thumbturn inside. Has hold back feature.

Item - Finish	Order #	Cat. Price
ND840X-US3	940-1148	\$105.60
ND840X-26D	940-1149	105.60

Double Cylinder with Deadlocking Latch

Latchbolt is operated by key from either side.

Item #	Order #	Price
ND830X-26D	940-2130	\$143.28

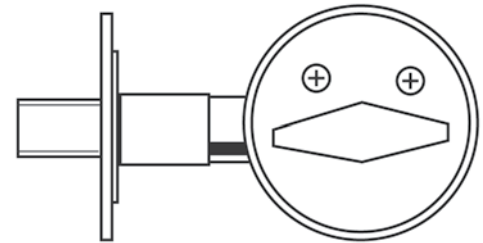

9670

Connecting Door Deadbolt, Turnbolts

Half door bore 1-1/2" diameter face hole only. Nothing on exterior of door. Deadbolt operated by thumb turn on interior of door. Adjustable 2-3/8" or 2-3/4" backset.

Order #	Item #	Price
940-2115	WEI-ND9670H-US3	\$28.32
940-2120	WEI-ND9670H-26D	28.32
940-2125	WEI-ND9670H-US5	31.56

Thumbturn x Blank Plate

Order #	Item #	Price
940-2110	WEI ND9670M-26D	\$32.88

Indicator Deadbolts

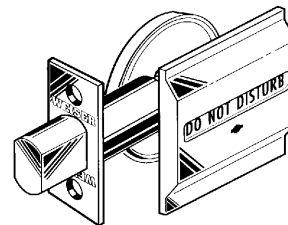

9770

Emergency Key
for Indicator Deadbolt:

940-9159	\$2.40
----------	---------------

	Message When Locked (Red Panel)	Message When Unlocked (Green Panel)
9158	DO NOT DISTURB	Plain
9158-2	OCCUPIED	VACANT

Adjustable Backset.

Item #	Message	Order #	Price
ND9770-26D	9158	940-1287	\$57.84
ND9770-26D	9158-2	940-1288	57.84



**Adjustable Bolts
for Both 9470 & 9370
Deadbolts.**

Single & Double Cylinder

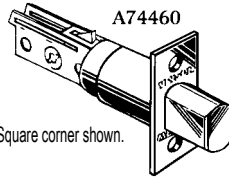

Note: Square corner shown.

Order #	Item #	Description	Price
940-0143	A76469-US4	Drive-In Bolt	\$19.68
940-0142	A74461-26D	1/4" radius face	19.68
940-0140	A74461-US4	1/4" radius face	19.68

840DL Latch Bolt:

940-0201	62435DL-26D	2-3/4	\$15.60
----------	-------------	-------	----------------

**Universal
Dead Latch**

Adjustable latch for any
A, LA, or ML Series Lock.

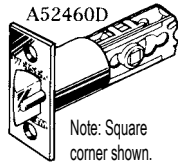

Note: Square corner shown.

- 1) 2-3/8" backset with 1/4" radius corner
- 2) 2-3/4" backset with 1/4" radius corner

Order #	Item #	Type	Price
940-1466	A52461D-US3	Deadlocking	15.60
940-1450	A52461D-26D	Deadlocking	15.60
940-1460	A52461-US3	Spring Latch	14.76
940-1470	A52461-26D	Spring Latch	14.76

**Adjustable Deadlatch
Drive-In-Latch.**

940-0139	A50469D-US4	\$15.60
----------	-------------	----------------

**Weiser-Bolt
NDA Series.**

Adjustable WeiserBolt latch
must be used with new angle lip strike.

Square corner. **\$26.16 Each**

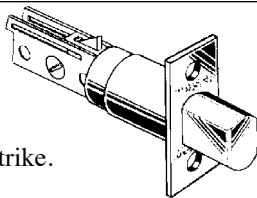

Order #	Item #	Backset	Door
940-0220	A64460-26SP	ADJ	Inswinging
940-0221	A64460-4SP	ADJ	In or Out

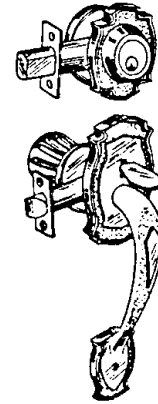

**Standard Duty.
A9000 Series Deadbolt**

2-3/8" Backset.

Aristocrat trim on inside.

HIGH POINT
HPT

SINGLE CYLINDER:

940-1146	NA9470HPB US3	\$274.32
940-1147	NA9470HPA-US5	245.04



**Single Cylinder
Handlesets**

Augusta, US 3 finish

Order #	Item #	Price
940-1141	WEI NA9470P	\$257.28

AUGUSTA
AUG



Dummy Handleset Trims

Order #	Item #	Trim	Finish	Price
940-1139	WEI NA77P	AUG	US3	228.48

LEVER DESIGNS

5400LN

Augusta AU

AU Lever: Cast Solid
Rose: Cold forged Brass, Bronze

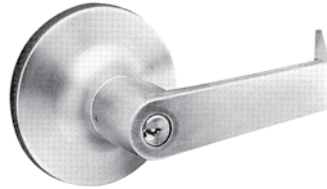
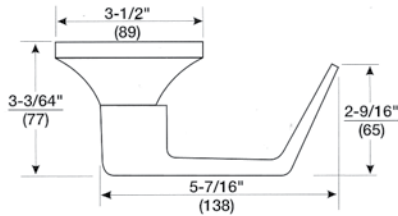

AU

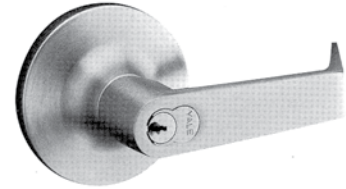

AU**

Monroe MO

MO Lever: Cast Solid
Rose: Cold forged Brass, Bronze

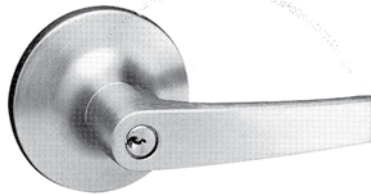
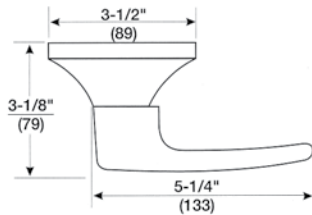

MO

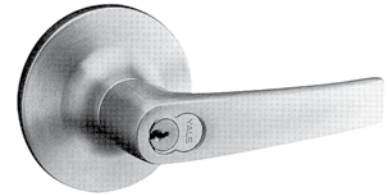

MO**

Pacific Beach PB

PB Lever: Cast Solid
Rose: Cold forged Brass, Bronze

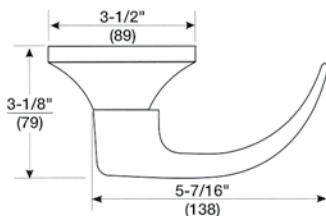

PB

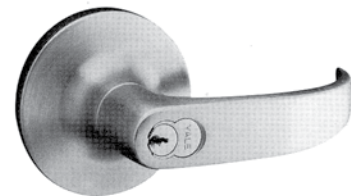

PB**

Dimensions are shown in Inches (Millimeters).

See page 8 and 9 for interchangeable core cylinder order options.

LOCKSET FUNCTIONS

5401LN

F75

Passage or Closet Lock

- For doors that do not require locking.
- Either lever operates latchbolt at all times.

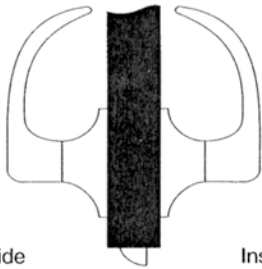

Outside

Inside

5402LN

F76

Privacy Bedroom or Bath Lock

- For lavatory or other privacy doors.
- Either lever operates latchbolt unless outside lever is locked by pushbutton inside.*
- Button automatically releases when inside lever is turned or door is closed.
- Emergency release in outside lever. Emergency key supplied. (PN 14-5302-1053-048)
- Inside lever always active.

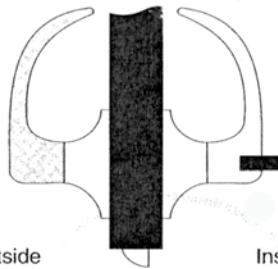

Outside

Inside

5400LN

5403LN

F77

Patio or Privacy Lock

- For exit doors with limited entry.
- Deadlocking latchbolt.
- Either lever operates latchbolt unless outside lever is locked by pushbutton inside.*
- Button automatically releases when inside lever is turned or door is closed.
- Inside lever always active.

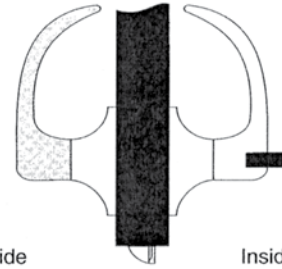

Outside

Inside

5404LN

F82

Entry Lock

- For entrance or office doors.
- Deadlocking latchbolt.
- Either lever operates latchbolt (except when outside lever is locked from inside).*
- Pushing button in inside lever locks outside lever. (Automatically releases when inside lever is turned or key is rotated in locked outside lever.)
- Latchbolt is operated by key in outside lever or by rotating inside lever.
- Inside lever always active.

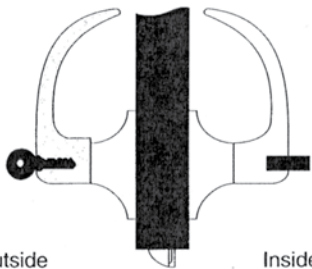

Outside

Inside

5405LN

F86

Storeroom or Closet Lock

- For use on storeroom, utility, exit doors.
- Deadlocking latchbolt.
- Latchbolt operated by lever inside, key in outside lever.
- Outside lever always locked.*
- Inside lever always active.

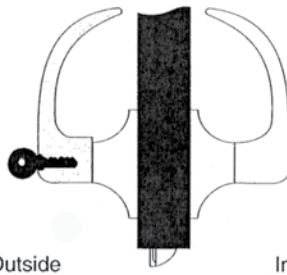

Outside

Inside

5406LN

F92

Service Station Lock

- Deadlocking latchbolt.
- Either lever operates latchbolt.
- Pushbutton in inside lever locks outside lever. (Automatically releases when inside lever is turned, door is closed or key is rotated in outside lever, except when slotted pushbutton is rotated 90° clockwise to retain outside lever in locked position.)*
- Latchbolt operated by key in outside lever, inside lever always active.

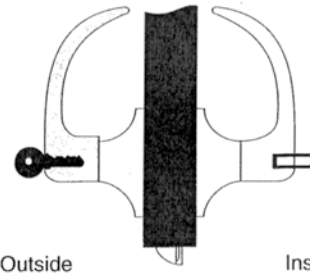

Outside

Inside

* Lever handles are Free Wheeling in locked position. Shaded area denotes Free Wheeling lever.

5407LN

F81/F82

Entrance or Corridor Lock

- For entrance, general home or office doors.
- Deadlocking latchbolt.
- Either lever operates latchbolt (except when outside lever is locked from inside).*
- Pushing turn button in inside lever locks outside lever, and automatically releases when inside lever is turned or key is rotated in locked outside lever.

- Outside lever may be retained in locked position by pushing and rotating turn button 90° clockwise to a horizontal position; not released until turn button is manually returned to the vertical position.
- Latchbolt is operated by key in outside lever or by rotating inside lever.
- Inside lever always active.

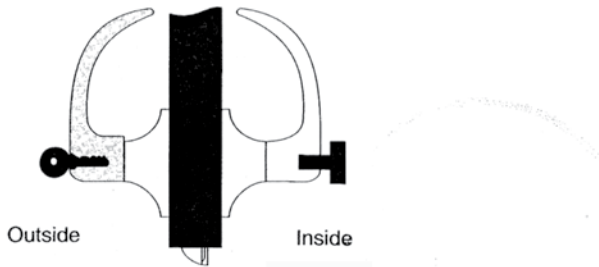

5408LN

F84

Classroom Lock

- For classroom or utility room doors.
- Deadlocking latchbolt.
- Either lever operates latchbolt (except when outside lever is locked by key).*
- Inside lever always active.
- Outside lever locked* or unlocked only by key.

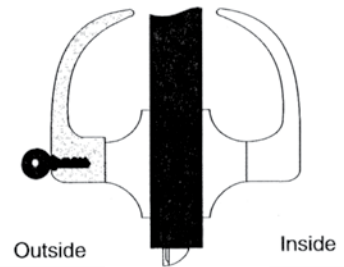

5409LN

F89

Exit Lock

- For exit doors with no-entry desired.
- Deadlocking latchbolt.
- Outside lever always locked.*
- Inside lever always active.

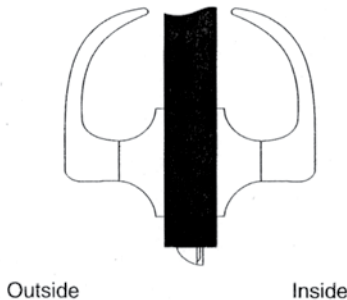

5417N

F88

Apartment, Exit or Public Toilet Lock

- For office or apartment building entrance doors or lavatory doors.
- Deadlocking latchbolt.
- Either lever operates latchbolt (except when outside lever is locked by key from inside).*
- Key in outside lever operates latchbolt.
- Inside lever always active.

NOTE: Inside handle requires 1802S standard 6-pin cylinder.

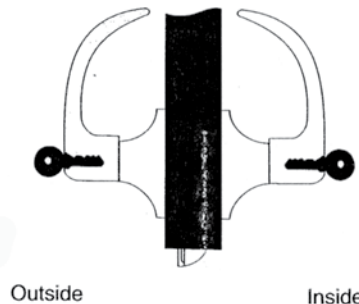

5421LN

F80

5421LN Communicating Lock

- For communicating or store entrance doors.
- Deadlocking latchbolt.
- Either lever operates latchbolt (except when key in either lever locks or unlocks the lever independently of the other).*
- Should be used only in offices or rooms with multiple entries.

NOTE: Not available with I.C. core cylinders.

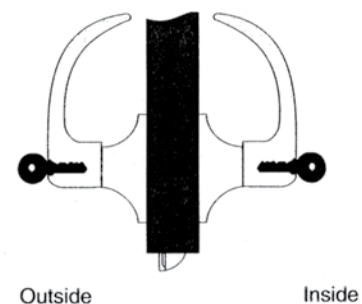

* Lever handles are Free Wheeling in locked position. Shaded area denotes Free Wheeling lever.

5422LN

F90

Dormitory Lock

- Deadlocking latchbolt.
- Either lever operates latchbolt (except when outside lever is locked by inside pushbutton or key in outside lever).* Inside lever always active.
- When locked by button, the button automatically releases when inside lever is turned or door is closed.
- When locked by key, the automatic release is made inoperative and must be manually unlocked by the key.*

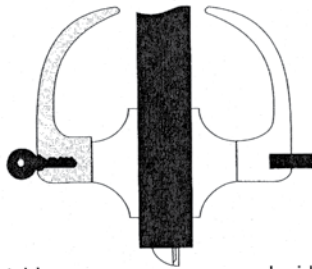

Outside

Inside

5425LN

F90

Privacy Lock

- For lavatory or other privacy doors.
- Either lever operates latchbolt (except when outside lever is locked by inside pushbutton).*
- Button automatically releases by turning inside lever or closing door.
- Door can be unlocked, when necessary, by operating outside turnbutton.
- No emergency key required.

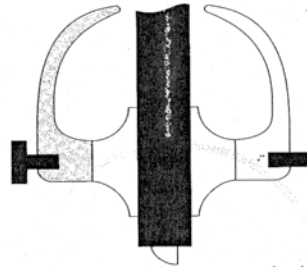

Outside

Inside

5428LN

Exit Latch

- For twin communicating or exit doors where one side operation is required.
- Use where space is limited.
- Deadlocking latchbolt.
- One lever operation.
- Blank rose.
- Should be used only where rooms have more than one entrance.

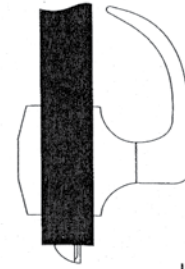

Outside

Inside

5429LN

Communicating or Closet Lock

- For twin communicating or closet doors where one side operation or space between doors is limited.
- Deadlocking latchbolt.
- Inside lever operates latchbolt except when lever is locked by key.*

(Not available with I.C. core cylinders.)

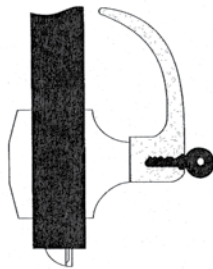

Outside

Inside

5430LN

F87

Utility, Asylum or Institutional Lock

- Deadlocking latchbolt.
- Latchbolt operated by key in lever from either side.
- Both levers always locked.*

(Not available with I.C. core cylinders.)

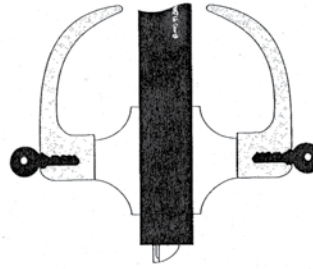

Outside

Inside

455LN

Dummy Trim

- For non-operational levers use for decorative trim.

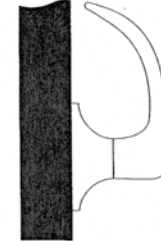

Outside

Inside

* Lever handles are Free Wheeling in locked position. Shaded area denotes Free Wheeling lever.

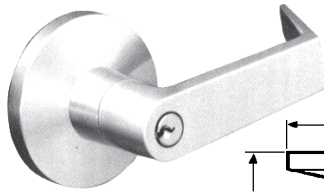

Yale

Heavy Duty Cylindrical Key-in-Lever

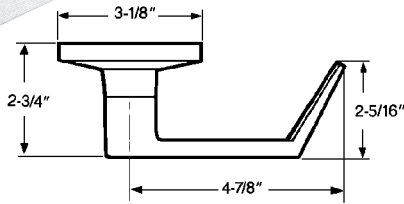

Lock mechanism is constructed of heavy gauge cold rolled steel; all parts are zinc-plated and dichromated to assure maximum protection from rust or corrosion. Recommended for use under normal climatic and environmental conditions. For metal doors 1.75" to 2.25"; wood or mineral core doors 1.75" standard. 2.75" backset, reversible. Yale 8 Keyway. ANSI Spec. A156.2, Series 4000, Grade 1, can be installed on doors prepared to ANSI Specs. A115.2.

Order #	Item #	Cat. Price
755-0238	AU5407L US26D	\$453.20

For Interchangeable Core, 7 pin

(Cores not included):

Order #	Item #	Function	Price
755-0240	AU5407LN-1220 US26D	Interior	\$455.40
755-0241	AU5407LN-1220 US10B	Interior	455.40
755-0210	AU5408LN 1220 US26D	Classroom	455.40
755-0220	AU5405LN 1220 US26D	Storeroom	455.40
755-0230	AU5404LN 1220 US26D	Entrance	455.40

Yale

Lockset, Less Cylinder

755-0245	AU5408LN-626-LC	\$398.20
----------	-----------------	----------

Deadlocking Latch Bolts.

5300 Series:

755-0251	380N-26D	2-3/8	\$43.40
755-0253	380AN-26D	2-3/4	43.40
755-0254	380AN-US3	2-3/4	43.40

5400 Series:

755-0255	480-26D	2-3/4	93.80
----------	---------	-------	-------

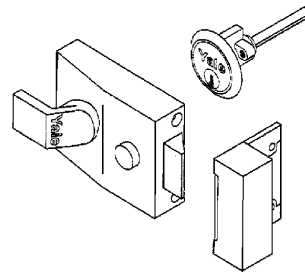
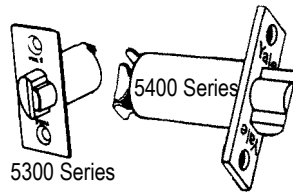

YALE

Rim Deadlocks 88 Series

2-3/8" Backset. **Replace the #36** . Its securing bolt can be held back by the slide button and also projected into its extended position in the strike by the slide button.

Order #	Item #	Cat.Price
755-0179	Yal 88 (Old #36)	\$60.00

#80 Security Latchlock

755-0180	#80	\$60.00
----------	-----	---------

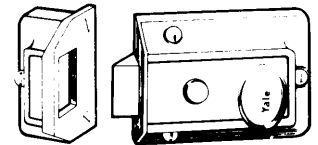

#112 Heavy Duty Boltlock

1-1/8" throw deadlock.

Key outside, thumbturn inside.

Order #	Item #	Cylinders	Price
755-0181	112	Single	\$99.60
755-0360	112F	Single	99.60
755-0182	112-1/4	Double	116.40

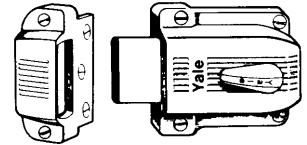

Jimmy Proof Rim Locks

#197 Heavy Duty Boltlock

Key outside, thumbturn inside.

Steel interlocking bolts resist prying.

Order #	Item	Cylinder	Price
755-0183	197	Single	\$99.60
755-0184	197F	Single	99.60
755-0185	197-1/4	Double	116.40
755-0186	197F-1/4	Double	116.40

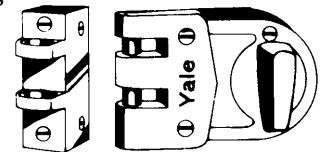

"F" Denotes Flat Strike.

Parker Hardware mfg. corp.

Your Best Source For
Quality Door Hardware
Since 1899

Greatly IMPROVED Profits with Greatly REDUCED Costs!



#441 Closer

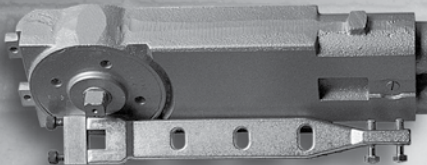

#400 Concealed Closer



#EL520
Exit Trim

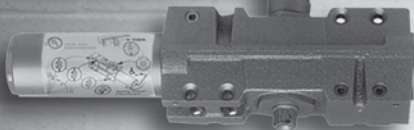

#525
Architectural
Panic Device

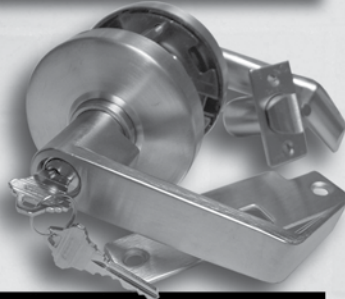

#C8161 Grade 1 Lever

GRADE
1



#540 Narrow Stile
Exit Device



Grade 1 Mortise Locks
Quick Change Handing



Your IC Core
Hardware Headquarters!

Value Engineered – Quality Guaranteed!