

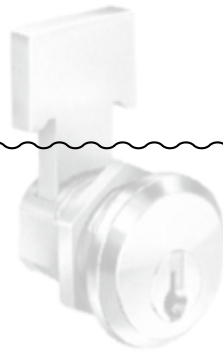

# CABINET LOCKS

## SECTION 2



### Index

#### A

Ace/Tubular Locks 8, 10

#### C

Cabinet Locks 19, 20

Cam Locks 7, 8, 10, 12, 16,  
17, 20, 23

Chest Locks 16

Combination Cam Locks 10, 12

Cooler Locking Handles 17

#### D

Drawer Locks 7, 9, 11, 14,  
15, 18, 19, 22

Dust Covers 11

#### E

Electronic Cabinet Locks 13

eLock 13

#### F

File Cabinet Locks 3, 4, 5

Furniture Locks 16

#### G

Gang Locks 15, 23

#### H

Handle Cylinders 8

Handle Locks 9, 16, 17, 18

#### I

Illinois Lock 3

#### L

Letter Box Locks 24

Lock Housings 18

Locking Bars 5, 6

Lock Plugs 21

#### M

Mailbox Locks 24, 25

Metal Drawer Locks 7, 14

#### P

Panel Board Locks 9

Postal Locks 24

Push Locks 2, 23

#### R

Refrigerator Locks 13

#### S

Screw Type Locks 8

Showcase Locks 10

Sliding Door Locks 2

Sliding Door Ratchet Locks 20

Spur Washers 11

Swing-Away File Bars 5

#### T

Thick Panel Locks 22

Thumbturn Locks 7

## CABINET LOCKS

#### V

##### Vendors

ABUS 5

BOMMER 25

CCL 9, 10

COMPX 12, 13

COMPX: Chicago 3, 8

COMPX: Fort 10, 11

COMPX: National 2, 14, 15,  
16, 17, 18, 24, 25

COMPX: Timberline 21, 22, 23

ESP 3, 7

GUARD 24

HPC 5

ILCO 11

ILLINOIS LOCK 3

KABA ILCO 6, 24

MAJOR 6

NSP/ESP 3, 7

OLYMPUS 2, 18, 19, 20

PROGRAMMED MKGT 2, 25  
(Husdon)

S. Parker Hardware 2, 18

SRS SALES 4, 5

TACO 24

**PUSH LOCKS**

**CABINET LOCKS**

**PUSH LOCKS**



**OLYMPUS LOCK INC.**

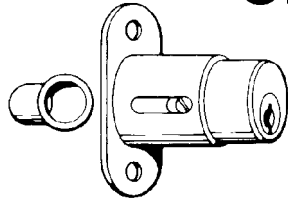

02291

OLYMPUS

**02290, 02291.** Push Bolt Type. To lock, push end of cylinder. To unlock, use key. Keys: 5862C-R1 (02290), 8618C-R1 (02291)

**02293.** To lock, push in cylinder and turn counter-clockwise with key. To unlock, turn clockwise with key. End of bolt locks behind strike which prevents doors from being spread apart. For protection of doors, bolt is locked in both in and out positions.

Order Key Blank: 200-0120 (CCL 8618C-R1)

**Push Locks**

7/8" Cylinder Length  
For 7/8" material thickness

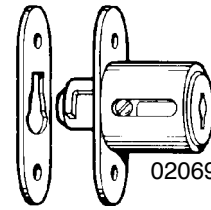

02069

**Sliding Door Lock: Pin Tumbler**

Item #	Cyl. Dia.		
OLY 02291/400SD US4	1"	200-0580 KA	<b>54.12</b>
OLY 02291/400SD US4	1"	200-0581 KD	<b>54.12</b>
CCL 02290 US4	7/8"	200-0578 KA	<b>60.80</b>
CCL 02290 US4	7/8"	200-0579 KD	<b>60.80</b>

**Locking Strike Type: Disc tumbler.**

CCL 02069 US4	7/8"	200-0569 KA	<b>21.64</b>
CCL 02069 US4	7/8"	200-0571 KD	<b>21.64</b>

**CompX NATIONAL**

COMPX: National

**Pin Tumbler**

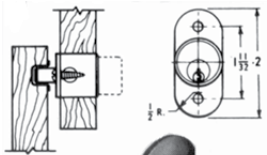

C8142  
C8143

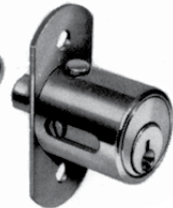

C8142

**Disc Tumbler**



C8042  
Locking Strike Type

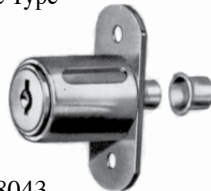

C8043

Key Blank:  
D4291

Order # 605-4291

7/8" Diameter

Key Blank:  
D8785

Order # 605-8785

Order #	Item #	Cyl Length	Tumbler	PRICE
605-0057	C8142 KA KA-101	1-1/8"	Pin	<b>\$52.90</b>
605-0058	C8142 KD	1-1/8"	Pin	<b>52.90</b>
605-0250	C8043 KA KA C415A	1"	Disc	<b>23.48</b>
605-0260	C8043 KD	1"	Disc	<b>23.48</b>
605-0005	C8042 KA KA C415A	7/8"	Disc	<b>44.04</b>

**PROGRAMMED MKGT, Inc.**



Sliding Door Lock, poly-bagged  
7/8" Length

**Hudson Lock**

Order #	Item #	Price
685-1001	1001 KA HL302	<b>\$18.26</b>
685-1011	1001 KD	<b>18.26</b>

**S. Parker Hardware**

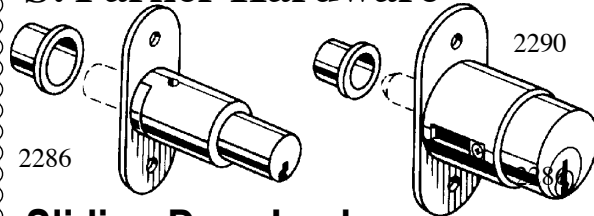

2286

2290

**Sliding Door Locks**

Mounting plates: 1-7/8" x 11/16". Bolt 9/32" dia. Individually boxed with cup strike and screws.

**#2290.** Solid brass, for 7/8" wood. Push bolt type. Pin tumbler. Uses M-1 key blank.

**#2286.** Polished Brass Push bolt for 7/8" wood.

Item #	Item #	Price
650-2290	2290PB31 KA US3	<b>\$15.16</b>
650-2286	2286PBA KA US3	<b>19.52</b>

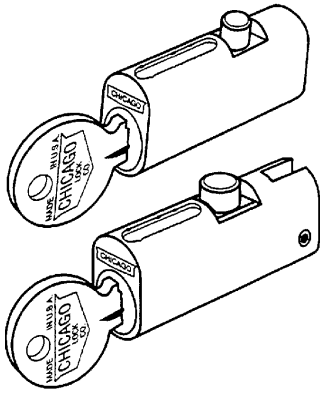

**COMPX: CHICAGO**

4-Pin Tumbler plug  
Die cast barrel with die cast bolt  
No. 5002LP has rectangular bolt  
Other models have round bolt  
Satin Chrome

Two keys furnished per lock.  
• Keyblank: DKP-1 (order #: 180-0001)

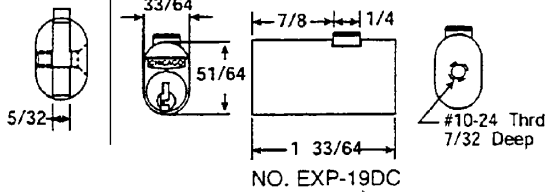
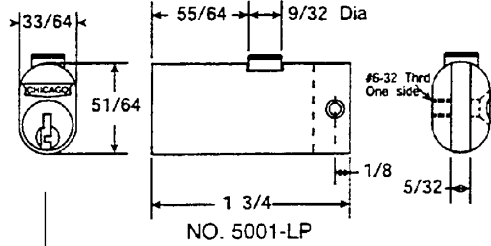
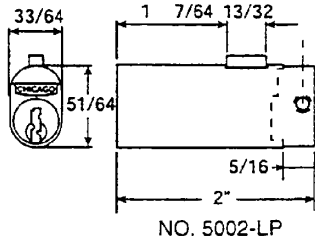

Item #	Keyed Alike	Keyed Different	L	Bolt	Price
5001-LP	180-5001 KA	180-5101 KD	1.75"	Round	<b>\$21.22</b>
5001-50L	180-5011 KA	180-5111 KD	1.75	Round	<b>25.46</b> Slot: 1/8" x 1/2"
5002-LP	180-5002 KA	180-5112 KD	2.00"	Square	<b>20.44</b>
EXP-19DC	180-5019 KA	180-5119 KD	1.50"	Round	<b>20.88</b>

**ILLINOIS LOCK**

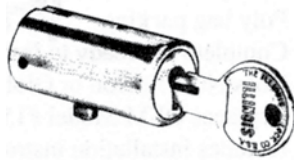

**Round Case**

Diameter: 13/16"  
Length: 1-37/64"

Order #	Item #	Catalog Price
395-7205	D7205 KA	<b>\$31.50</b>
395-7215	D7205 KD	<b>27.74</b>



**Signore File Lock**

Tool Removable plug using CompX standard key codes, round bolt.

Order #	Item #	Catalog Price
605-1030	M43017 KD	<b>\$31.18</b>
605-1035	M43017 KA	<b>31.18</b>

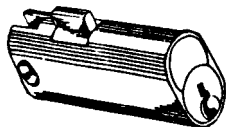

**NSP / ESP**

Same size as Chicago 5002-LP  
Uses H20 (Order # 685-0020) key blank

Order #	Keying	Cat.Price
845-5002	S 5002 KA	<b>\$13.90</b>
845-5012	S 5002 KD	<b>13.90</b>

**File Cabinet Locks**

Tool removable plug using CompX standard key codes, rectangular bolt.

Order #	Item #	Catalog Price
605-1050	M43003 KD	<b>\$27.28</b>
605-1055	M43003 KA	<b>27.2 8</b>



**Shaw Walker Type**

Spring type bolt has 1/8" travel.  
Keyed different, key removable in locked position only. Supplied with 2 keys. Uses D8776 (IN8) blank.

Order #	Item #	Price
605-8047	NAT C8047-26 KD	<b>\$54.10</b>



SRS SALES CO.

**File Cabinet Locks**

Keyblank: M1

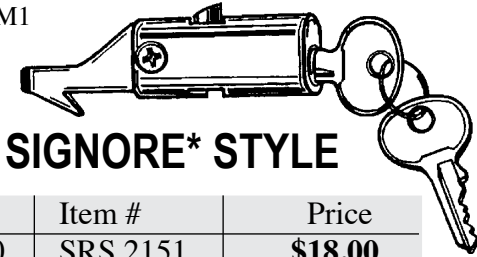

**SIGNORE\* STYLE**

Order #	Item #	Price
726-0050	SRS 2151	<b>\$18.00</b>

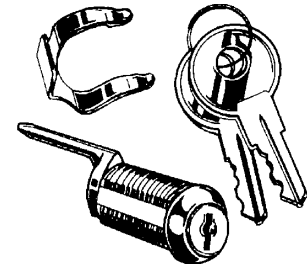

**GLOBAL\*  
LK26 STYLE**

Keyblank: IN8

Order #	Item #	Price
726-0060	SRS 2176	<b>\$15.50</b>

\* Not manufacturer original equipment products.

Keyblank: IN8

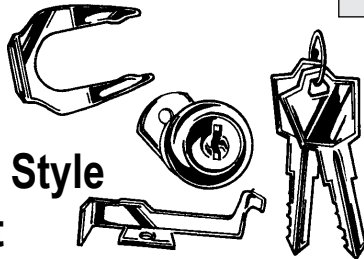

**For HON\* F28 Style  
Filing Cabinet**

Keyed different. Replaces original manufacturer's model.

726-0040	2185 Hon F28	<b>\$18.50</b>
----------	--------------	----------------

Poly bagged; Complete set, ready to install.

Key Changes: 10,  
(coded 1 thru 10). Keyed Different only.

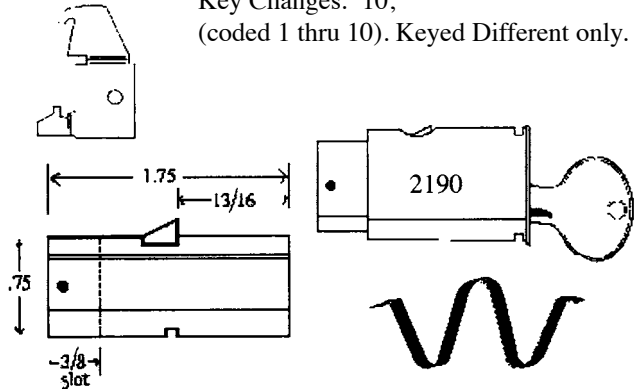

**Fits HON\* F26 File Cabinet**

The model 2190 Filing Cabinet Lock is a substitute for the HON-F26 model. Includes all mounting hardware, plastic sleeve, and clips. Uses M-1 key blank.

Order #	Item #	Price
726-0010	2190- KD	<b>\$28.34</b>

**Plastic Sleeve for #2190 (F26 kit)**

726-0011	SRS 2190E	<b>\$4.34</b>
----------	-----------	---------------

**SRS Lock Kit for Anderson Hickey  
Filing Cabinets (New Style)**

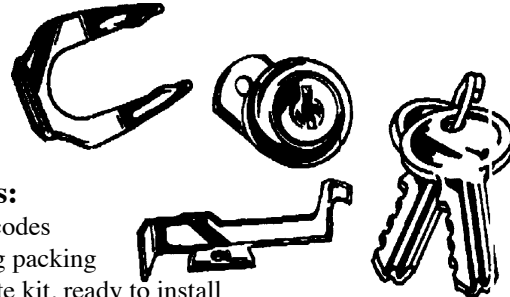

**Features:**

- 10 key codes
- Poly bag packing
- Complete kit, ready to install
- Does NOT fit Hon or Global
- Replaces OEM Model #15500
- Includes installation instruction sheet
- Fits new style vertical filing cabinets (Manufactured after 2-15-99) made by Anderson Hickey, Premier, and Globe.

Keyblank: IN8

Order #	Item #	Price
726-0080	SRS 2197	<b>\$18.50</b>

**SRS ANDERSON HICKEY\*  
#15400 STYLE**

Complete set, ready to install. Replaces original manufacturer's model. Packed in convenient poly bag. Ten (10) coded key changes. SRS model 2194-KD. M-1 key blank.

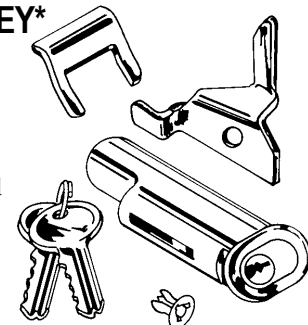

726-0030	SRS-2194-KD	<b>\$26.68</b>
----------	-------------	----------------

SRS SALES CO.

**File Cabinet Locks**

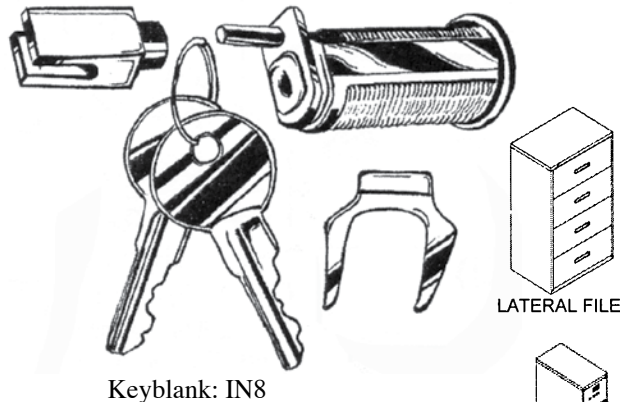

Keyblank: IN8

**SRS SALES**

**Lock Kit for HON® Lateral File Lock**

- Complete Kit, ready to install
- Fits Hon® **Lateral** Files with oval (Double D) cutouts  
(Does NOT fit files with round cutouts)

Order #	Item #	Catalog Price
726-0090	SRS-2188	<b>\$22.50</b>



**Secure Locking Bars**

Quickly installed on steel or wood cabinets. With all necessary hasps, staples and screws. Heavy Duty 1/2" x 1-1/2" channel steel.

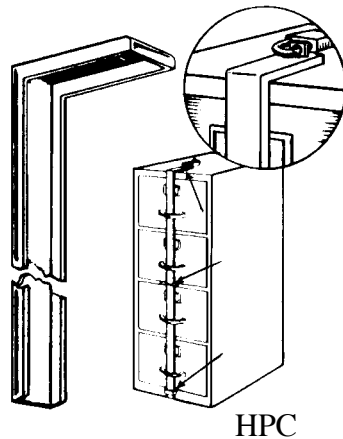

HPC

Order #	Item #	Drawers	Length	Price
360-0351	SLB-44	4	51-1/2"	<b>\$110.00</b>
360-0352	SLB-45	5	59-7/8"	<b>116.00</b>

**ABUS**

**Swing-Away File Bars**

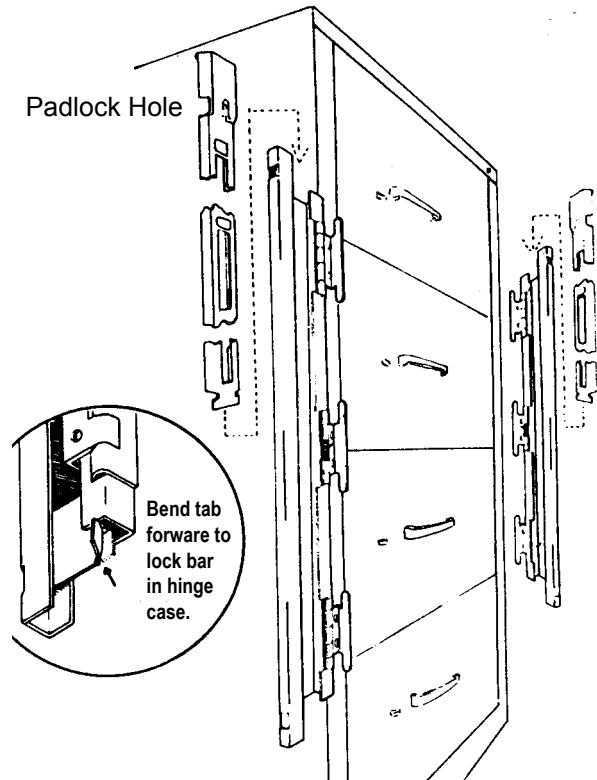

**Swing-Away File Bars**

Locks at every drawer. Multi-point locking design.

- Spring open action.
  - No storage problems.
  - Simple installation.
- Accepts #3 Master Padlock  
"D": # of Drawers.

Order #	Item #	D	Price
600-0001	<b>MKL-102</b>	1	<b>\$50.28</b>
600-0002	<b>MKL-202</b>	2	<b>\$48.14</b>
600-0003	<b>MKL-302</b>	3	<b>\$51.10</b>
600-0004	<b>MKL-402</b>	4	<b>\$52.30</b>
600-0005	<b>MKL-502</b>	5	<b>\$60.74</b>

**File Cabinet Locking Bars**

**Kaba Ilco  
File-Guard  
Locking Bars  
for  
File Cabinets**

Heavy channel steel bars and steel mounting bolts ensure maximum protection.

Standard and Self-Storing FILE-GUARD meet Department of Defense requirements for storage of secret and "Classified" material, when used with approved padlock.

FILE-GUARD with built-in lock. One piece construction. 5-Pin tumbler Schlage "C" keyway.

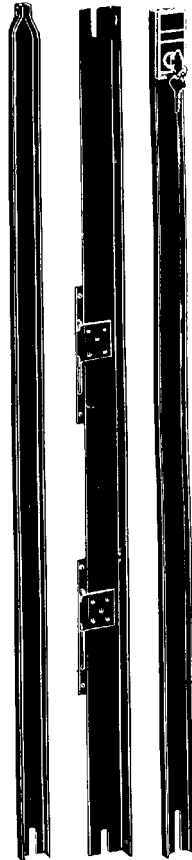

**Standard File-Guard**

Order #	Item	Drawers	Length	Cat. Price
265-0165	2502	2	29-1/2"	<b>\$85.40</b>
265-0166	2503	(U) 3	38"	<b>70.00</b>
265-0167	2504	4	52"	<b>92.40</b>
265-0168	2505	5	59-1/2"	<b>98.00</b>

**Self-Storing File-Guard**

265-0169	2572	2	29"	<b>\$100.80</b>
265-0170	2573	(U) 3	38"	<b>77.00</b>
265-0171	2574	4	51-3/4"	<b>112.00</b>
265-0172	2575	5	59"	<b>120.40</b>

**File-Guard With Built-In Lock**

265-0175	2584	4	52-1/2"	<b>\$119.60</b>
265-0176	2585	5	59-1/2"	<b>121.80</b>

**KABA ILCO  
File Guard Series**



File Guard is ideal for turning any ordinary filing cabinet into a security cabinet. Its steel channel bar and steel mounting bolts ensure maximum security for confidential, classified, and secret documents.

The push-button combination lock provides quick, easy, convenient day to day use, and frees you from the high cost of key control.

File Guard eliminates key control problems and makes an inexpensive one-time investment for long term security.

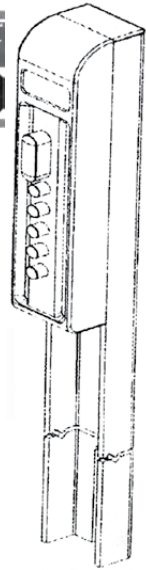

**FG 10 Series,  
Keyless Operation, Almond Finish**

Order #	Description	Length	Product #	Cat. Price
825-1022	2 Drawer	29"	FG12-B	<b>\$186.20</b>
825-1024	4 Drawer	51.25"	FG14-B	<b>194.60</b>



Padlock not included

**Major** File Cabinet Locking Bars  
Replaces McDowal-Craig

**MAJOR** File cabinet locking bar mounts on left hand side of cabinet. Will not block adjoining cabinets when in either locked or unlocked position. Red tape strip on inside of locking bar indicates unlocked position and protects painted finish on filing cabinet when locked.

49-1/2" Bar for 4 Drawer Cabinets, left hand mount.

Order #	Item #	Catalog Price
527-0300	FB-4L	<b>\$76.50</b>



## Cam Locks

12 per box

All prices are Catalog Prices

<b>NSP-C8300 \$6.18</b>	
<b>A: 3/8"</b>	<b>B: 1/4"</b>
845-8301	KA-340
845-8302	KA-341
845-8303	KA-342
845-8304	KA-343
845-8305	KA-344
845-8309	KD

<b>NSP-C8400 \$6.18</b>	
<b>A: 5/8"</b>	<b>B: 5/16"</b>
845-8401	KA-340
845-8402	KA-341
845-8403	KA-342
845-8404	KA-343
845-8405	KA-344
845-8409	KD

<b>NSP-C8500 \$6.18</b>	
<b>A: 7/8"</b>	<b>B: 21/32"</b>
845-8501	KA-340
845-8502	KA-341
845-8503	KA-342
845-8504	KA-343
845-8509	KA-344
845-8508	KD

Use Y11 (IN8, K54G) key blanks

## Metal Drawer Locks

Cat. Price: \$10.00 ea

### SOU-S-1974/5

845-1974	KD
845-1975	KA-340

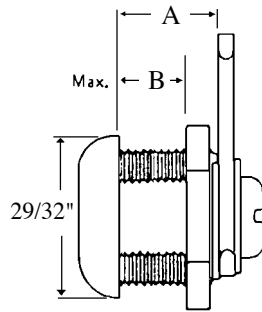
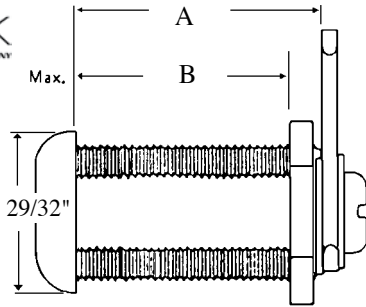
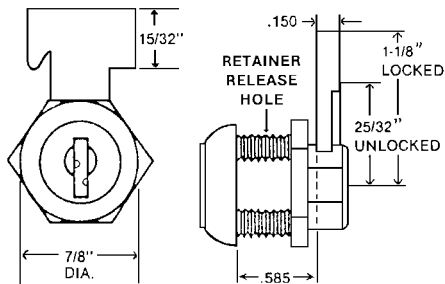

<b>NSP-C8600 \$6.18</b>	
<b>A: 1-1/8"</b>	<b>B: 15/16"</b>
845-8601	KA-340
845-8602	KA-341
845-8603	KA-342
845-8604	KA-343
845-8605	KA-344
845-8609	KD

<b>NSP-C8700 \$6.18</b>	
<b>A: 1-3/8"</b>	<b>B: 1-1/8"</b>
845-8701	KA-340
845-8702	KA-341
845-8703	KA-342
845-8704	KA-343
845-8705	KA-344
845-8706	KA-SL540
845-8709	KD



Quality and Value,  
the Security Professional's Choice

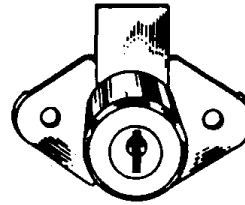

Catalog Price: \$6.18 ea

12 per box

## Drawer Locks

### S-711. 7/8" Brass

845-0717	KD
845-0712	KA-340
845-0713	KA-341
845-0714	KA-342
845-0785	KA-343
845-0716	KA-344

### SOU-S-711C.

#### 7/8" Cadmium

845-7110	KD
845-7111	KA-340
845-7112	KA-341

### SOU-S-712.

#### 1-1/8" Brass

845-7120	KD
845-7121	KA-340
845-7122	KA-341

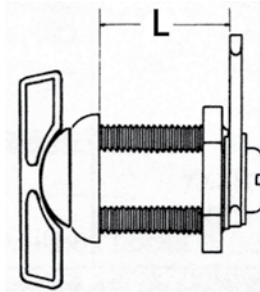

Includes all necessary parts to perform all locking functions:

## Thumbturn Locks

When you don't need a key!

Have threaded shells and come staked to a 90° rotation. Just apply the cam accordingly for any clockwise or counter-clockwise rotation. Spur washer included for wood installation.

- Hex Nut, • Sem Screw,
- 1-1/4" Straight Cam,
- 1-1/8" Offset Cam w/1/4" offset,
- Spur Washer, 1/8", • Cylinder Ring.



ESP

Order #	Item #	"L"	Catalog Price
845-8802	TT625STD	5/8"	<b>\$6.50</b>
845-8803	TT875STD	7/8"	<b>6.50</b>
845-8801	TT1125STD	1-1/8"	<b>6.50</b>



**Single Bitted Locks**

Drawer & door lock with removable bolt & plug. 3/4" diameter cylinder. Assembled or disassembled in just a few seconds.

- Satin Chrome.
- Five disc Tumbler.
- Removable plug feature
- Steel locking bolt
- Two keys furnished per lock.

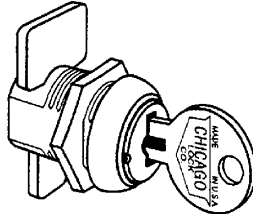

CHI-1974: \$12.06  
CHI-1975: \$12.52

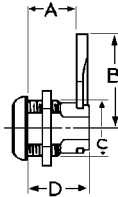

Order #	Item #	A	B	C
180-1974	1974 KA-1289	19/32"	25/32"	53/64"
180-1984	1974 KD	19/32"	25/32"	53/64"
180-1975	1975 KA-1454	21/32"	15/16"	57/64"
180-1985	1975 KD	21/32"	15/16"	57/64"

**Single Bitted Cam Locks**

Cylinder: 3/4" dia. 1-1/8" cam.  
1-1/2" cyl. length.  
\$15.80 Each

Order #	Item #
180-1704	1704-KA-1289

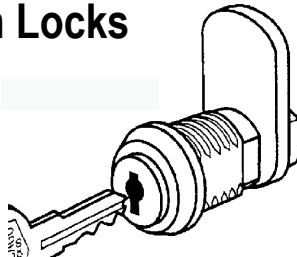

**Double Bitted Cam Locks**

3/4" diameter cylinder, 7/16" Cyl. length,  
key removed in locked position only.  
1-1/8" removable cam.  
\$21.22 Each.

K-4 key blank

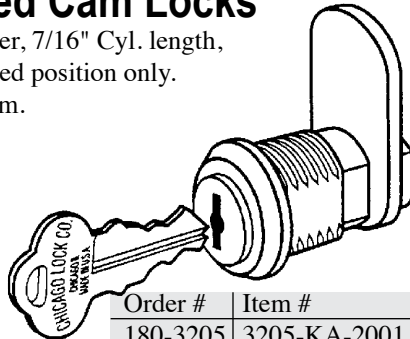

Order #	Item #
180-3205	3205-KA-2001
180-3215	3205-KD

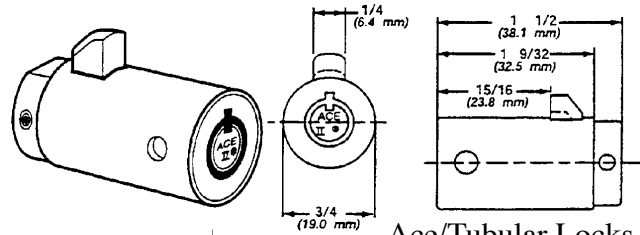

Ace/Tubular Locks

Set screw hole for anti-pull feature when used in "T" Handle with set screw feature.

Meets NAMA dimensional standards.

**Ace® Flush Handle Cylinders**

For standard ACE II cylinder.

Ace II Patented assembly.  
7 Pin tumbler.  
Brass locking bolt.  
Chrome finish.

180-4255	4255-19 KA	\$21.68
180-4355	4255-19 KD	21.68

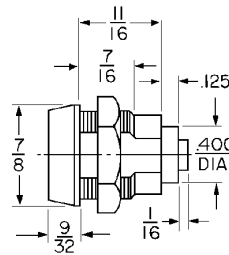

**Single Bitted Die Cast Lock**

With 3/4" dia. cylinder. Key removed in both locked or unlocked positions. Designed to be used in conjunction with your latching mechanism. Item # C17256 TNH.

180-1725	KA-1101	\$13.48
180-1735	KD	13.48

**Ace II™ 7-Pin Tumbler Screw Type Locks**

Patented Ace II® lock assembly in 3/4" diameter.

Barrel with two flats  
- 5/8" across.

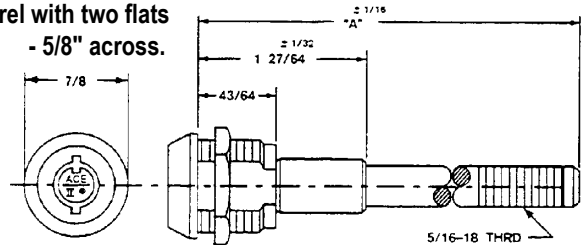

360° key rotation with keypull every 180°. Includes body nut and two keys.

For drawing covers down tight on coin meters. 7-1/32" length.

Order #	Item #	Catalog Price
180-4107	4107 KA#7341	\$31.00





KA furnished with 1 key, KD with two. 10 to a box.

**02066. US26D Chrome.** For 7/8" material:

200-0513	KA-CAT30	<b>\$9.64</b>
200-0514	KD	

For 1-1/8" material:

200-0517	KA-CAT30	<b>\$9.64</b>
----------	----------	---------------

**02066, US4 Brass Finish.**

200-0470	KA-CAT60	<b>\$8.32</b>
200-0472	KA-CAT30	
200-0474	KA-AUE1	
200-0512	KD	

For 1-1/8" material:

200-0515	KA-CAT30	<b>\$8.32</b>
200-0516	KD	

**Disc Tumbler 3/8" Throw**

For 7/8" material. Requires 7/8" diameter hole.  
Blank: 5860KS

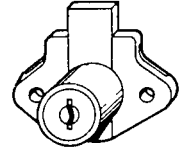

**Disc Tumbler.**

**02065 Dead Bolt.** US4. 3/16" bolt. For 7/8" thick material: **\$10.22**

200-0503	KA-CAT30
200-0504	KD

**02065-1/2 Latch Bolt.**

Disc Tumbler. US 4. 3/16" bolt. For 7/8" material: **\$12.30**

200-0507	KA-CAT30
200-0508	KD

**Pin Tumbler**

**0666.** Mortise mounting Dead Bolt. 5/16 bolt. For 7/8" material. **\$54.28**

200-0527	KA-4T37526
200-0528	KD

Latch Bolt. 0666-1/2 **\$61.62**

200-0529	KA4T37526
200-0530	KD

Blank: 5865JVR  
Order # 200-0109

Requires 7/8" diameter hole.

**Dead Bolt**

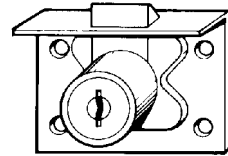
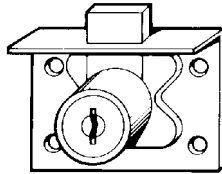

**Latch Bolt**

Blank: 8618C-R1  
Order # 200-0120

**DISC TUMBLER DRAWER LOCKS.**

Thickness of material For surface mounting: 7/8"; For Half-Mortise Mounting: 1-1/8"

**02068 Dead Bolt.** 3/16" bolt. US4. **\$10.58**

200-0519	(U) KA-CAT30
----------	--------------

(U) Available while supplies last

Blank: 5865JVR  
Order # 200-0109

Requires 7/8" diameter hole.

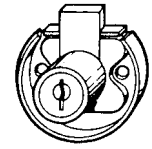

**Drawer Locks**

11/32" throw. US4. For 7/8" material:

200-0565	02067 KA	<b>\$8.32</b>
200-0566	02067 KD	<b>8.32</b>

For 1-1/8" material:

200-0567	02067 KA	<b>8.32</b>
----------	----------	-------------

**Disc Tumbler**

Blank: 5860KS

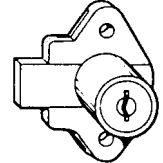

**Pin Tumbler,**

KA-4T37526

For 7/8" material thickness. 10/box.

200-0501	02063 KA	<b>\$33.58</b>
200-0502	02063 KD	<b>33.52</b>

Blank: 8618C-R1  
Order: 200-0120

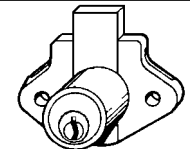

Blank: 5865JVR

**Handle Locks.**

**Disc Tumbler**

Furnished less cam. US26D Spindle: 25/32", 3-1/2".

**COR-1000 \$23.06**

200-0592	1000 KA
200-0593	1000 KD
200-0594	1001 KA
200-0595	1001 KD

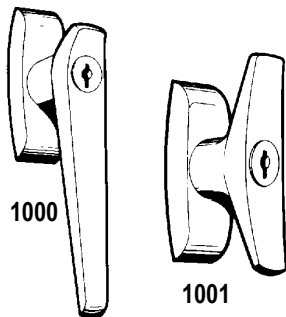

Blank: 5865JVR  
Order # 200-0109

**Panel Board Locks.**

Self latching latch bolt. US26D. 25 to a box. Disc Tumbler. **COR-15767**

Left hand: **\$14.00** each

200-0563	KA-CAT60
----------	----------

Right hand: **\$14.00** each

200-0561	KA-CAT60
----------	----------

Blank: 5860KS

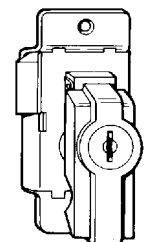

RH Shown

**SHOWCASE LOCKS**

**CABINET LOCKS**

**COMPX: FORT**

**Showcase Locks**

Uses Fort-S900  
Key blank Order #  
310-5901

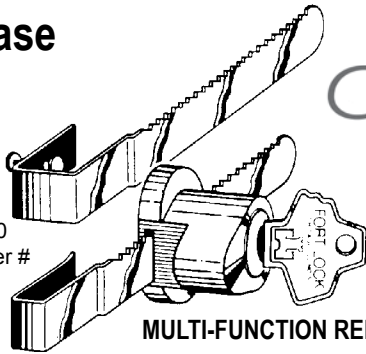

**CompX**  
**FORT**

Blank:  
Fort 775  
#310-0775

**MULTI-FUNCTION REKEYABLE**

**Fort MFWSG9000 Series.**

- \* Provided with two locking bars (one adjustable bar for wood, and one adjustable bar for glass).
- \* Exclusive floating wafer tumblers provides more resistance to picking.
- \* Promotes repeat business from key duplication.

Order #	Item #	Each
310-9000	MFWSG9000-KA	<b>\$30.40</b>
310-9010	MFWSG9000-KD	<b>30.40</b>



**FORT**

Ace/Tubular Locks

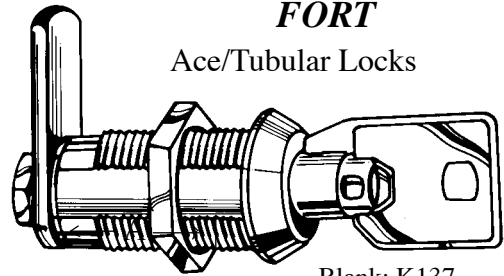

Blank: K137

**Cam Locks**

**High Security Tubular Lock**

7 Pin Tumbler,  
Circular Keyway.

Comes with two cams, 24 to a box.

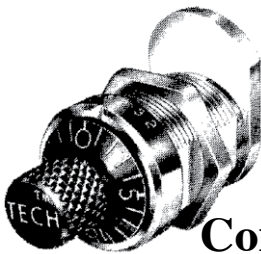

**CCL**

**Combination Cam Locks**

**Key Blank:  
None!**

Order #	Item #	Length	Price
869-0020	CK2113	5/8"	<b>\$14.84</b>
869-0030	CK3113	7/8"	<b>15.54</b>
869-0040	CK4113	1-1/8"	<b>15.77</b>

"A" Dimension Order #

<b>FOR-MFW1038</b>		
3/8"	310-2000 KD	
	310-2005 KA-27379	<b>\$21.76 each</b>
	310-2010 KA-27380	

<b>FOR-MFW-A-058</b>		
5/8"	310-2015 KD	
	310-2020 KA-27379	<b>\$21.76 each</b>
	310-2025 KA-27380	
	310-2030 KA-27381	

<b>FOR-MFW-A-078</b>		
7/8"	310-2035 KD	
	310-2040 KA-27379	<b>\$22.46 each</b>
	310-2045 KA-27380	

<b>FOR-MFW-A-118</b>		
1-1/8"	310-2050 KD	
	310-2055 KA-27379	<b>\$22.46 each</b>
	310-2060 KA-27380	

<b>FOR-MFW-A-148</b>		
1-1/2"	310-2065 KD	
	310-2070 KA-27379	<b>\$22.46 each</b>
	310-2075 KA-27380	

**Single Bitted Cam**

**Locks with Universal**

**Keyway. \$12.22 ea (catalog price)**

Replaces C8800

Stainless steel finish.

"A" dimension is 1-3/4"

Order #	Item #
310-2300	MFW23168 KA-217
310-2305	MFW23168 KA-221
310-2310	MFW23168 KD

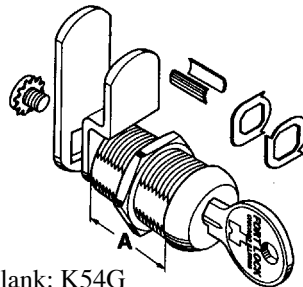

Blank: K54G



**FORT Multi-Function Metal Desk Drawer Locks**

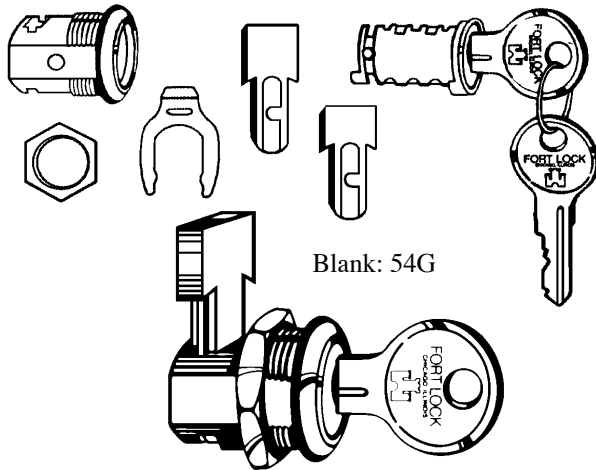

Adjustable Length, fits most metal desk drawers. Cylinder lock w/2 keys.  
 Reversible bolt provides two lock dimensions.  
 Clip and nut retainers.  
 Two sizes of lock bolts included. Easy to install.  
 Polished nickel finish

Order #	Item # - Keying	
310-3000	MFW3010-KA217	<b>\$11.92 ea</b>
310-3005	MFW3010-KA221	
310-3010	MFW3010-KD	

**Dust Covers:**



Fort Dust Covers Fits over the head of standard cam locks.

310-0001	DC1	Steel Cover	<b>\$12.10</b>
----------	-----	-------------	----------------

**Spur Washers**

... for cam locks.

Order #	Item #	Cat. Price
045-0117	AW1	<b>\$1.50 ea.</b>



**Wood Drawer Lock**

**Multi-function:**

Spring-latch or Deadbolt (shown) Function.

Key Blank: 54G

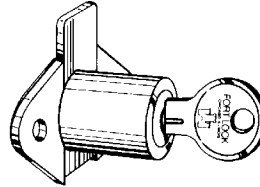

**Catalog Price: \$14.64 Each**

Order #	Item #	Keying	Finish	Material
845-3000	MFW23007	KA-217	32D	7/8"
845-3010	MFW23007	KD	32D	7/8"

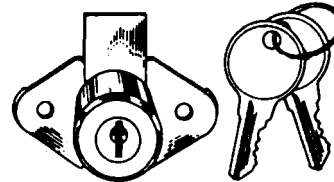

**ILCO**

6/box

**Drawer Locks**

Brass Finish

**1700 \$10.82**

1-1/8" 505-1702 KA



**Flange Lock Standard**

7/8" flange lock and plug with a 1-1/2" straight cam.

Order #	Item #	Cat Price
605-1040	P45262 KD	<b>\$35.08</b>
605-1045	P45262 KA	<b>35.08</b>

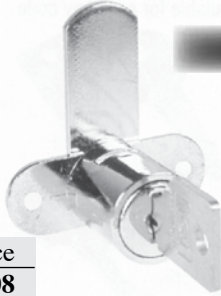

**Steelcase Add-On Lock**

Plug and cylinder using CompX standard "R" key codes.

Order #	Item #	Cat. Price
605-1000	R43786 KD	<b>\$27.28</b>
605-1005	R43786 KA	<b>27.28</b>



**SpaceCo Cam Lock**

Plug, cylinder and hook cam using CompX standard key codes.

Order #	Item #	Cat Price
605-1010	M45836 KD	<b>\$25.98</b>
605-1015	M45836 KA	<b>25.98</b>



**GF Cam Lock**

Plug, cylinder and hook cam using CompX standard key codes.

Order #	Item #	Cat Price
605-1020	P45242 KD	<b>\$32.48</b>
605-1025	P45242 KA	<b>32.48</b>



**HON Cam Lock**

Plug, lip grooved cylinder and 9/16" straight cam with hole using "ES" key codes.

Order #	Item #	Cat. Price
605-1060	M45883 KD	<b>\$17.18</b>
605-1065	M45883 KA	<b>17.18</b>



**Hirsch Cam Lock**

Plug, clip grooved cylinder and 5/8" pin cam using "ES" key codes.

Order #	Item #	Cat Price
605-1070	M45976 KD	<b>\$17.74</b>
605-1075	M45976 KA	<b>17.74</b>



**Cam Locks**

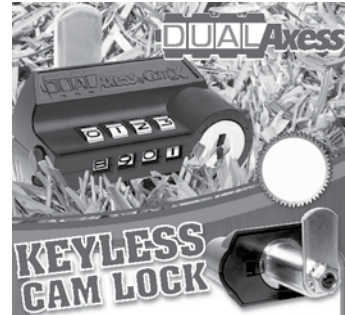

**KEYLESS CAM LOCK**

**DualAxess by CompX Security Products**

- innovative Combination Cam Locks with key override.

DualAxess can be retrofit for existing wood or metal applications to give keyless access and to eliminate keys. The lock can be mounted vertically or horizontally on flush, overlay or lipped/overlay applications.

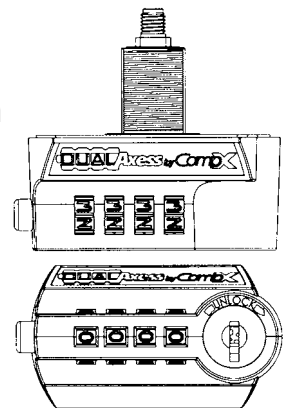

Attach the cam for 90° latching in any direction, based on individual application needs. To change the combination, the current combination and a valid key is needed.

Can be operated using either a combination or a key.

- 10,000 possible combinations
- Replace any standard cam lock
- Retrofits into existing 3/4" wood or metal holes
- Small profile fits most doors and drawers
- Removable lock plug for easy rekeying
- Master keying standard
- Heavy duty die cast construction
- 100% mechanical - no batteries needed

Order #	Item #	Length	Catalog Price
605-8030	D8030-19	7/8"	<b>\$46.40</b>
605-8031	D8031-19	1-3/8"	<b>46.40</b>

Electronic Cabinet Locks



**eLock**  
Be in Control with CompX eLock

A keyless, standalone electronic access control lock for cabinets - drug and supply cabinets, key control boxes, medical & personnel record cabinets - anywhere access control is needed or required.



**Features**

- 250 user/supervisor codes
- Audible alarm bolt system
- Motor driven latching mechanism
- Compatible with 12-volt electric door strikes
- Audit trail of last 1500 access attempts with date, time, and user name
- 4 AA battery pack mounts remotely; Alkaline batteries recommended - Not Included
- "Jump Start" 9-volt battery power port allows the user, with a valid credential, to access the CompX eLock when the batteries are exhausted
- Standard RJ11 communications port for audit trail download
- Surface mounted
- Low battery indicator

Order #	Item #/Type	Catalog Price
605-2000	EL-2004-MSKP Magstripe/Keypad	<b>\$601.20</b>
605-2005	EL-2004-PRKP Prox Reader/Keypad	<b>844.80</b>



**eLock Refrigerator Locks**

eLock refrigerator kit provides the same security and monitoring capabilities as the cabinet eLock.

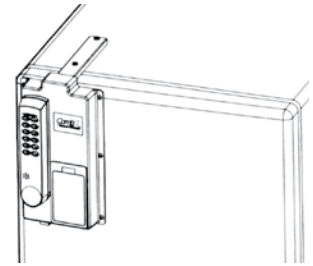

Kit comes with an eLock, a gear-driven spring bolt mechanical latch (factory installed), and a strike plate. The kit mounts externally and can be used with refrigerators and freezers in almost any application - pharmacies, nurses' stations, research labs - wherever cold storage access control is needed or required.

As with the cabinet eLock, the eLock refrigerator kit is a keyless system. Since latch is a spring bolt, simply close the door - no need for cumbersome hasps and padlocks.

Order #	Item #/Type	Catalog Price
605-2010	EL-KP-FRKIT Keypad	<b>\$613.20</b>
605-2015	EL-MSKP-FRKIT Magnetic Stripe/Keypad	<b>745.20</b>
605-2020	EL-PRKP-FRKIT Prox Reader/Keypad	<b>978.00</b>

**Electronic Access Control for Cabinetry**

CompX eLock is a highly engineered lock with a motor-driven latch. Its uncompromising



lock control electronics include a non-volatile memory that stores 250 user / supervisor codes and audit trail. With optional lockView audit trail software, CompX eLock remembers 1500 access attempts. Programming is simple with numeric keypad or Windows based LockView software.

**Numeric Keypad**

Provides authorization with a PIN code of variable length.

Order #	Item #	Catalog Price
605-2025	EL-2004-KP	<b>\$464.40</b>



**Pin Tumbler Door & Drawer Locks**

Uses D4291 Keyblank, Order # 605-4291.  
Key removable in both locked and unlocked positions.

**Spring bolt Door Lock**

Pin Tumbler Cylinder length: 3/4".

**\$53.46**

Order #	Item #
605-0053	C8139-26D KA 915
605-0054	C8139-26D KD

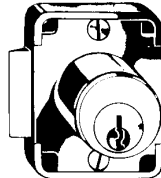

Blank: D4291

**7/8" Cylinder length**

**Deadbolt Door Lock. \$36.34**

Order #	Item #
605-0154	C8173-4 KA 915
605-0156	C8173-4 KD
605-0158	C8173-4G KA 915
605-0160	C8173-4G KD
605-0040	C8173-26D KA 915

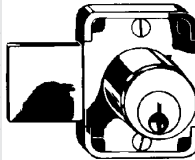

Blank: D4291

**1-1/8" Cylinder length**

**Deadbolt Door Lock. \$36.34**

Order #	Item #
605-0041	C8174-26D KA
605-0042	C8174-26D KD

DOOR LOCK

**7/8" Cylinder length Deadbolt**

**Drawer Lock. \$36.34 Each**

Order #	Item #
605-0162	C8178-4 KA915
605-0164	C8178-4 KD
605-0051	C8178-26D KA915

DRAWER LOCK

**1-1/8" Cylinder length**

**Deadbolt Drawer Lock. \$36.34**

Order #	Item #
605-0163	C8177-26D KA 107
605-0165	C8177-26D KD

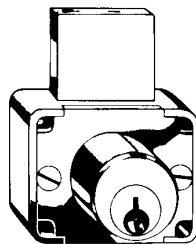

Blank: D4291

**1-3/8" Cylinder length**

**Deadbolt Drawer Lock. \$36.34**

Order #	Item #
605-0061	C8179-26D KA 101
605-0062	C8179-26D KD

**Pin Tumbler Door & Drawer Locks**

For drawers, Half mortise type requires mortise for housing and 7/8" diameter hole for cylinder. Key removable in locked and unlocked positions except C8131. D4291 keyblank. Supplied with two keys, strike and mounting screws.

**Spring Bolt \$53.56 Each**

Order #	Item #
605-0170	C8131-4 KA 915
605-0172	C8131-4 KD
605-0045	C8131-26D KA 915
605-0046	C8131-26D KD

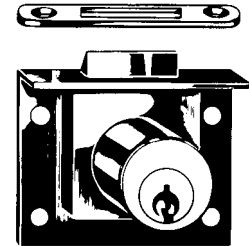

Blank: D4291

**Dead Bolt \$53.56 Each**

Order #	Item #
605-0174	C8133-4 KA 915
605-0176	C8133-4 KD
605-0047	C8133-26D KA 103
605-0048	C8133-26D KD



4 - Satin Brass  
26D - Dull Chrome

**Deadbolt \$53.46**

Cylinder Length: 1-1/8"

Order #	Item #
605-0049	C8135-26D KD
605-0050	C8135-26D KA 915

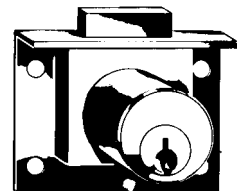

**Pin Tumbler Metal Drawer Locks**

For center drawers of metal desks. Fits special piercing of drawer front and seldedge. Key removable in both locked and unlocked positions. Uses D4291 keyblank. Supplied with two keys and mounting nut. 19/32" Cylinder Length. 7/16" Bolt Travel. 1/4" max material thickness. Bolt throw: 7/16"



Blank: D4291

Order #	Item #	Price
605-0182	C8137-26D KA 915	<b>\$31.76</b>
605-0184	C8137-26D KD	<b>31.76</b>



NATIONAL

**Disc Tumbler  
Door & Drawer Locks**

Surface mounted. Requires 7/8" diameter hole for cylinder. Key removable in both locked and unlocked positions. Supplied with two keys and mounting screws. C8706 supplied with strike.



C8704



C8703



C8706  
Spring  
Bolt

Blank: D8785  
Order # 605-8785

**Dead Bolt**

Disc Tumbler, Cylinder length: 15/16"

Order #	Item #	Finish	Keying	PRICE
605-0081	(U) C8703-3	Bright Brass	KA	<b>\$12.26</b>
605-0082	(U) C8703-3	Bright Brass	KD	<b>12.26</b>
605-0083	(U) C8703-4G	Antique Brass	KA	<b>12.26</b>
605-0084	(U) C8703-4G	Antique Brass	KD	<b>12.26</b>
605-0085	(U) C8703-14A	Bright Nickel	KA	<b>11.96</b>
605-0086	(U) C8703-14A	Bright Nickel	KD	<b>11.96</b>
605-0087	C8704-3	KA	C415A	<b>\$12.64</b>
605-0088	C8704-3	Bright Brass	KD	<b>12.64</b>
605-0186	C8704-4G	Antique Brass	KA	<b>12.64</b>
605-0188	C8704-4G	Antique Brass	KD	<b>12.64</b>
605-0190	C8704-14A	Bright Nickel	KA	<b>12.26</b>
605-0192	C8704-14A	Bright Nickel	KD	<b>12.26</b>

**Spring Bolt**

Blank: D8785

Order #	Item #	Finish	Keying	PRICE
605-0115	C8706 US3	Bright Brass	KA	<b>\$15.12</b>
605-0117	C8706 US3	Bright Brass	KD	<b>15.12</b>

**Disc Tumbler  
Drawer Locks**

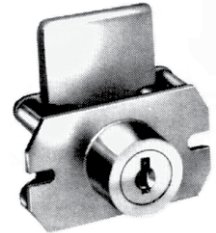
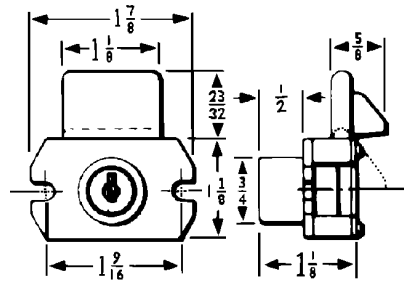

Blank: D8785

1/2" cylinder length.  
26D - Dull Chrome

605-0196	C8896-26D KD	<b>\$43.56</b>
----------	--------------	----------------

**Gang Locks**

Fort locking drawers in desk pedestals and other multiple drawer applications. Requires 7/8" diameter hole for cylinder and dado for bar, measuring 7/8" x 1/8" deep on inside of panel.

Key removable in locked and unlocked positions. Turning the key locks all drawers simultaneously (drawers must be in closed position) Bar moves studs into notch in drawer or slide, thus preventing drawer movement.

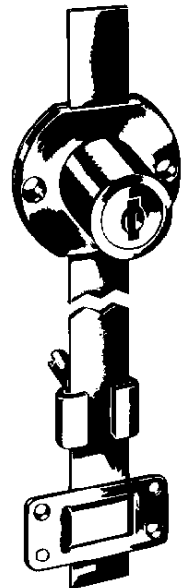

Blank: D8785

**D8090 \$34.26 Each**

Order #	Item #	Finish	Keying
605-0108	D8090-3	KA	C415A
605-0109	D8090-3	KD	
605-0110	D8090-4G	KA	C415A
605-0111	D8090-4G	KD	
605-0198	D8090-14A	KA	C415A
605-0200	D8090-14A	KD	

Uses D8785 keyblank.

**FURNITURE LOCKS**

**Chest Locks**

**C8412.** Lid lock for cedar chest application and other lid locking requirements. Surface mounted and requires a 9/16" diameter hold for cylinder. Key removable in locked or unlocked position. Pushbutton releases lid when lock is used as a latch to keep lid closed but not locked. One key supplied. 7/8" Cylinder length.

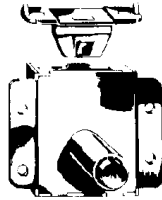

**D8194 Keyblank**

605-0075	NAL-C8414-KA-4G	\$25.66
----------	-----------------	---------

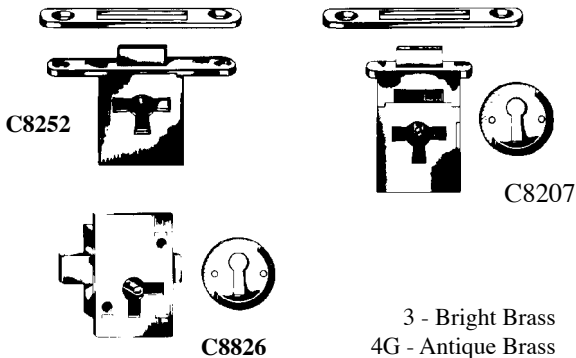

**Furniture Locks**

**C8207, C8252, C8826.** This group of locks is used primarily on furniture and other fine cabinetry. C8826 is surface mounted, other two require full 11/32" x depth of lock. One key supplied. Key removable in locked and unlocked positions. Dead bolt type. 25 per case.

**D8890 key blank.**

Order #	Part #	Installation	Price
605-0069	C8207-3	R.H. Door, Drawer Full Mortise	<b>\$17.22</b>
605-0070	C8252-3	R.H. Door, Drawer Full Mortise	<b>14.78</b>
605-0071	C8253-3	L.H. Door, Drawer Full Mortise	<b>14.78</b>
605-0107	C8826-3	Door/Drawer, Surface Mounted	<b>10.78</b>



**Handle Locks**

**For Metal Cabinet Doors.** R.H. or L.H. applications. Latch plate is used in 2 or 3 point latching (Below). Key removable in locked and unlocked positions:

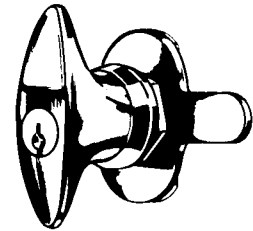

Blank: D4291

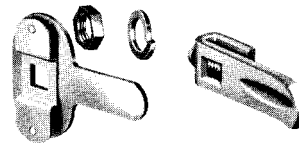

605-0065	<b>C8154-26D KA</b>	<b>\$78.32</b>
605-0066	<b>C8154-26D KD</b>	<b>\$78.32</b>

**3 Point Latch Plate:**

605-0098	<b>C8756</b>	<b>\$6.94</b>
----------	--------------	---------------

**Single Point Latch Tongue:**

605-0099	<b>C8757</b>	<b>\$5.42</b>
----------	--------------	---------------

**C8060 Cam Locks**

Operation - Dual function, stop washers provide for either 90° or 180° cam turn. Key removable in both locked and unlocked positions.

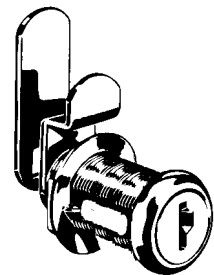

Cylinder length: 1-3/4".

Supplied with two keys (D8785), trim washer, spur washer for wood, mounting nut, two stop washers and two cams.

Order #	Item #	Finish	Catalog Price
605-0270	C8060 KA	3	<b>\$12.68</b>
605-0275	C8060 KD	3	<b>12.68</b>
605-0290	C8060 KA	14A	<b>12.22</b>
605-0295	C8060 KD	14A	<b>12.22</b>



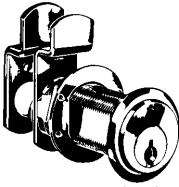

FLUSH mounting



Blank: D4291  
LIPPED Mounting

**Cam Locks PIN TUMBLER**

Brass Construction. \$27.84 ea  
Case Quantity: 10

C8102 1-1/16"	C8103 1-3/16"	C8106 1-7/16"	C8108 1-3/4"	C8109 1-3/4"
Flush	Lipped	Flush	Flush	Lipped
Finish 4 (Satin Brass):				
605-0129 KA	605-0132 KA	605-0136 KA	605-0140 KA	605-0142 KA
605-0130 KD	605-0134 KD	605-0138 KD	605-0141 KD	605-0144 KD
Finish 26D (Dull Chrome):				
605-0025 KA	605-0027 KA	605-0029 KA	605-0031 KA	605-0146 KA
605-0026 KD	605-0028 KD	605-0030 KD	605-0032 KD	605-0148 KD

<b>C8051 7/16"</b>
<b>\$8.68</b>
14A-Bright Nickel
605-0007 KA
605-0008 KD

<b>C8052 5/8"</b>
<b>\$8.68</b>
14A-Bright Nickel
605-0009 KA
605-0010 KD

<b>C8073 1-3/16"</b>
<b>\$8.68</b>
14A-Bright Nickel
605-0015 KA
605-0016 KD

**DISC TUMBLER**

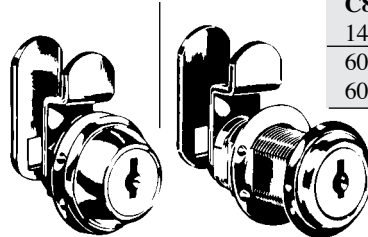

Blank: D8785

<b>C8054 15/16"</b>
<b>\$8.68</b>
14A-
605-0017 KA
605-0018 KD

<b>C8055 1-7/16"</b>
<b>\$8.68</b>
14A-
605-0019 KA
605-0020 KD
3- <b>\$9.20</b>
605-0150 KA
605-0152 KD

**Cam Locks**

Die Cast Construction  
• Case Quantity 25  
• Key Blank: D8785  
• Lipped or Flush

<b>C8073</b>	3-Bright Brass
	605-0011 KA
	605-0012 KD
	4G-Antique Brass
<b>\$9.20</b>	605-0013 KA
	605-0014 KD



**Cooler Locking Handles**  
Mounts on edge of freezer doors. Reversible.

605-0106	(U) C8765-26	<b>\$266.60</b>
----------	--------------	-----------------

C8762 and C8763 plugs are for earlier models of C8765 locking handles (59-1105) C8764 fits current C8765 Refrigerators & Cooler Handles (screw mounted). All use D8780 key blank. Disk tumbler.

605-0104	C8762	<b>\$17.08</b>
605-8764	C8764	<b>17.05</b>

**C8762**

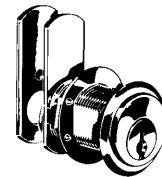

Price: \$27.84 Each

**Brass Pin Tumbler Cam Lock**

Replaces the C8111 :

Order #	Item #	Cyl
605-0220	C8101-26D KD	15/16"
605-0225	C8101-26D KA	15/16"

**HANDLE LOCKS**

Finish: 26D-Dull Chrome • Key Blank: D8785 • Case Quantity: 10

**C8747**  
**\$34.28**  
1" Spindle,  
5/16" sq.  
w/ 8-32 tapped  
end hole.  
605-0089 KA  
605-0090 KD

**C8749**  
**\$34.28**  
4" Spindle,  
5/16" sq.  
605-0091 KA  
605-0092 KD

**C8754**  
**\$34.28**  
3" Threaded  
Spindle.  
605-0095 KA  
605-0096 KD

**C8759**  
**\$34.28**  
3" Threaded  
Spindle.  
605-0102 KA  
605-0103 KD

**C8755**  
**\$29.72**  
3" Threaded  
Spindle.  
Non locking  
handle.  
605-0097

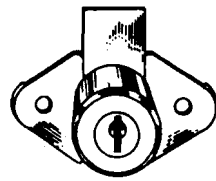

Blank: D8785

**C8803 Drawer Locks**

Surface mounted, requires 7/8" dia. hole for cylinder.

**Operation** - Key removable in both locked and unlocked positions.

Cylinder length: 15/16". With two keys (D8785) and mounting screw.

**Finishes**  
**3- Bright Brass**  
**4G - Antique Brass**  
**14A- Bright Nickel**

**\$11.46 ea.**

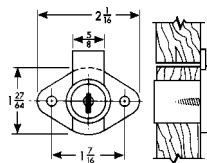

Order #	Finish	Keying
605-0300	3	KA
605-0305	3	KD
605-0310	4G	KA
605-0315	4G	KD
605-0320	14A	KA
605-0325	14A	KD

**Drawer Locks.**

Surface mounted. Requires 7/8" hole for cylinder. Cylinder removable from front of lock while lock remains in place. Key removed in both locked or unlocked position.

**\$29.60 ea**

605-8163	<b>C8163-4 KD</b>
605-8164	<b>C8163-4 KA</b>

Key Blank: D4291

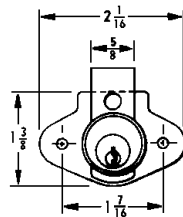

**Replacement Lock Housings & Cylinder**

For drawers 7/8" thick. Half mortise design. Interchangeable cylinders attached or removed through use of special key. Key removed in both locked & unlocked positions. Cylinder supplied with two keys. Lock housing supplied with cylinder removal key & mounting screws.

C8160

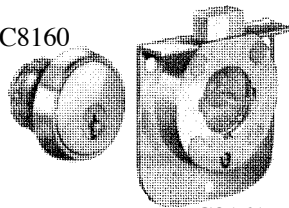

C8161

Blank: D4292

Order #	Item #	Price
605-8160	<b>C8160 KD Cylinder</b>	<b>\$51.30</b>
605-8161	<b>C8161 Housing</b>	<b>\$25.54</b>

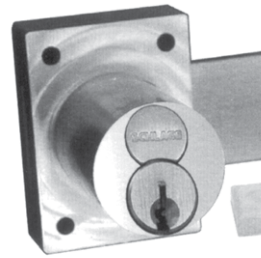

**Core Not Included**



#10-054  
1/4" plastic bar strike



#777-PA  
plastic actuator



#10-055  
1/2" plastic bar strike

**More Olympus on next page...**

#10-350  
plastic spacers

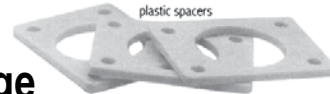

**Schlage Large Format IC Door Lock**

Accepts Schlage-style large format interchangeable cores (Schlage Quad, Numbered Section, Everest, and Schlage Classic IC cores.)

- For material thickness: 7/8" to 1-7/16"
- Barrel diameter: 1-1/8"

**Includes:** Three - #10-350 plastic spacers

#10-054 1/4" plastic bar strike

#10-055 1/2" plastic bar strike

#777-PA plastic acuator

Order #	Item #	Price
638-0110	OLY 777IC	<b>\$85.80</b>

**S. PARKER**

**S. PARKER HARDWARE HANDLE LOCKS**

Keyed differently. Rigid Handle. Chrome plated for right or left handed doors. 4" shaft. 1-3/4" plate.

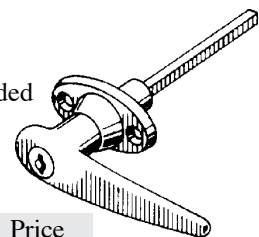

**"L" Handles:**

Order #	Item #	Price
217-5100	5100/9201/05365	<b>\$16.12</b>

**"T" Handle**

1-1/2" Plate. Rigid Handle

Order #	Item #	Price
217-6000	6000/TA-960	<b>\$10.60</b>

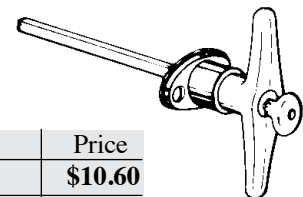



**Truly Rekeyable . . .**

**Commercial Cabinet Locks**

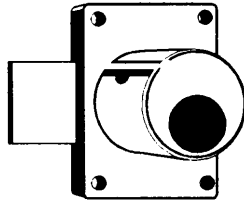

**Uses Medeco Cylinders**

**Lock Body Less Cylinder**

Uses Medeco replacement "Schlage" style lazy cam cylinder.

For use with the following Medeco Cylinders:

**5 pin:** #20-0801, #20-080002;

**6 pin:** #20-901, #20-090002

For key removable locked position only: 6 pin- #20-0100

**Includes:** 2 Cams Standard Barrel: 1-3/8"

Order #	Item #	Price
638-0100	OLY-700LC/MED US3	<b>\$58.08</b>

**I.C. Core Cabinet - Door/Drawer Locks**

Interchangeable Core for 6 & 7

Pin Arrow, Best, Eagle, & Falcon I.C. Core Cylinders.

Field reversible to fit both cabinet & drawer applications.

**Includes:** 3 Slotted Strikes, 6 Fixing Screws, 1 Extra "N" Pin. Standard Barrel: 1-1/4".

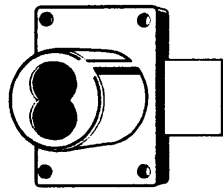

Order #	Item #	Cat. Price
638-0090	OLY-721 I.C. US3	<b>\$59.40</b>

**Schlage Style Commercial Cabinet Lock**

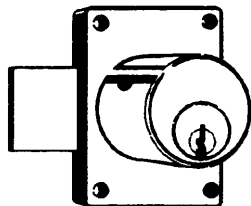

- \* .115 diameter pins (pinned 5)
- \* Two brass keys.
- \* Two slotted strikes
- \* Cylinder diameter: 1-1/8"
- \* Reversible, non-handed bolt

**\$67.58 each**

1-1/8" Material Thickness:

638-0050	700SC-US3 KA	Rekeyable, 6-Pin "C"; Ac-
638-0060	700SC-US3 KD	cepts original Schlage or Ilco
638-0070	700SC-26D KA	replacement deadbolt cylinders.
638-0080	700SC-26D KD	Compares to Schlage #46-002.
		6-pin, solid brass cynder

**Easy to Re-Key**

**Rekeying Instructions**



Insert key in plug to retain pins. Remove set screw and plug will slide out. Use following tool (HPC-SUT-0 .395 size) to remove cylinder core.

**OLYMPUS PIN TUMBLER DRAWER LOCK**

National D4291 Keyway.  
Compares to National C8163 Drawer Lock

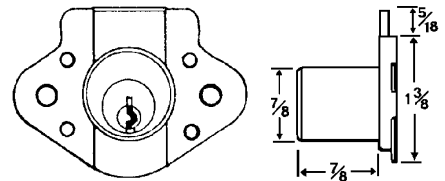

ORDER #	• 4 Pin tumbler • Rekeyable	
200-0782	N078-26D KD	<b>\$28.78</b>
200-0785	N078-US3 KA-915	<b>28.78</b>

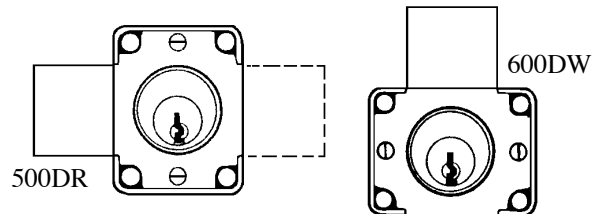

**500 & 600 Series Locks: Solid Brass Cylinder**

Pressure Cast Case; Brass Pins .095; Steel Backplate; Brass Bolt; Brass Keys (2 per lock); Rekeyable to 5-Pin system.

**5-Pin Tumbler, CCL-R1 Keyway.**

**Door Lock (For 7/8" Material)**

ORDER #	ITEM	Price
200-1003	500DR-US4 KD	<b>\$44.36</b>
200-1004	500DR-US4 KA-4T21579	<b>44.36</b>
200-1026	500DR-26D KD	<b>44.36</b>
200-1027	500DR-26D KA-4T21579	<b>44.36</b>

**For 1-3/8" Material:**

200-0553	500DR US4 KA	<b>44.36</b>
----------	--------------	--------------

**Drawer Lock (For 7/8" Material)**

200-2003	600DW-US4 KD	<b>\$44.36</b>
200-2004	600DW-US4 KA-4T21579	<b>44.36</b>
200-2026	600DW-26D KD	<b>44.36</b>
200-2027	600DW-26D KA-4T21579	<b>44.36</b>

**For 1-3/8" Material: (Olympus Lock)**

200-0535	0738/600DW US4 KA	<b>\$44.36</b>
200-0536	0738/600DW US4 KD	<b>44.36</b>



**Large Pin Schlage C Keyway Cabinet Locks**

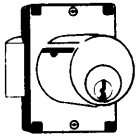

**L78R**  
(right-hand)  
DOOR LATCH  
LOCK

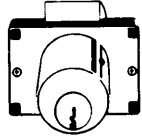

**L78V**  
(vertical-hand)  
DRAWER  
LATCH LOCK

RH= Right Hand  
VH= Vertical Hand  
LCA: Less Cylinder

**Door & Drawer Latch Locks**

Reversible, 1-1/8" barrel, 5-Pin Pin Tumbler

Order #	Item #	Hand	Catalog Price
638-0115	L78R 26D KD	RH	<b>\$85.54</b>
638-0120	L78R 26D KA101	RH	<b>85.54</b>
638-0125	L78V 26D KD	VH	<b>85.54</b>
638-0130	L78V 26D KA101	VH	<b>85.54</b>

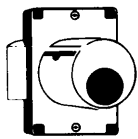

**L78R**  
(right-hand)  
DOOR LATCH  
LOCK  
LCA



**L78V**  
(vertical-hand)  
DRAWER  
LATCH LOCK  
LCA

**Door & Drawer Latch Locks,**

Less Cylinder, 1-1/8" Barrel

Order #	Item #	Hand	Catalog Price
638-0135	L78R-LCA 26D	RH	<b>\$74.32</b>
638-0140	L78V-LCA 26D	VH	<b>74.32</b>

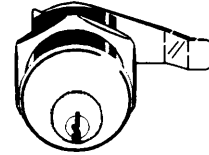

**820S**  
CAM  
LOCK

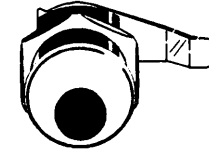

**820LC**  
CAM  
LOCK

**Large Pin Schlage C Keyway Cabinet Locks**

1-1/8" Cam Lock, 5-Pin

Order #	Item #	Catalog Price
638-0145	820S 26D KD	<b>\$69.04</b>

Less Cylinder:

Order #	Item #	Catalog Price
638-0150	820LC 26D	<b>\$70.35</b>

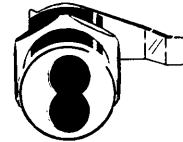

**920**  
CAM  
LOCK

**Cam Locks for Schlage LFIC Cores**

1-1/8", Less Cylinder

Order #	Item #	Catalog Price
638-0155	920LM/DM 26D	<b>\$57.94</b>



**729R**

**Sliding Door Ratchet Locks**

for Small Format IC Cores

For 1/4" Panels, Less Cylinder

Order #	Item #	Catalog Price
638-0160	729R 26D	<b>\$69.96</b>



## Locks for Wood Furniture & Cabinets

- Wide selection of locks to fit most furniture and cabinet applications.
- Available in several high quality finishes
- Removable lock plugs for complete keying versatility
- Pre-packaged in poly-bags

## Any Lock Plug Snaps Into Any Cylinder Body

All Timberline Locks consist of two separate components: a Lock Plug, and a Cylinder Body.

NOTE: Change Tool #D500KY is required to remove lock plugs from the cylinder bodies.

Most are designed for mounting in 3/4" panels. All mount easily with common #6 screws. Most are used in a 16.5 mm hole. Optional bezels are available that allow use of lock in hole from 3/4" to 7/8" in diameter.



## Lock Plugs for All Lock Types. \$8.62 ea

### Features:

- Small Diameter
- High Quality/Long Life
- Solid Brass Keys
- Coded of Face & Keys
- Master-Keyed Standard
- Removable Lock Plug

Order #	Item #	Keying	Finish
872-0005	C100LP-14A	KD	Polished Nickel
872-0010	C100LP-14A	KA-100T	Polished Nickel
872-0011	C100LP-14A	KA-101T	Polished Nickel
872-0015	C200LP-8	KD	Old English
872-0020	C200LP-8	KA-100T	Old English
872-0021	C200LP-8	KA-101T	Old English
872-0025	C300LP-19	KD	Black
872-0030	C300LP-19	KA-100T	Black
872-0031	C300LP-19	KA-101T	Black
872-0035	C400LP-20	KD	Stat. Bronze
872-0040	C400LP-20	KA-100T	Stat. Bronze
872-0041	C400LP-20	KA-101T	Stat. Bronze
872-0045	C500LP-3	KD	Polished Brass
872-0050	C500LP-3	KA-100T	Polished Brass
872-0051	C500LP-3	KA-101T	Polished Brass

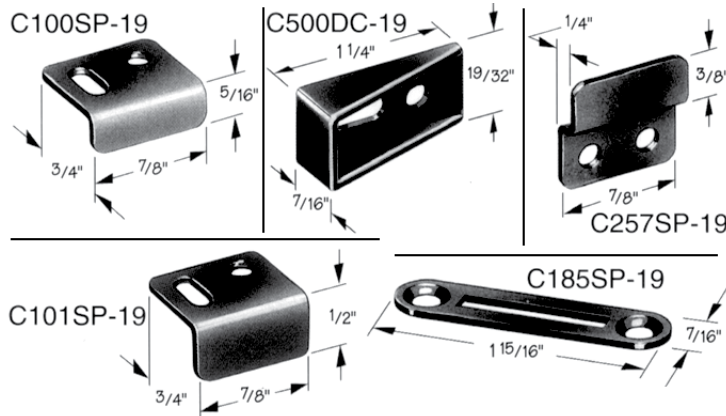

### Accessories

Order #	Item #	Price
872-0060	C100SP-19	1.90
872-0065	C101SP-19	1.90
872-0070	C185SP-19	1.90
872-0075	C257SP-19	1.90
872-0080	C500DC-19	.44

### Change Tool

Required to install & remove lock plugs in cylinder bodies.



Order #	Item #	Price
872-0500	D500KY	\$10.12

### Bezels

Allows cylinder bodies to be used with 3/4" through 7/8" diameter holes and permits use of locks in 7/8" panels.



Order #	Item #	Finish
872-0082	C100BZ-14A	Nickel
872-0083	C200BZ-8	Old English
872-0084	C300BZ-19	Black
872-0085	C400BZ-20	Statuary Bronze
872-0086	C500BZ-3	Brass



### Key Blank

Order #	Item #	Price
872-0300	D300KY	\$1.54 ea.

### Drill Bit. 16.5mm

872-1605	C165DB	\$123.26
----------	--------	----------



**Thick Panel Locks. C170CB**

**Application.** Universal type lock for either doors or drawers that can accommodate panel thickness from 7/8" to 1-3/8" thick.

**Operation.** 90° cam rotation, CCW to lock.

**Keying.** Order lock plug separately.

**Packaging.** Housing supplied with straight cam and bent cam. Housings are unplated. Cams are zinc plated.

Order #	Item #	Price
872-0170	C170CB	<b>\$9.88</b>

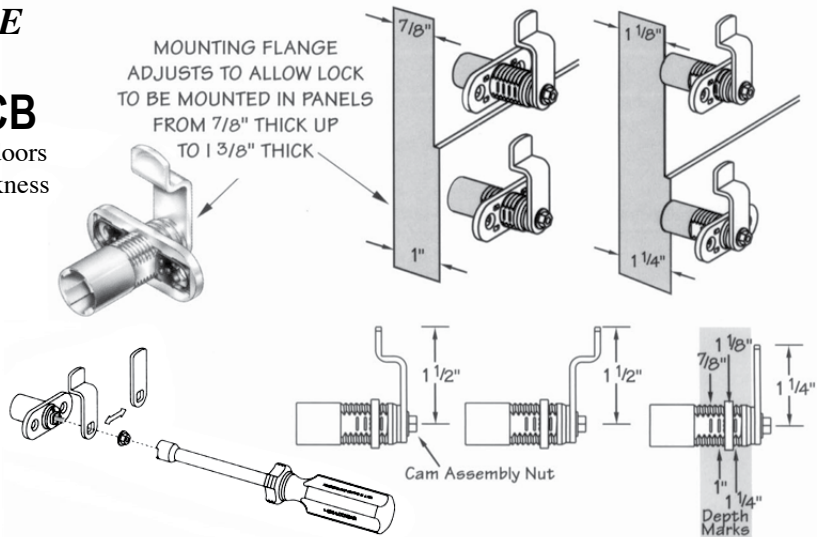

**Door Lock. C290CB**

**Application.** Surface mounted lock for locking doors. Setback of 9/32" is ideal for overlay doors.

**Operation.** 180° key rotation, CCW to lock, key removable in both lock and unlocked positions.

**Keying.** Order lock plug separately.

**Packaging.** Housing is black, toughened nylon. Cylinder is unplated. Cams are zinc plated.

Order #	Item #	Price
872-0290	C290CB	<b>\$7.78</b>

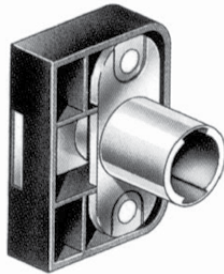

**Door Lock. C240CB**

**Application.** Low profile, surface mounted lock for locking doors. Setback of 3/32" is ideal for inset doors or locking one door behind another.

**Operation.** 180° key rotation, CCW to lock, key removable in both lock and unlocked positions.

**Keying.** Order lock plug separately.

**Packaging.** Housing is black, toughened nylon. Cylinder is unplated. Cams are zinc plated.

Order #	Item #	Price
872-0240	C240CB	<b>\$7.78</b>

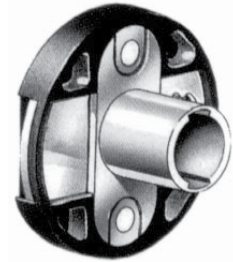

**Drawer Locks. C280CB**

**Application.** Surface mounted lock for locking drawers. Setback of 9/32" is ideal for overlay drawers.

**Operation.** 180° key rotation, CCW to lock, key removable in both lock and unlocked positions.

**Keying.** Order lock plug separately.

**Packaging.** Housing is black, toughened nylon. Cylinder is unplated. Cams are zinc plated.

Order #	Item #	Price
872-0280	C280CB	<b>\$7.78</b>

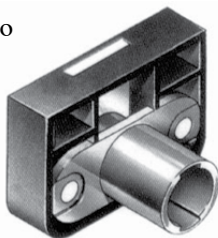

**Drawer Lock. C230CB**

**Application.** Low profile, surface mounted lock for locking drawers. Setback of 3/32" is ideal for inset drawers.

**Operation.** 180° key rotation, CCW to lock, key removable in both lock and unlocked positions.

**Keying.** Order lock plug separately.

**Packaging.** Housing is black, toughened nylon. Cylinder is unplated. Cams are zinc plated.

Order #	Item #	Price
872-0230	C230CB	<b>\$7.78</b>



## Front Gang Locks. D100CB

**Application.** For locking banks of drawers in desks, credenzas and other multiple drawer applications. Lock mounts on front of cabinet.

**Operation.** 180° key rotation, CCW to lock, key removable in both lock and unlocked positions.

**Packaging.** Cylinder is unplated.

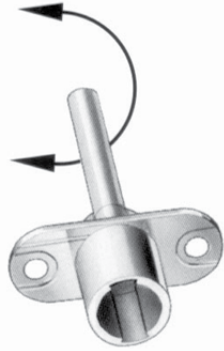

Order #	Item #	Price
872-0100	D100CB	\$7.78

**Keying.** Order lock plug separately.

## Side Gang Lock. D150CB

**Application.** For locking banks of drawers in desks, credenzas and other multiple drawer applications. Lock mounts on side of cabinet.

**Operation.** 180° key rotation, CCW to lock, key removable in both lock and unlocked positions.

**Packaging.** Cylinder is unplated.

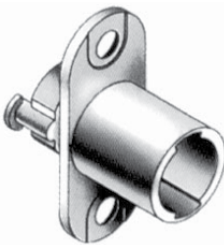

Order #	Item #	Price
872-0150	D150CB	\$7.78

**Keying.** Order lock plug separately.



## Push Locks. C175CB

**Application.** For locking sliding, bypass type doors. Requires 3/4" hole in front door for cylinder.

**Operation.** Pushing in cylinder locks doors, with or without key. 45° key rotation allows cylinder to pop back out to unlock doors. Key removable in both locked and unlocked positions.

**Keying.** Order lock plug separately.

**Packaging.** Supplied with nickel plated finish cup. Housing is black, toughened nylon.

Order #	Item #	Price
872-0175	C175CB	\$15.20

## Two Drawer Side Gang Lock. D270CB

**Application.** Two drawer gang lock for locking two pedestal drawers with a single lock. Mounts on side of cabinet.

**Operation.** 180° key rotation, CCW to lock, key removable in both lock and unlocked positions.

**Packaging.** Housing supplied with two C500DC-19 Drawer Clips. Housing is black, toughened nylon. Cylinder is unplated. Cams are zinc plated.

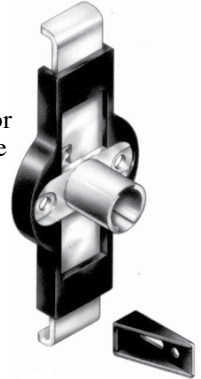

Order #	Item #	Price
872-0270	D270CB	\$8.72

**Keying.** Order lock plug separately.

## Cam Locks. C165CB

**Application.** Universal type lock for either doors or drawers. Kit contains a variety of easily switched cams to accommodate most locking situations.

**Operation.** 90° key rotation, CCW to lock.

**Packaging.** Cylinder supplied with two straight cams and two bent cams. Cylinder is unplated. Cams are zinc plated.



Order #	Item #	Price
872-0165	D165CB	\$9.98

**Keying.** Order lock plug separately.

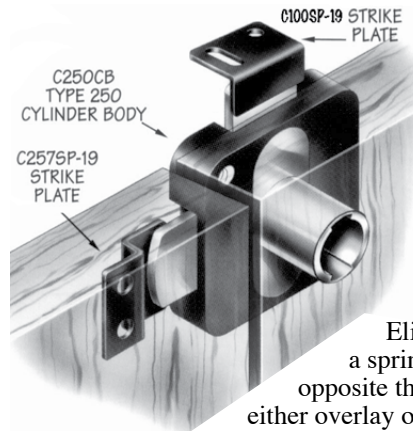

## Double Door Lock. C250CB

**Application.** Surface mounted lock for locking two adjacent doors. Eliminates the need for a spring catch on the door opposite the lock. Works with either overlay or inset doors.

**Operation.** 180° cam rotation, CCW to lock, key removable in both locked and unlocked positions.

**Packaging.** Supplied with two strikes as shown. Housing is black, toughened nylon. Cylinder is unplated. Cams are zinc plated.

Order #	Item #	Price
872-0250	C250CB	\$14.56

**Keying.** Order lock plug separately.

**KABA ILCO**

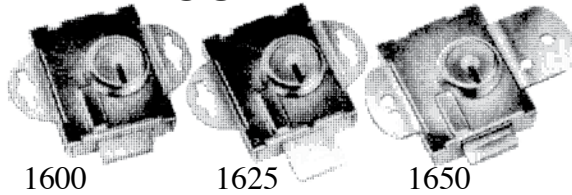

Letter Box Locks, Small Cabinets & Drawers  
The Lori flat tumbler locks feature three solid brass tumblers. Interchangeable with the Eagle 2616-1/4 C.

505-1600	LOR-1600	<b>\$8.64</b>
505-1625	LOR-1625	<b>9.52</b>
505-1650	LOR-1650	<b>9.52</b>

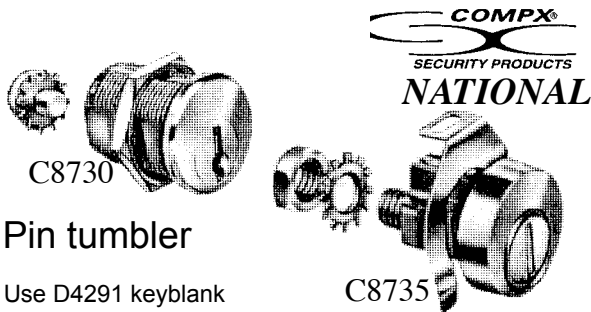

**Pin tumbler**

Use D4291 keyblank

**"Multi-cam" Mailbox Locks**

5 Cam Configurations; 14A Finish (Bright Nickel). Key removable in locked position only. Keyed-different only.

**For Inside Mailboxes: C8730**

For interior architectural mail boxes. Nut mounted. American • Auth • Florence • Miami- Carey • Bommer

605-8730	C8730	<b>\$11.78</b>
----------	-------	----------------

**For Outside Mailboxes: C8735.** For exterior-mounted neighborhood boxes. Has keyway dust shutter for lock protection. Clip mounted. Auth • Bommer • Cutler • Federal • Florence • Superior.

605-8735	C8735	<b>\$14.94</b>
----------	-------	----------------

**TACO Mailbox Locks.**

For Trine and Keil.

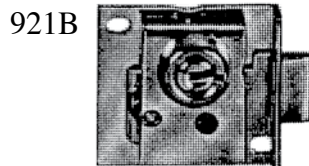

350-0921	921B TA955	<b>\$2.36</b>
----------	------------	---------------

COMPX: National



**Postal Locks**

The only mailbox lock to meet and exceed United States Postal Service specification "USPS-L-1172C"



New Spec Lock has to withstand 1000 lbs. of force applied to the cam. Previous specification was 100 lbs.

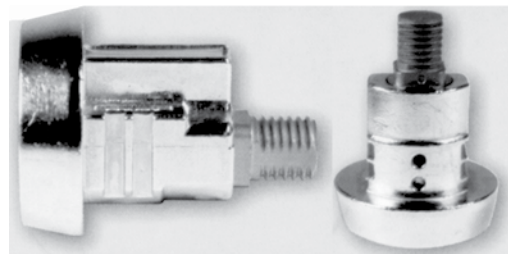

Will retrofit existing NDCBU's (Neighborhood Delivery Collection Box Unit) and CBU's (Cluster Box Unit" with "double D" style cut-out.

The only approved mailbox to fit new USPS-STD-4C boxes.

**C9100, C9200 Features**

- Stainless Steel plug
- 12 degrees taper on cylinder head
- Accommodates up to 3/16" cam
- Drain holes on the bottom of the cylinder
- Includes spring clip, mounting nut and 3 keys
- **C9100 operates CLOCKWISE**
- **C9200 operates COUNTER CLOCKWISE**

The old C8710 - C8735 mailbox locks will not fit into new Standard 4C boxes, they will fit into existing Standard 4B and Standard 4B+ boxes.

Order #	Item #	Catalog Price
605-9100	C9100	<b>\$19.12</b>
605-9200	C9200	<b>19.12</b>



**PRG:  
HUDSON  
PROGRAMMED MKGT**

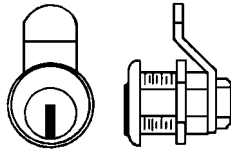

**Comes with Five Cams.**  
**PRG-PT812.** 90° Key. Key removeable in locked position only. US26D. **H20 keyblank.**

685-0812 | PRG-PT812 | **\$11.52**

**BOMMER.  
3-Tumbler Lock**

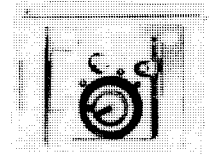

**BOM-25389.** Supplied as a standard on compartment doors of type 560, 500 & 520 mailboxes. Steel bolt and case. Brass tumblers.

145-0200 | BOM-25389 | **\$11.86**



**Pin Tumbler Mailbox Locks**



C8710

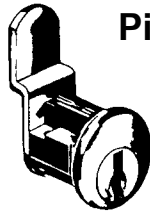

C8711

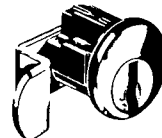

C8713

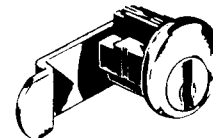

C8714

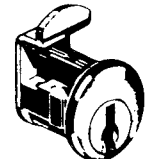

C8715

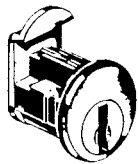

C8716

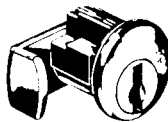

C8717

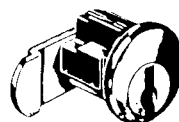

C8718

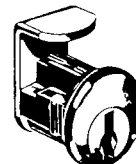

C8719



C8720

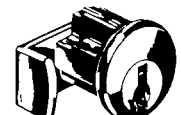

C8721

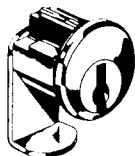

C8722

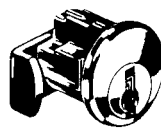

C8723

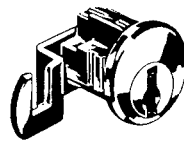

C8724

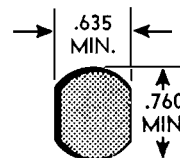

COMPX: National

Order #	National Lock #	Locked Cam Position	Direction of Turn to Open	Replaces
605-8710	C8710	Left	90° c/cw	Bommer Spring Hinge
605-8711	C8711	Up	90° c/cw	Bommer Spring Hinge
605-8713	C8713	Left	90° c/cw	Auth Electric. Also replaces Bommer Lock B25-300 used on Bommer Box 9015 (sleeve inside box must be removed)
605-8714	C8714	Left	90° c/cw	American Device
605-8715	C8715	Up	90° cw	Florence Mfg.
605-8716	C8716	Up	90° cw	S.H. Couch
605-8717	C8717	Left	90° c/cw	Nutone
605-8718	C8718	Left	90° c/cw	Cutler Mail Chute
605-8719	C8719	Up	90° c/cw	Miami-Carey
605-8720	C8720	Down	90° cw	Dura Steel
605-8721	C8721	Left	90° c/cw	Permabilt. XL-201
605-8722	C8722	Down	90° cw	Dura Steel. XL-202
605-8723	C8723	Left	90° c/cw	Jensen General
605-8724	C8724	Left	90° c/cw	Bommer Spring Hinge

Blank: D4291



**GENUINE FACTORY  
REPLACEMENT LOCKS**

**\$9.74 each**

Application: For doors on architectural mail boxes serviced by the US Postal Service. Supplied with two keys and spring mounting clip.

# CABINET LOCKS

[Main Contents](#)   [Index- This Section](#)   [ORDER](#)